

N-Channel Enhancement Mode MOSFET

Features

- 30V/100A,
 $R_{DS(ON)} = 1.45m\Omega$ (max.) @ $V_{GS}=10V$
 $R_{DS(ON)} = 2.15m\Omega$ (max.) @ $V_{GS}=4.5V$
- Reliable and Rugged
- Lead Free and Green Devices Available (RoHS Compliant)
- 100% UIS Tested

Pin Description

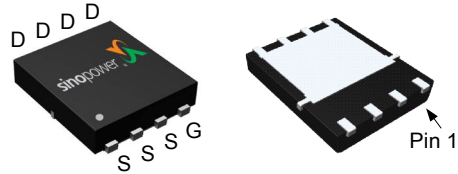

DFN5x6-8

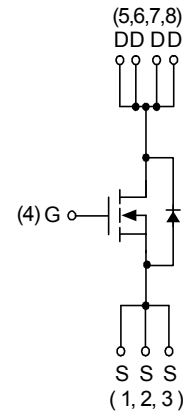

N-Channel MOSFET

Applications

- OR-ing
- Synchronous Rectifier for Server
- Battery Charger and Power Circuits

Ordering and Marking Information

<p>SM4371NS □□□-□□□</p> <div style="margin-left: 20px;"> <p>└─ Assembly Material</p> <p>└─ Handling Code</p> <p>└─ Temperature Range</p> <p>└─ Package Code</p> </div>	<p>Package Code KP : DFN5x6-8</p> <p>Operating Junction Temperature Range C : -55 to 150 °C</p> <p>Handling Code TR : Tape & Reel (2500ea/reel)</p> <p>Assembly Material G : Halogen and Lead Free Device</p>
<p>SM4371NS KP :</p> <div style="border: 1px solid black; padding: 2px; display: inline-block;"> <p>SM4371 XXXXX</p> </div>	<p>XXXXX - Lot Code</p>

Note : SINOPOWER lead-free products contain molding compounds/die attach materials and 100% matte tin plate termination finish; which are fully compliant with RoHS. SINOPOWER lead-free products meet or exceed the lead-free requirements of IPC/JEDEC J-STD-020D for MSL classification at lead-free peak reflow temperature. SINOPOWER defines "Green" to mean lead-free (RoHS compliant) and halogen free (Br or Cl does not exceed 900ppm by weight in homogeneous material and total of Br and Cl does not exceed 1500ppm by weight).

SINOPOWER reserves the right to make changes to improve reliability or manufacturability without notice, and advise customers to obtain the latest version of relevant information to verify before placing orders.

Absolute Maximum Ratings ($T_A = 25^\circ\text{C}$ Unless Otherwise Noted)

Symbol	Parameter	Rating	Unit
Common Ratings			
V_{DSS}	Drain-Source Voltage	30	V
V_{GSS}	Gate-Source Voltage	± 20	
T_J	Maximum Junction Temperature	150	$^\circ\text{C}$
T_{STG}	Storage Temperature Range	-55 to 150	
I_S	Diode Continuous Forward Current	$T_C=25^\circ\text{C}$ 100 ^a	A
I_D	Continuous Drain Current	$T_C=25^\circ\text{C}$ 100 ^a	
		$T_C=100^\circ\text{C}$ 100 ^a	
I_{DM}	Pulsed Drain Current	$T_C=25^\circ\text{C}$ 400 ^b	
P_D	Maximum Power Dissipation	$T_C=25^\circ\text{C}$ 125	W
		$T_C=100^\circ\text{C}$ 50	
$R_{\theta JC}$	Thermal Resistance-Junction to Case	Steady State 1	$^\circ\text{C/W}$
I_D	Continuous Drain Current	$T_A=25^\circ\text{C}$ 32	A
		$T_A=70^\circ\text{C}$ 26	
P_D	Maximum Power Dissipation	$T_A=25^\circ\text{C}$ 2.3	W
		$T_A=70^\circ\text{C}$ 1.5	
$R_{\theta JA}$	Thermal Resistance-Junction to Ambient	$t \leq 10\text{s}$ 17	$^\circ\text{C/W}$
		Steady State 55	
I_{AS}^c	Avalanche Current, Single pulse	$L=0.5\text{mH}$ 41	A
E_{AS}^c	Avalanche Energy, Single pulse	$L=0.5\text{mH}$ 420	mJ

Note a : Package is limited to 100A.

Note b : Pulse width limited by max. junction temperature.

Note c : UIS tested and pulse width limited by maximum junction temperature 150°C (initial temperature $T_J=25^\circ\text{C}$).

Electrical Characteristics (T_A = 25°C unless otherwise noted)

Symbol	Parameter	Test Conditions	Min.	Typ.	Max.	Unit
Static Characteristics						
BV _{DSS}	Drain-Source Breakdown Voltage	V _{GS} =0V, I _{DS} =250μA	30	-	-	V
BV _{DSS(t)}	Drain-Source Breakdown Voltage (transient)	V _{GS} =0V, I _{D(aval)} =40A T _{case} =25°C, t _{transient} =100ns	34	-	-	V
I _{DSS}	Zero Gate Voltage Drain Current	V _{DS} =24V, V _{GS} =0V	-	-	1	μA
		T _J =85°C	-	-	30	
V _{GS(th)}	Gate Threshold Voltage	V _{DS} =V _{GS} , I _{DS} =250μA	1.3	1.7	2.5	V
I _{GSS}	Gate Leakage Current	V _{GS} =±20V, V _{DS} =0V	-	-	±100	nA
R _{DS(ON)} ^d	Drain-Source On-state Resistance	V _{GS} =10V, I _{DS} =40A	-	1.15	1.45	mΩ
		T _J =125°C	-	1.7	-	
		V _{GS} =4.5V, I _{DS} =20A	-	1.65	2.15	
Gfs	Forward Transconductance	V _{DS} =5V, I _{DS} =15A	-	42	-	S
Diode Characteristics						
V _{SD} ^d	Diode Forward Voltage	I _{SD} =20A, V _{GS} =0V	-	0.75	1.1	V
t _{rr}	Reverse Recovery Time	I _F =20A, di _{SD} /dt=100A/μs	-	38	-	ns
t _a	Charge Time		-	20	-	
t _b	Discharge Time		-	18	-	
Q _{rr}	Reverse Recovery Charge		-	34	-	
Dynamic Characteristics^e						
R _G	Gate Resistance	V _{GS} =0V, V _{DS} =0V, F=1MHz	0.6	0.9	1.6	Ω
C _{iss}	Input Capacitance	V _{GS} =0V, V _{DS} =15V, Frequency=1.0MHz	4500	5700	7000	pF
C _{oss}	Output Capacitance		1160	1280	1400	
C _{rss}	Reverse Transfer Capacitance		460	580	700	
t _{d(ON)}	Turn-on Delay Time	V _{DD} =15V, R _L =15Ω, I _{DS} =1A, V _{GEN} =10V, R _G =1Ω	-	22	26	ns
t _r	Turn-on Rise Time		-	12	15	
t _{d(OFF)}	Turn-off Delay Time		-	64	76	
t _f	Turn-off Fall Time		-	45	54	
Gate Charge Characteristics^e						
Q _g	Total Gate Charge	V _{DS} =15V, V _{GS} =4.5V, I _{DS} =40A	-	48	58	nC
Q _g	Total Gate Charge	V _{DS} =15V, V _{GS} =10V, I _{DS} =40A	-	100	120	
Q _{gth}	Threshold Gate Charge		-	4.2	5	
Q _{gs}	Gate-Source Charge		-	11	13	
Q _{gd}	Gate-Drain Charge		-	21	26	

Note d : Pulse test ; pulse width ≤ 300μs, duty cycle ≤ 2%.

Note e : Guaranteed by design, not subject to production testing.

Typical Operating Characteristics

Power Dissipation

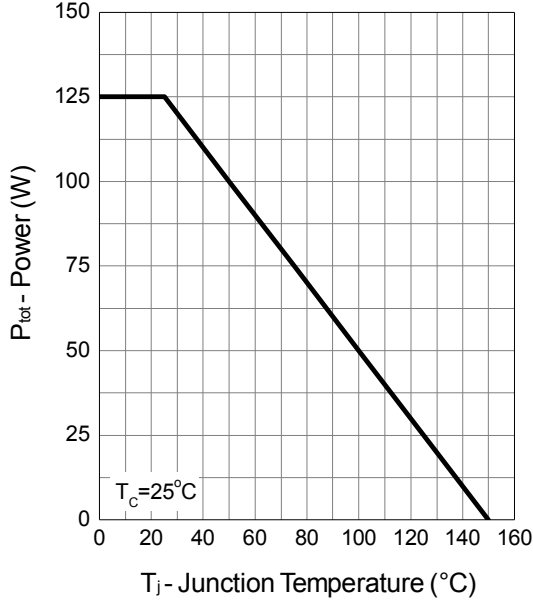

Drain Current

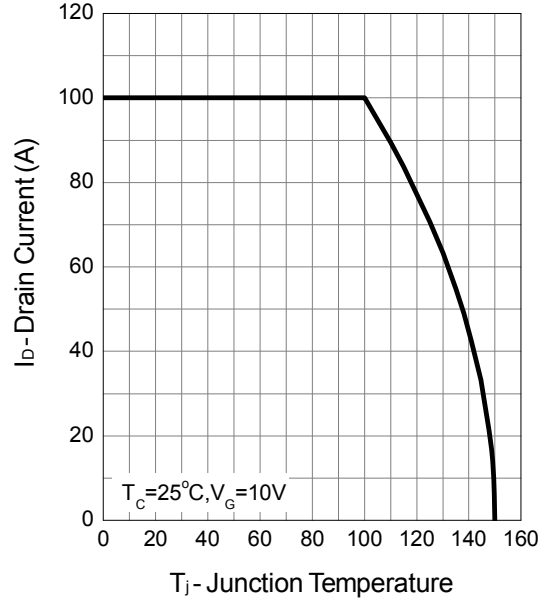

Safe Operation Area

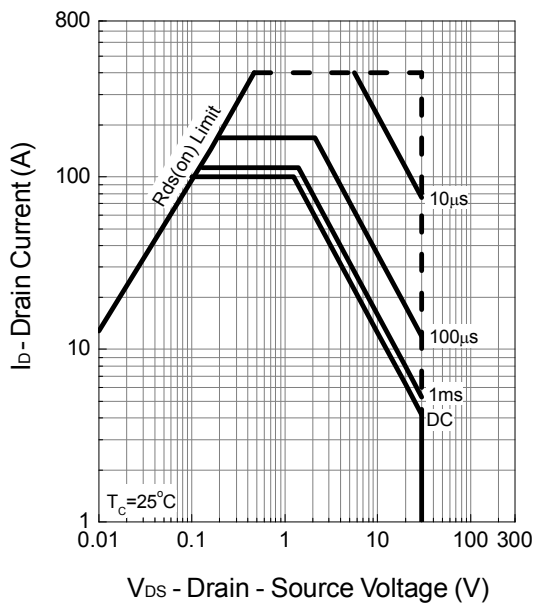

Thermal Transient Impedance

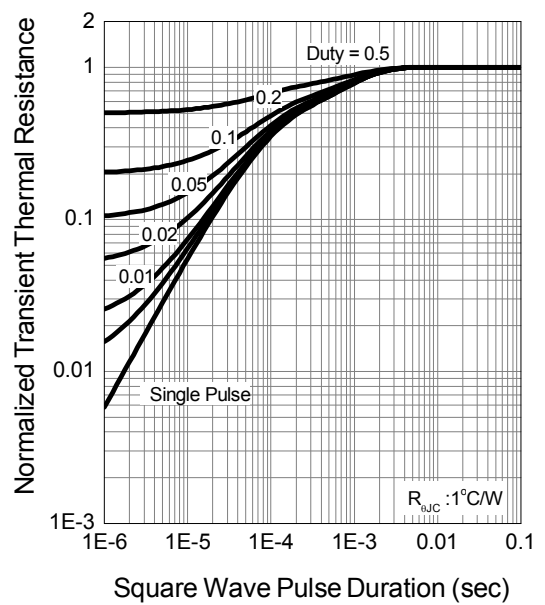

Typical Operating Characteristics (Cont.)

Output Characteristics

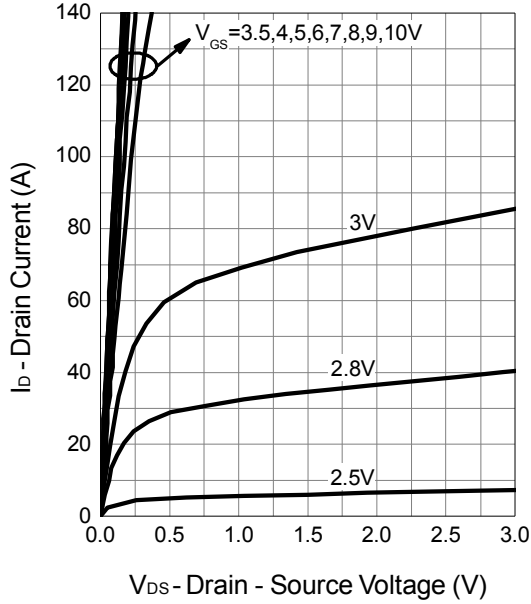

Drain-Source On Resistance

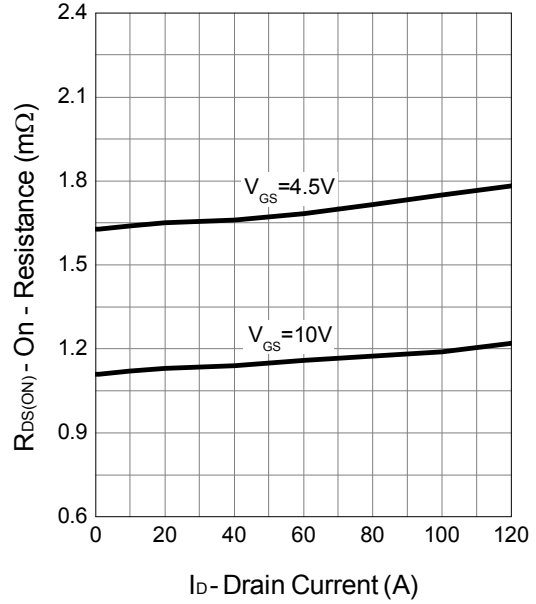

Gate-Source On Resistance

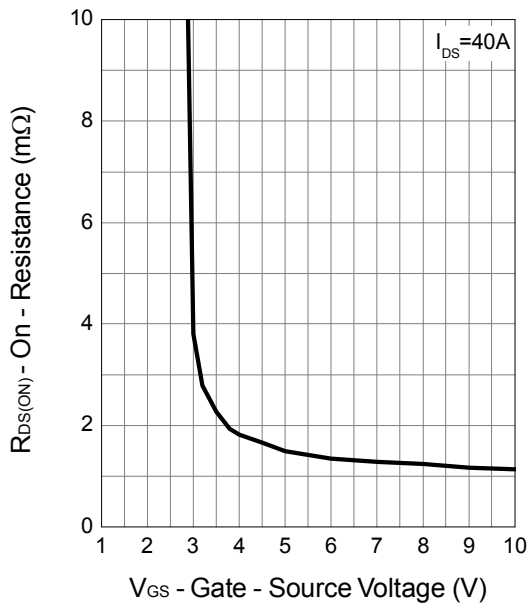

Gate Threshold Voltage

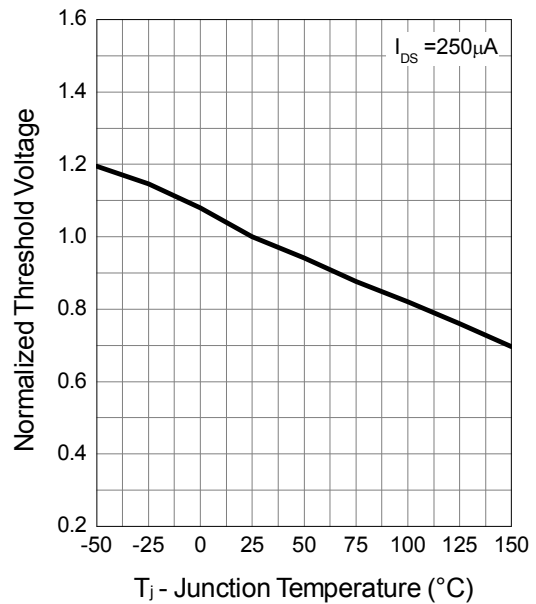

Typical Operating Characteristics (Cont.)

Drain-Source On Resistance

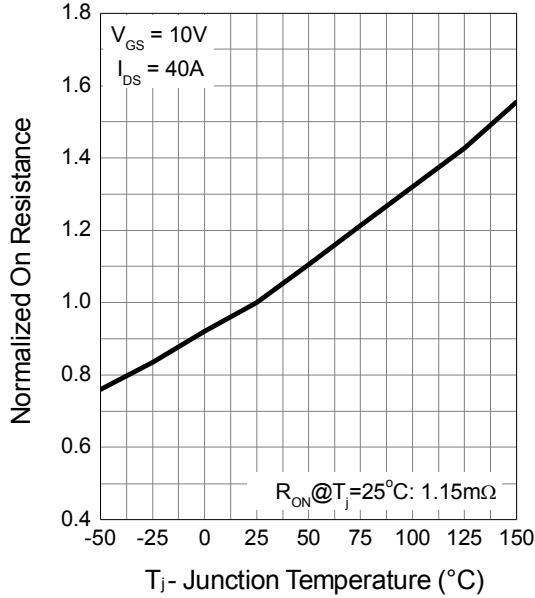

Source-Drain Diode Forward

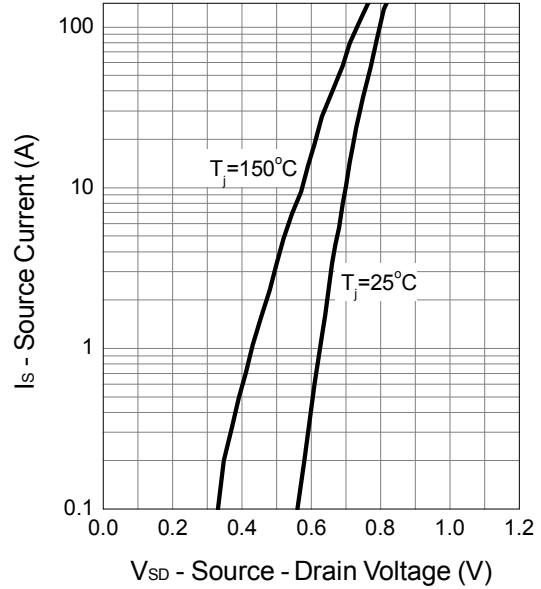

Capacitance

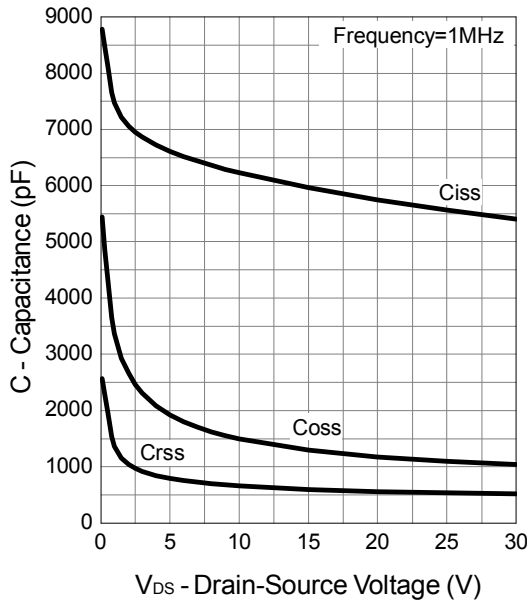

Gate Charge

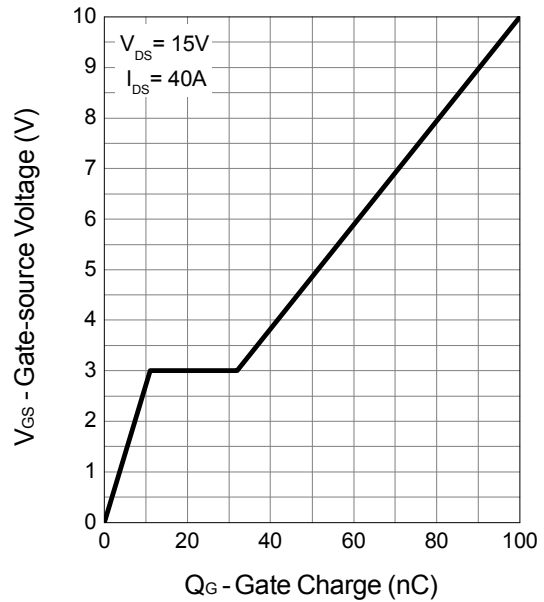

Typical Operating Characteristics (Cont.)

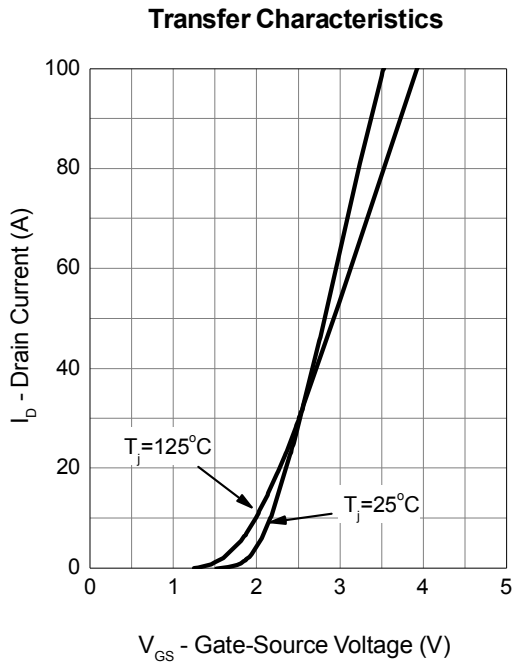

Avalanche Test Circuit and Waveforms

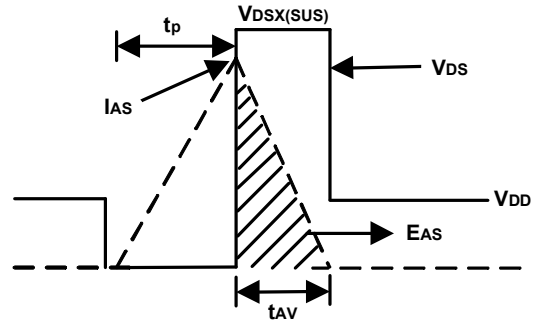
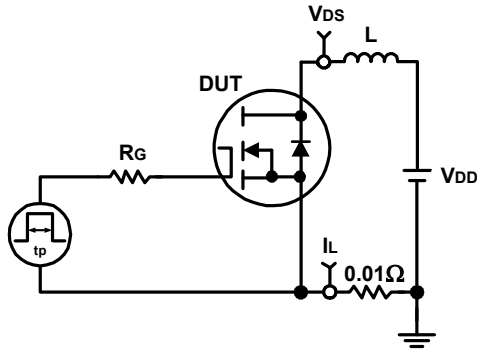

Switching Time Test Circuit and Waveforms

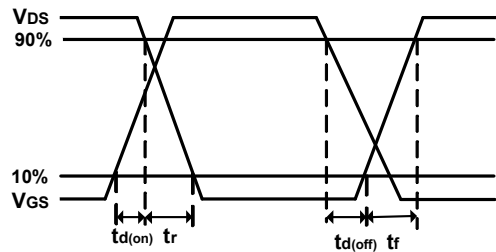
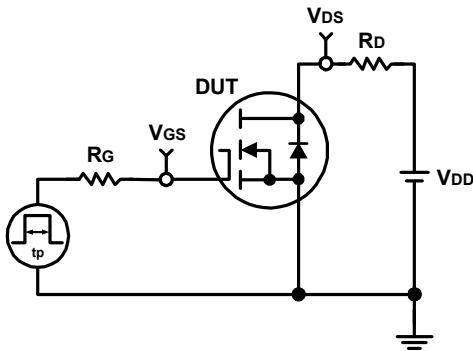

Package Information

DFN5x6-8

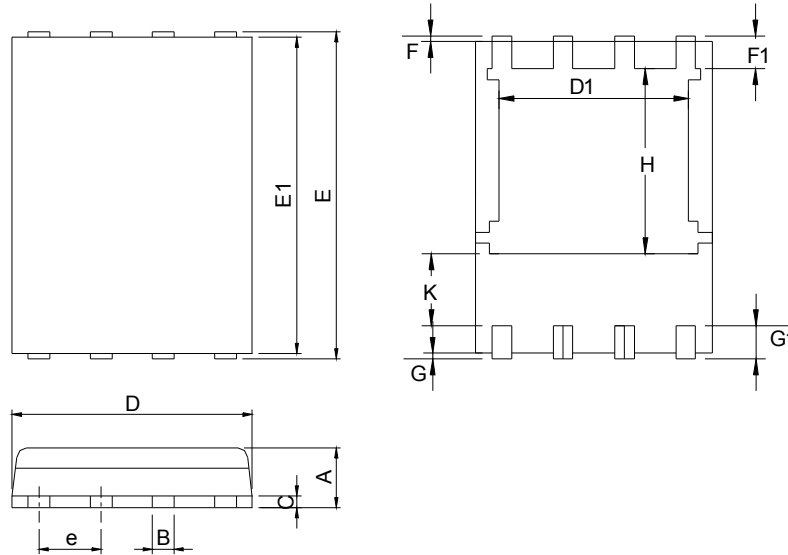

DIMENSIONS	DFN5x6-8			
	MILLIMETERS		INCHES	
	MIN.	MAX.	MIN.	MAX.
A	0.90	1.20	0.035	0.047
B	0.3	0.51	0.012	0.020
C	0.19	0.25	0.007	0.010
D	4.80	5.30	0.189	0.209
D1	4.00	4.40	0.157	0.173
E	5.90	6.20	0.232	0.244
E1	5.50	5.80	0.217	0.228
e	1.27 BSC		0.050 BSC	
F	0.05	0.30	0.002	0.012
F1	0.35	0.75	0.014	0.030
G	0.05	0.30	0.002	0.012
G1	0.35	0.75	0.014	0.030
H	3.34	3.9	0.131	0.154
K	0.762	-	0.03	-

RECOMMENDED LAND PATTERN

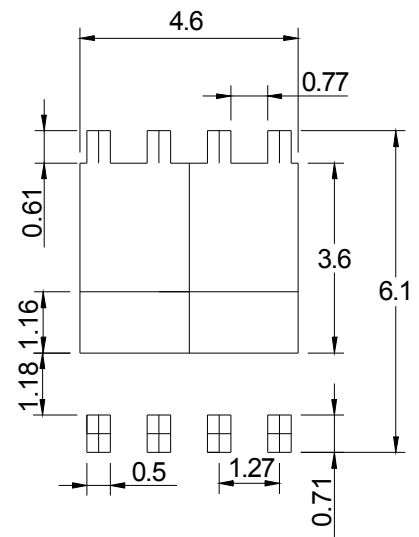

UNIT: mm

Note : 1.Dimension D, D1,D2 and E1 do not include mold flash or protrusions.
Mold flash or protrusions shall not exceed 10 mil.

Carrier Tape & Reel Dimensions

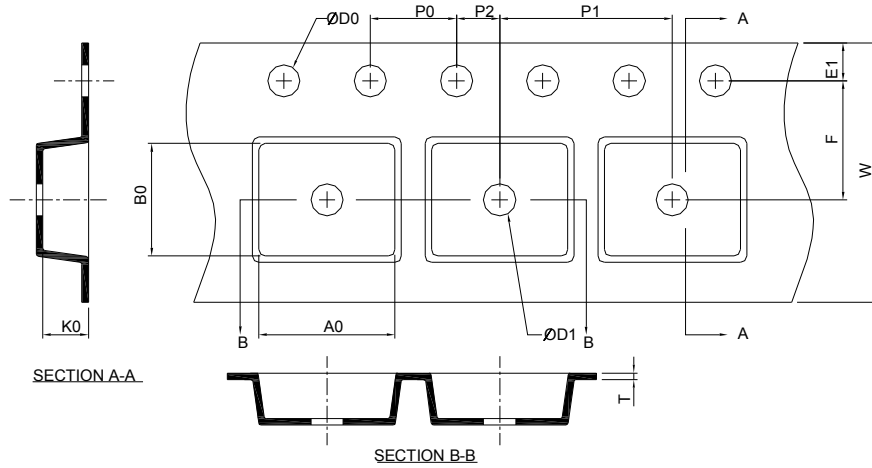

Application	A	H	T1	C	d	D	W	E1	F
DFN5x6-8	330.0±2.00	50 MIN.	12.4+2.00 -0.00	13.0+0.50 -0.20	1.5 MIN.	20.2 MIN.	12.0±0.30	1.75±0.10	5.5±0.10
	P0	P1	P2	D0	D1	T	A0	B0	K0
	4.0±0.10	8.0±0.10	2.0±0.10	1.5+0.10 -0.00	1.5 MIN.	0.3±0.05	6.5±0.10	5.3±0.10	1.4±0.10

(mm)

Taping Direction Information

DFN5x6-8

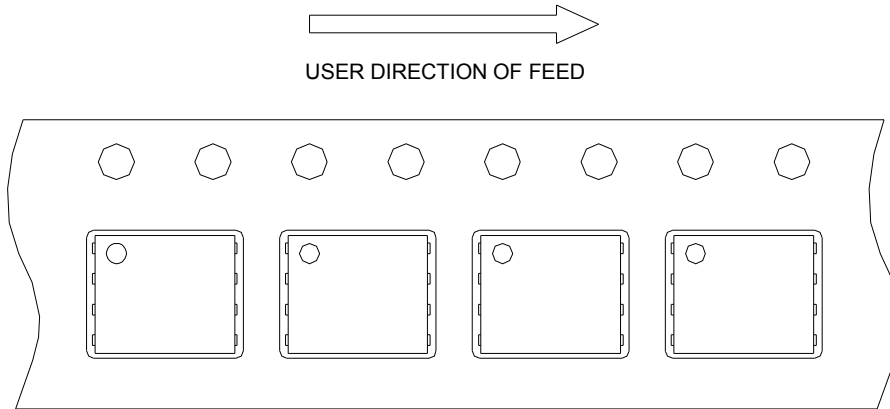

Classification Profile

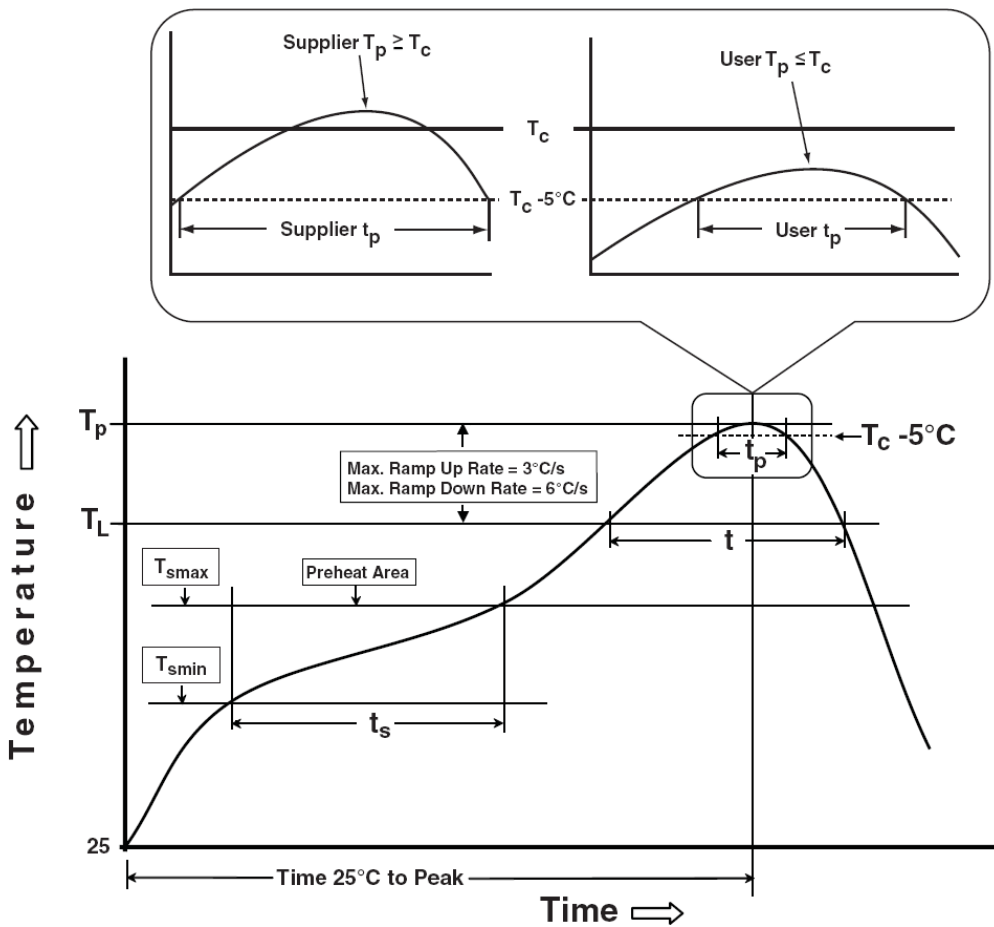

Classification Reflow Profiles

Profile Feature	Sn-Pb Eutectic Assembly	Pb-Free Assembly
Preheat & Soak		
Temperature min (T_{smin})	100 °C	150 °C
Temperature max (T_{smax})	150 °C	200 °C
Time (T_{smin} to T_{smax}) (t_s)	60-120 seconds	60-120 seconds
Average ramp-up rate (T_{smax} to T_p)	3 °C/second max.	3°C/second max.
Liquidous temperature (T_L)	183 °C	217 °C
Time at liquidous (t_L)	60-150 seconds	60-150 seconds
Peak package body Temperature (T_p)*	See Classification Temp in table 1	See Classification Temp in table 2
Time (t_p)** within 5°C of the specified classification temperature (T_c)	20** seconds	30** seconds
Average ramp-down rate (T_p to T_{smax})	6 °C/second max.	6 °C/second max.
Time 25°C to peak temperature	6 minutes max.	8 minutes max.
* Tolerance for peak profile Temperature (T_p) is defined as a supplier minimum and a user maximum. ** Tolerance for time at peak profile temperature (t_p) is defined as a supplier minimum and a user maximum.		

Table 1. SnPb Eutectic Process – Classification Temperatures (T_c)

Package Thickness	Volume mm ³ <350	Volume mm ³ ≥350
<2.5 mm	235 °C	220 °C
≥2.5 mm	220 °C	220 °C

Table 2. Pb-free Process – Classification Temperatures (T_c)

Package Thickness	Volume mm ³ <350	Volume mm ³ 350-2000	Volume mm ³ >2000
<1.6 mm	260 °C	260 °C	260 °C
1.6 mm – 2.5 mm	260 °C	250 °C	245 °C
≥2.5 mm	250 °C	245 °C	245 °C

Reliability Test Program

Test item	Method	Description
SOLDERABILITY	JESD-22, B102	5 Sec, 245°C
HTRB	JESD-22, A108	1000 Hrs, 80% of VDS max @ T_{jmax}
HTGB	JESD-22, A108	1000 Hrs, 100% of VGS max @ T_{jmax}
PCT	JESD-22, A102	168 Hrs, 100%RH, 2atm, 121°C
TCT	JESD-22, A104	500 Cycles, -65°C~150°C

Customer Service

Sinopower Semiconductor, Inc.

5F, No. 6, Dusing 1St Rd., Hsinchu Science Park,

Hsinchu, 30078, Taiwan

TEL: 886-3-5635818 Fax: 886-3-5642050