

N-Channel Enhancement Mode MOSFET

Features

- 30V/50A,
 $R_{DS(ON)} = 7m\Omega$ (max.) @ $V_{GS} = 10V$
 $R_{DS(ON)} = 9.6m\Omega$ (max.) @ $V_{GS} = 4.5V$
- Provide Excellent Qgd x Rds-on
- Reliable and Rugged
- Lead Free and Green Devices Available
(RoHS Compliant)
- 100% E_{AS} (UIS) test

Applications

- Power Management in Desktop Computer or DC/DC Converters.

Pin Description

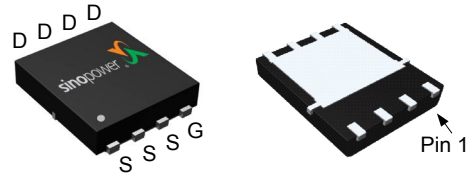

DFN5x6-8

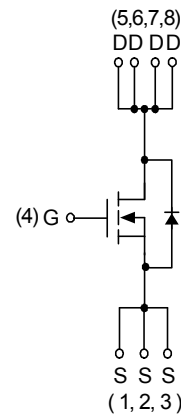

N-Channel MOSFET

Ordering and Marking Information

<p>SM4377NS □□□-□□□</p> <div style="margin-left: 20px;"> <p>└─ Assembly Material</p> <p>└─ Handling Code</p> <p>└─ Temperature Range</p> <p>└─ Package Code</p> </div>	<p>Package Code KP : DFN5x6-8</p> <p>Operating Junction Temperature Range C : -55 to 150 °C</p> <p>Handling Code TR : Tape & Reel (2500ea/reel)</p> <p>Assembly Material G : Halogen and Lead Free Device</p>
<p>SM4377NS KP :</p> <div style="border: 1px solid black; padding: 2px; display: inline-block; margin-left: 10px;">  </div>	<p>XXXXX - Lot Code</p>

Note : SINOPOWER lead-free products contain molding compounds/die attach materials and 100% matte tin plate termination finish; which are fully compliant with RoHS. SINOPOWER lead-free products meet or exceed the lead-free requirements of IPC/JEDEC J-STD-020D for MSL classification at lead-free peak reflow temperature. SINOPOWER defines "Green" to mean lead-free (RoHS compliant) and halogen free (Br or Cl does not exceed 900ppm by weight in homogeneous material and total of Br and Cl does not exceed 1500ppm by weight).

SINOPOWER reserves the right to make changes to improve reliability or manufacturability without notice, and advise customers to obtain the latest version of relevant information to verify before placing orders.

Absolute Maximum Ratings (T_A = 25°C Unless Otherwise Noted)

Symbol	Parameter	Rating	Unit	
Common Ratings				
V _{DSS}	Drain-Source Voltage	30	V	
V _{GSS}	Gate-Source Voltage	±20		
T _J	Maximum Junction Temperature	150	°C	
T _{STG}	Storage Temperature Range	-55 to 150	°C	
I _S	Diode Continuous Forward Current	30	A	
I _{DP}	300µs Pulse Drain Current Tested	T _C =25°C	120	A
		T _C =100°C	85	
I _D ^a	Continuous Drain Current	T _C =25°C	50*	A
		T _C =100°C	35	
P _D	Maximum Power Dissipation	T _C =25°C	32	W
		T _C =100°C	12.8	
R _{θJC}	Thermal Resistance-Junction to Case	Steady State	3.9	°C/W
R _{θJA}	Thermal Resistance-Junction to Ambient	t ≤ 10s	20	°C/W
		Steady State	45	
I _{AS} ^b	Avalanche Current, Single pulse	L=0.1mH	25	A
		L=0.3mH	19	
		L=0.5mH	14	
E _{AS} ^b	Avalanche Energy, Single pulse	L=0.1mH	31	mJ
		L=0.3mH	54	
		L=0.5mH	50	

Note a : * Current limited by bond wire.

Note b : UIS tested and pulse width limited by maximum junction temperature 150°C (initial temperature T_J=25°C).

Electrical Characteristics ($T_A = 25^\circ\text{C}$ unless otherwise noted)

Symbol	Parameter	Test Conditions	Min.	Typ.	Max.	Unit
Static Characteristics						
BV_{DSS}	Drain-Source Breakdown Voltage	$V_{GS}=0V, I_{DS}=250\mu A$	30	-	-	V
BV_{DSSt}	Drain-Source Breakdown Voltage (transient)	$V_{GS}=0V, I_{D(aval)}=10A$ $T_{case}=25^\circ C, t_{transient}=100ns$	34	-	-	V
I_{DSS}	Zero Gate Voltage Drain Current	$V_{DS}=24V, V_{GS}=0V$	-	-	1	μA
		$T_J=85^\circ C$	-	-	30	
$V_{GS(th)}$	Gate Threshold Voltage	$V_{DS}=V_{GS}, I_{DS}=250\mu A$	1.5	1.8	2.5	V
I_{GSS}	Gate Leakage Current	$V_{GS}=\pm 20V, V_{DS}=0V$	-	-	± 100	nA
$R_{DS(ON)}^c$	Drain-Source On-state Resistance	$V_{GS}=10V, I_{DS}=30A$	-	5.6	7	m Ω
		$T_J=125^\circ C$	-	8.4	-	
		$V_{GS}=4.5V, I_{DS}=15A$	-	7.4	9.6	
Gfs	Forward Transconductance	$V_{DS}=5V, I_{DS}=30A$	-	70	-	S
Diode Characteristics						
V_{SD}^c	Diode Forward Voltage	$I_{SD}=15A, V_{GS}=0V$	-	0.85	1.1	V
t_{rr}	Reverse Recovery Time	$I_{DS}=15A, di_{SD}/dt=100A/\mu s$	-	20	-	ns
t_a	Charge Time		-	11	-	
t_b	Discharge Time		-	9	-	
Q_{rr}	Reverse Recovery Charge		-	10	-	
Dynamic Characteristics ^d						
R_G	Gate Resistance	$V_{GS}=0V, V_{DS}=0V, F=1MHz$	0.7	1	1.5	Ω
C_{iss}	Input Capacitance	$V_{GS}=0V,$ $V_{DS}=15V,$ Frequency=1.0MHz	980	1180	1400	pF
C_{oss}	Output Capacitance		158	190	228	
C_{riss}	Reverse Transfer Capacitance		90	115	140	
$t_{d(ON)}$	Turn-on Delay Time	$V_{DD}=15V, R_L=15\Omega,$ $I_{DS}=1A, V_{GEN}=10V,$ $R_G=6\Omega$	-	11	20	ns
t_r	Turn-on Rise Time		-	12	22	
$t_{d(OFF)}$	Turn-off Delay Time		-	36	60	
t_f	Turn-off Fall Time		-	10	19	
Gate Charge Characteristics ^d						
Q_g	Total Gate Charge	$V_{DS}=15V, V_{GS}=4.5V,$ $I_{DS}=30A$	-	10	12	nC
Q_g	Total Gate Charge	$V_{DS}=15V, V_{GS}=10V,$ $I_{DS}=30A$	-	20	24	
Q_{gth}	Threshold Gate Charge		-	2.2	2.7	
Q_{gs}	Gate-Source Charge		-	3.5	4.1	
Q_{gd}	Gate-Drain Charge		-	4.2	4.7	

Note c : Pulse test ; pulse width $\leq 300\mu s$, duty cycle $\leq 2\%$.

Note d : Guaranteed by design, not subject to production testing.

Typical Operating Characteristics

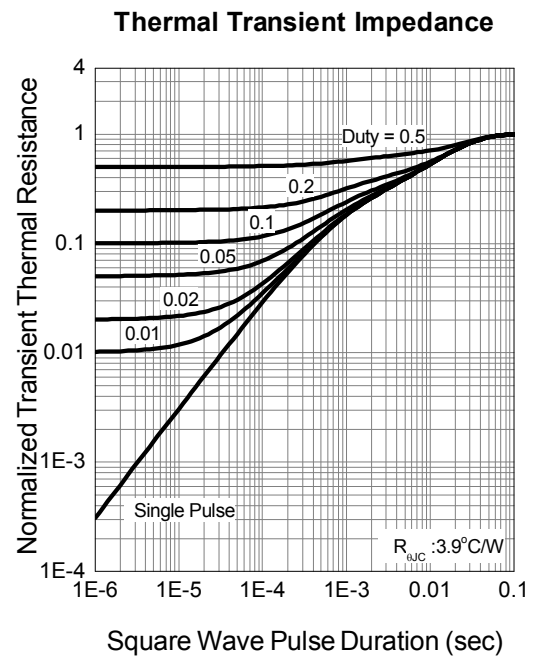
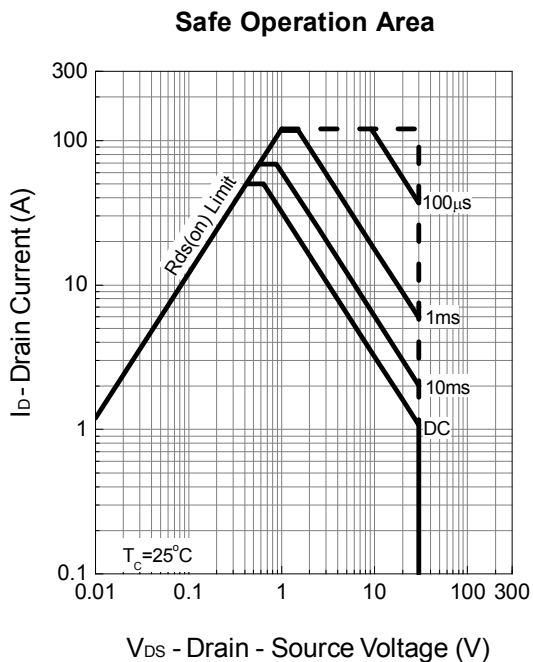
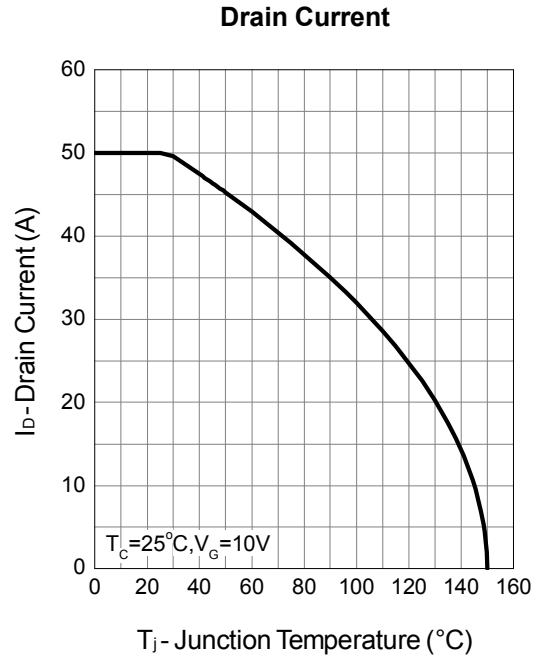
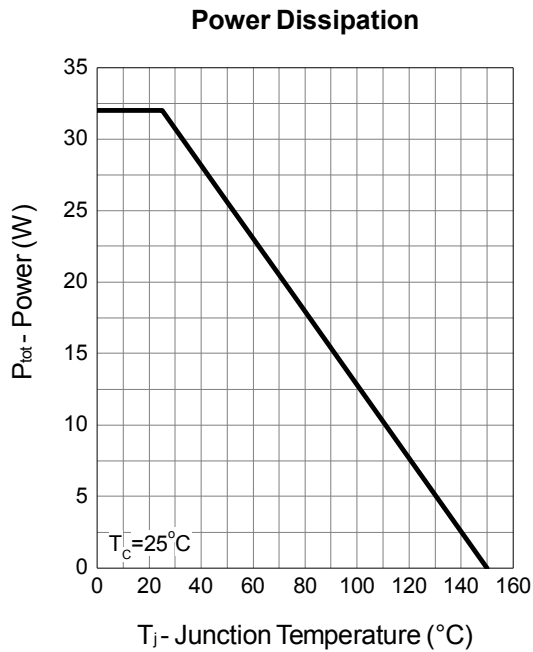

Typical Operating Characteristics (Cont.)

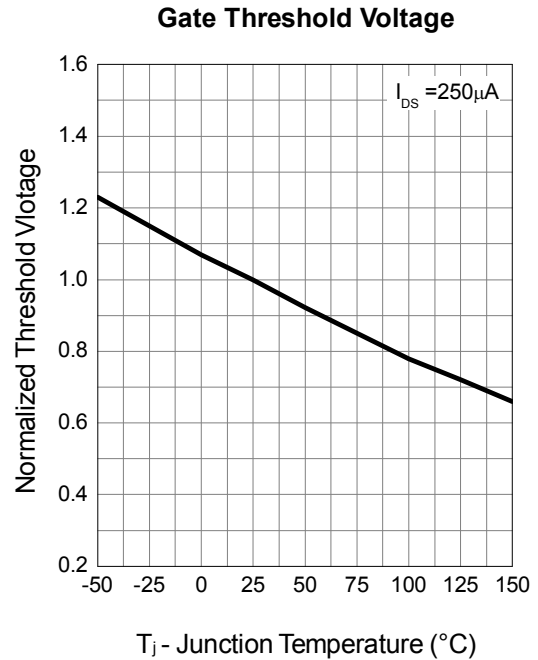
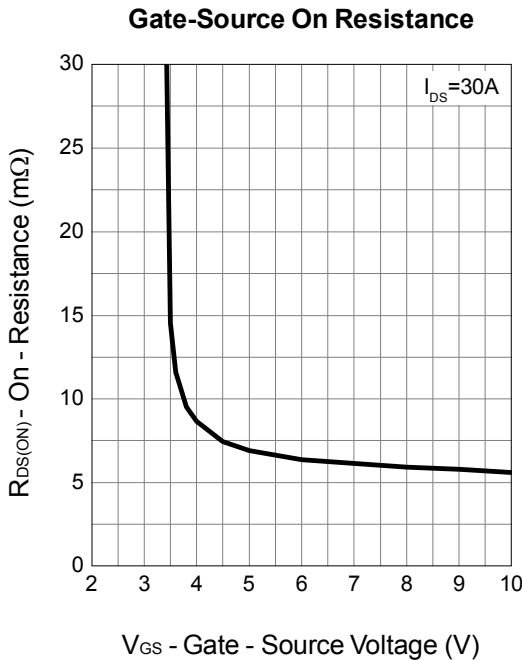
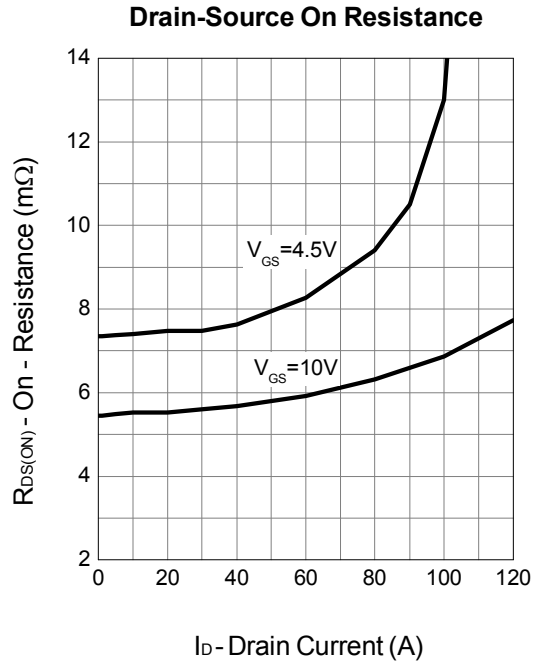
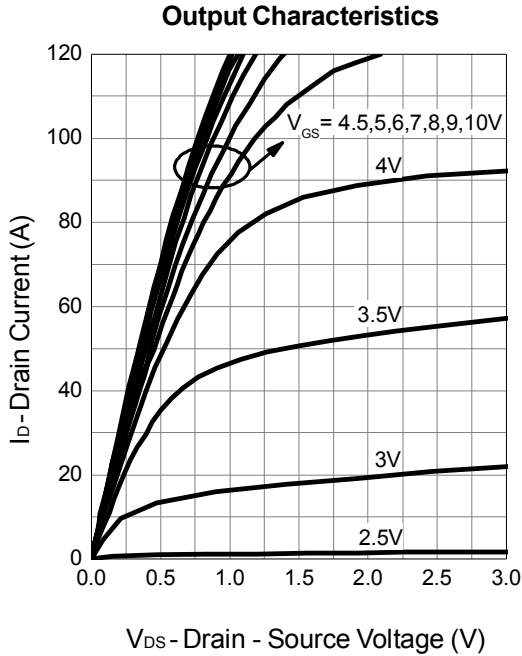

Typical Operating Characteristics (Cont.)

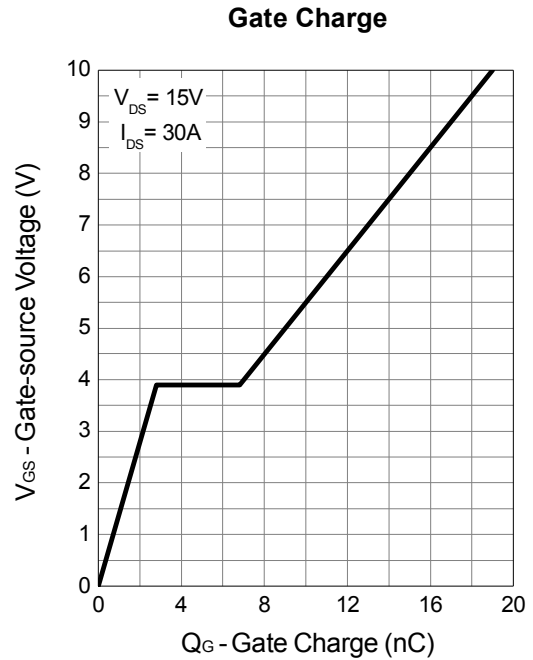
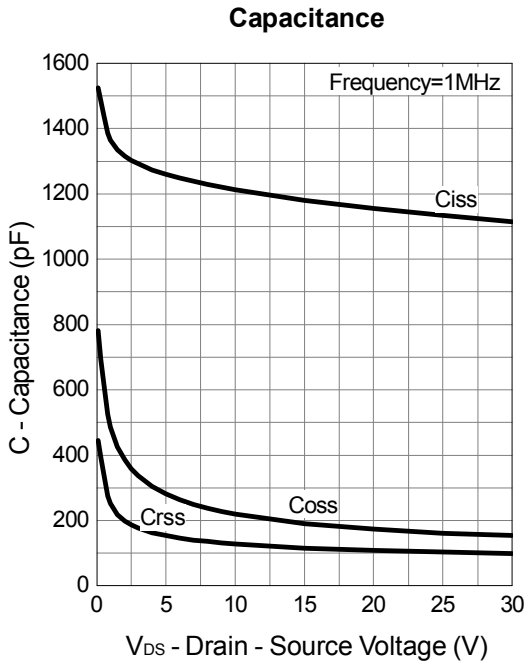
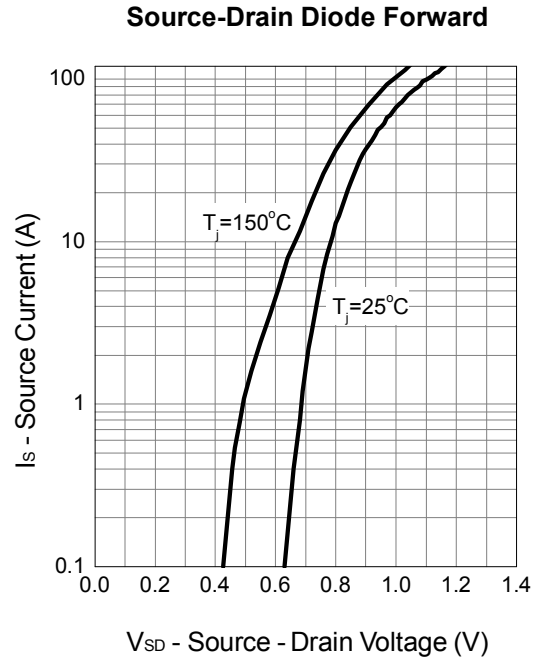
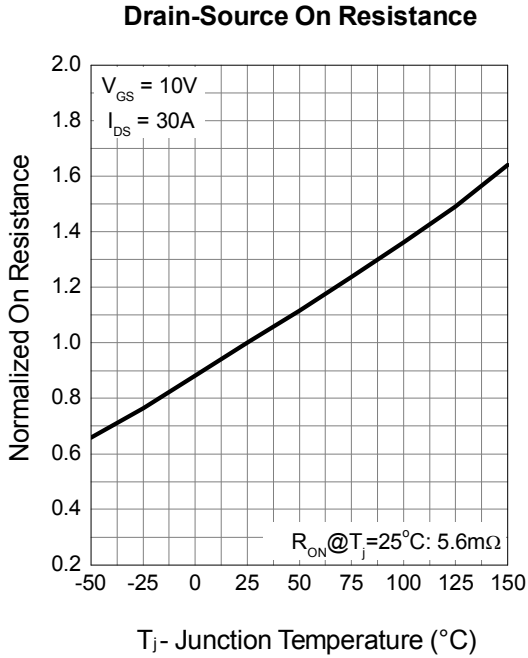

Typical Operating Characteristics (Cont.)

Transfer Characteristics

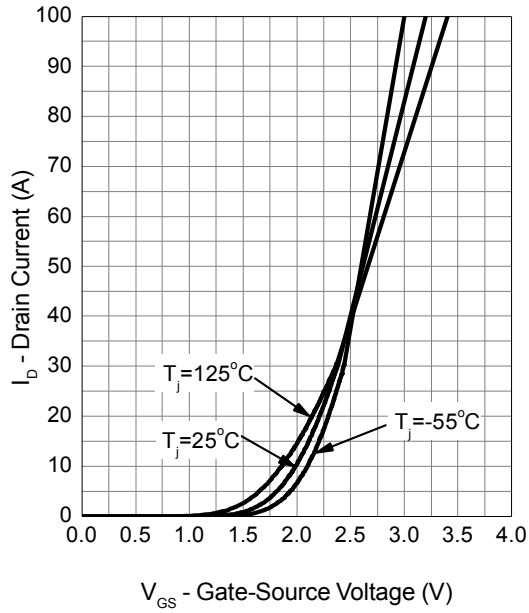

Avalanche Test Circuit and Waveforms

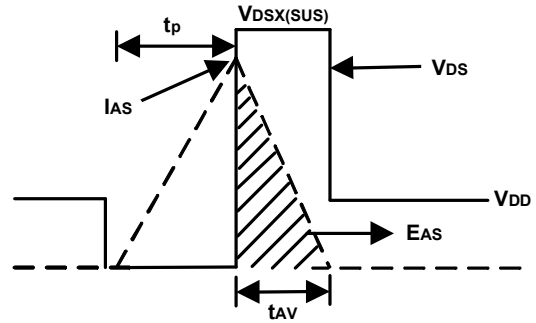
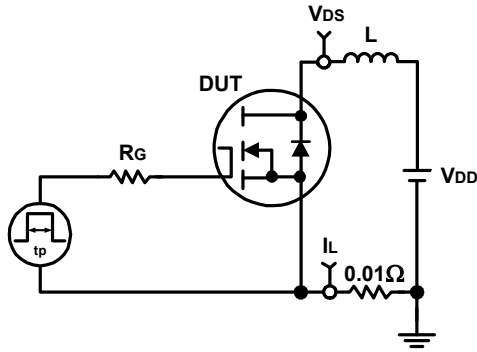

Switching Time Test Circuit and Waveforms

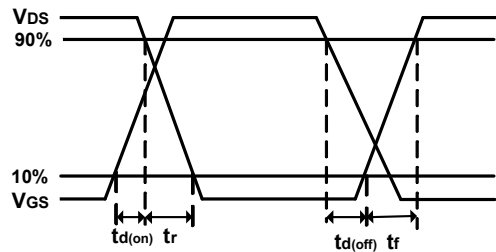
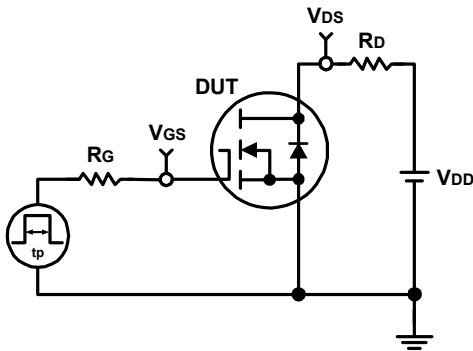

Package Information

DFN5x6-8

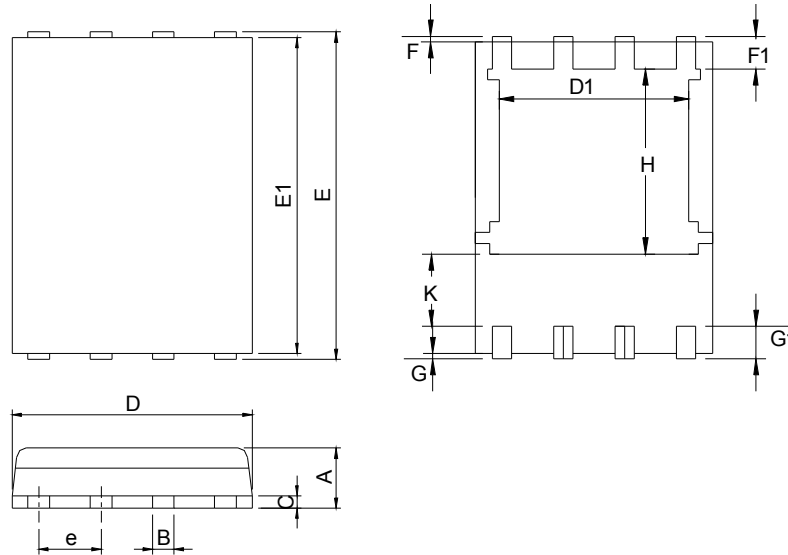

SYMBOL	DFN5x6-8			
	MILLIMETERS		INCHES	
	MIN.	MAX.	MIN.	MAX.
A	0.90	1.20	0.035	0.047
B	0.3	0.51	0.012	0.020
C	0.19	0.25	0.007	0.010
D	4.80	5.30	0.189	0.209
D1	4.00	4.40	0.157	0.173
E	5.90	6.20	0.232	0.244
E1	5.50	5.80	0.217	0.228
e	1.27 BSC		0.050 BSC	
F	0.05	0.30	0.002	0.012
F1	0.35	0.75	0.014	0.030
G	0.05	0.30	0.002	0.012
G1	0.35	0.75	0.014	0.030
H	3.34	3.9	0.131	0.154
K	0.762	-	0.03	-

RECOMMENDED LAND PATTERN

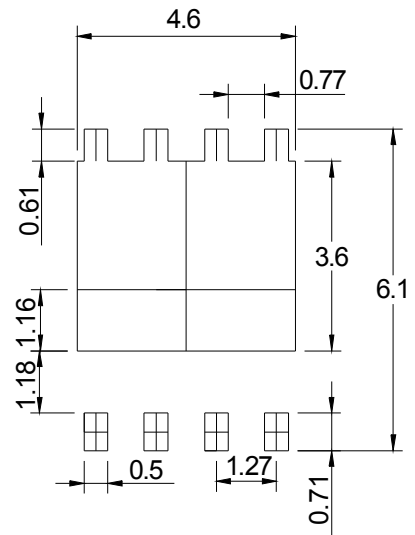

UNIT: mm

Note : 1.Dimension D, D1,D2 and E1 do not include mold flash or protrusions.
Mold flash or protrusions shall not exceed 10 mil.

Carrier Tape & Reel Dimensions

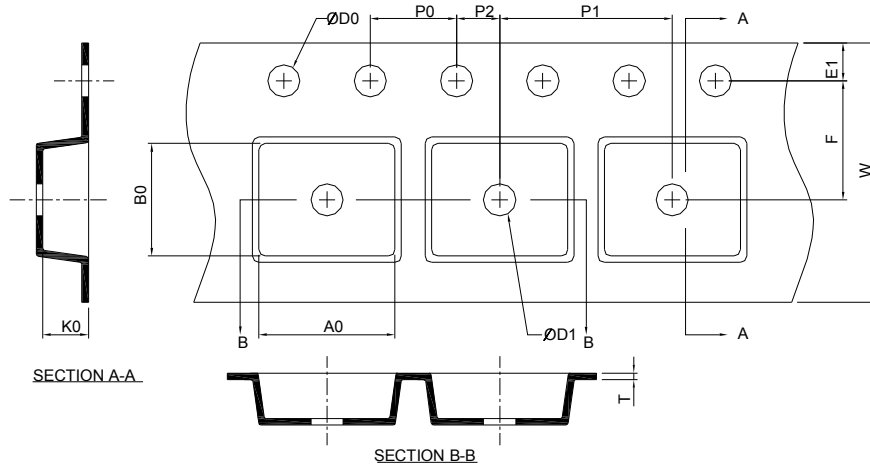

Application	A	H	T1	C	d	D	W	E1	F
DFN5x6-8	330.0±2.00	50 MIN.	12.4+2.00 -0.00	13.0+0.50 -0.20	1.5 MIN.	20.2 MIN.	12.0±0.30	1.75±0.10	5.5±0.10
	P0	P1	P2	D0	D1	T	A0	B0	K0
	4.0±0.10	8.0±0.10	2.0±0.10	1.5+0.10 -0.00	1.5 MIN.	0.3±0.05	6.5±0.10	5.3±0.10	1.4±0.10

(mm)

Taping Direction Information

DFN5x6-8

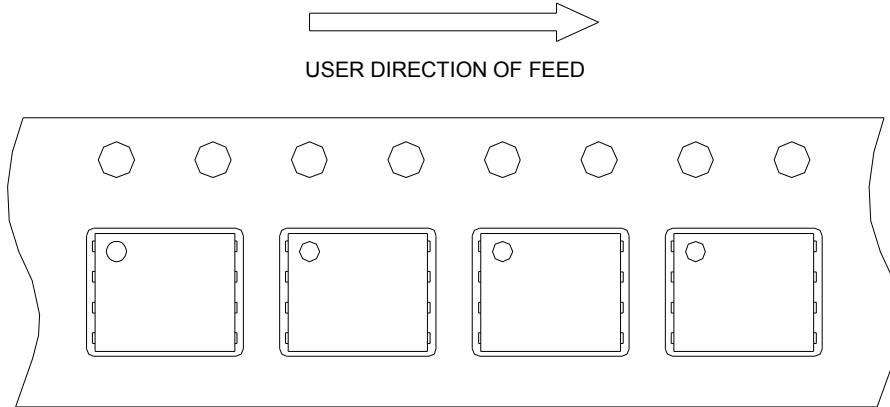

Classification Profile

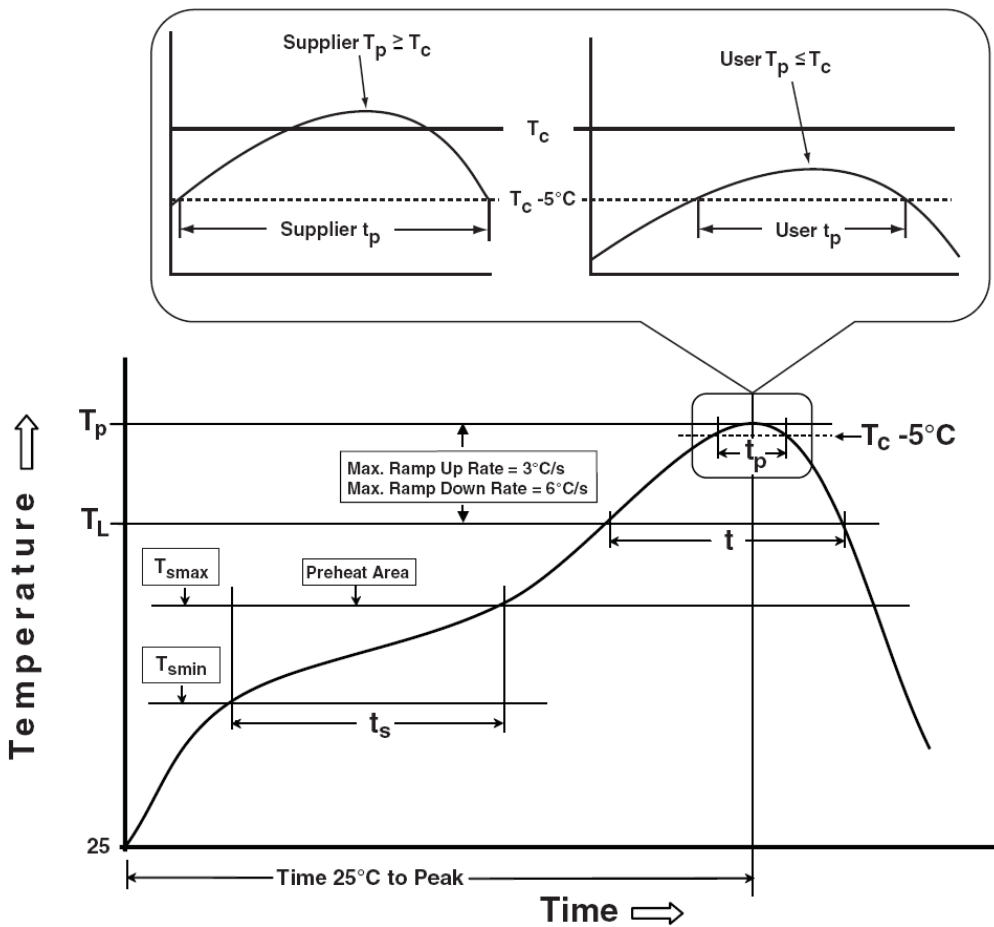

Classification Reflow Profiles

Profile Feature	Sn-Pb Eutectic Assembly	Pb-Free Assembly
Preheat & Soak		
Temperature min (T_{smin})	100 °C	150 °C
Temperature max (T_{smax})	150 °C	200 °C
Time (T_{smin} to T_{smax}) (t_s)	60-120 seconds	60-120 seconds
Average ramp-up rate (T_{smax} to T_p)	3 °C/second max.	3°C/second max.
Liquidous temperature (T_L)	183 °C	217 °C
Time at liquidous (t_L)	60-150 seconds	60-150 seconds
Peak package body Temperature (T_p)*	See Classification Temp in table 1	See Classification Temp in table 2
Time (t_p)** within 5°C of the specified classification temperature (T_c)	20** seconds	30** seconds
Average ramp-down rate (T_p to T_{smax})	6 °C/second max.	6 °C/second max.
Time 25°C to peak temperature	6 minutes max.	8 minutes max.
* Tolerance for peak profile Temperature (T_p) is defined as a supplier minimum and a user maximum. ** Tolerance for time at peak profile temperature (t_p) is defined as a supplier minimum and a user maximum.		

Table 1. SnPb Eutectic Process – Classification Temperatures (T_c)

Package Thickness	Volume mm ³ <350	Volume mm ³ ≥350
<2.5 mm	235 °C	220 °C
≥2.5 mm	220 °C	220 °C

Table 2. Pb-free Process – Classification Temperatures (T_c)

Package Thickness	Volume mm ³ <350	Volume mm ³ 350-2000	Volume mm ³ >2000
<1.6 mm	260 °C	260 °C	260 °C
1.6 mm – 2.5 mm	260 °C	250 °C	245 °C
≥2.5 mm	250 °C	245 °C	245 °C

Reliability Test Program

Test item	Method	Description
SOLDERABILITY	JESD-22, B102	5 Sec, 245°C
HTRB	JESD-22, A108	1000 Hrs, 80% of VDS max @ T_{jmax}
HTGB	JESD-22, A108	1000 Hrs, 100% of VGS max @ T_{jmax}
PCT	JESD-22, A102	168 Hrs, 100%RH, 2atm, 121°C
TCT	JESD-22, A104	500 Cycles, -65°C~150°C

Customer Service

Sinopower Semiconductor, Inc.

5F, No. 6, Dusing 1St Rd., Hsinchu Science Park,

Hsinchu, 30078, Taiwan

TEL: 886-3-5635818 Fax: 886-3-5642050