



1.0A GENERAL PURPOSE RECTIFIERS - 50V- 1000V SMA-L PACKAGE

Features

- Batch process design, excellent power dissipation offers better reverse leakage current and thermal resistance.
- Low profile surface mounted application in order to optimize board space.
- High current capability.
- High surge capability.
- Glass passivated chip junction.
- **Moisture Sensitivity Level 1**

Package outline

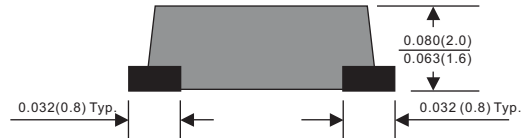
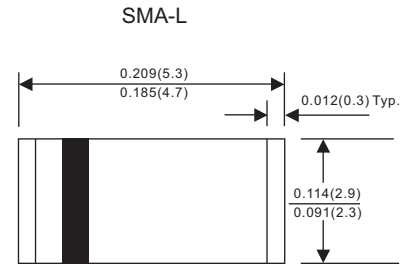

Dimensions in inches and (millimeters)

Mechanical data

- Epoxy:UL94-V0 rated flame retardant
- Case : Molded plastic, SMA-L
- Terminals : Solder plated, solderable per MIL-STD-750, Method 2026
- Polarity : Indicated by cathode band
- Mounting Position : Any
- Weight : Approximated 0.05 gram

Maximum ratings and Electrical Characteristics (AT $T_A=25^{\circ}\text{C}$ unless otherwise noted)

PARAMETER	CONDITIONS	Symbol	MIN.	TYP.	MAX.	UNIT
Forward rectified current	See Fig.2	I_o			1.0	A
Forward surge current	8.3ms single half sine-wave superimposed on rate load (JEDEC methode)	I_{FSM}			30	A
Reverse current	$V_R = V_{RRM} \quad T_J = 25^{\circ}\text{C}$	I_R			5.0	μA
	$V_R = V_{RRM} \quad T_J = 125^{\circ}\text{C}$				50	
Diode junction capacitance	$f=1\text{MHz}$ and applied 4V DC reverse voltage	C_J		15		pF
Storage temperature		T_{STG}	-55		+150	$^{\circ}\text{C}$

SYMBOLS	V_{RRM}^{*1} (V)	V_{RMS}^{*2} (V)	V_R^{*3} (V)	V_F^{*4} (V)	Operating temperature $T_J, (^{\circ}\text{C})$
FM4001L	50	35	50	1.10	-55 to +150
FM4002L	100	70	100		
FM4003L	200	140	200		
FM4004L	400	280	400		
FM4005L	600	420	600		
FM4006L	800	560	800		
FM4007L	1000	700	1000		

*1 Repetitive peak reverse voltage

*2 RMS voltage

*3 Continuous reverse voltage

*4 Maximum forward voltage@ $I_F=1.0\text{A}$



Rating and characteristic curves

FIG.1-TYPICAL FORWARD CHARACTERISTICS

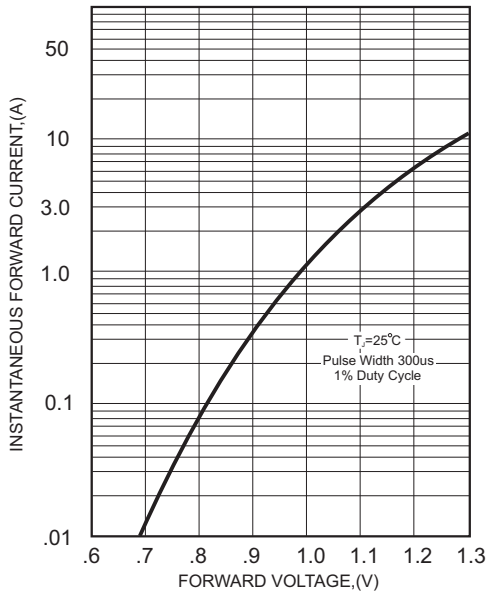

FIG.2-TYPICAL FORWARD CURRENT DERATING CURVE

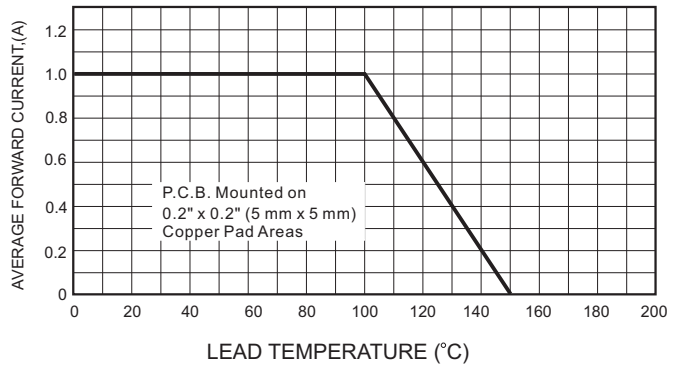

FIG.4-MAXIMUM NON-REPETITIVE FORWARD SURGE CURRENT

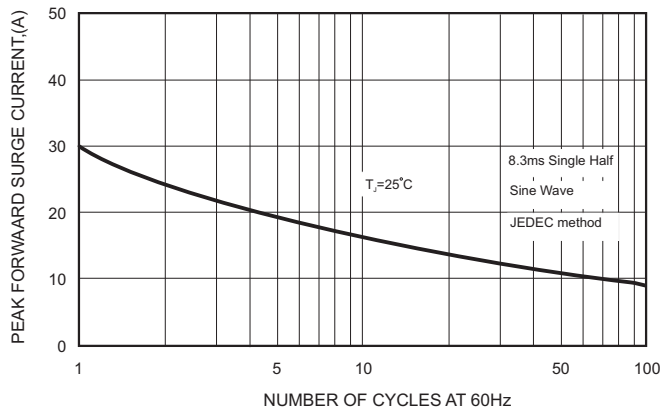

FIG.3 - TYPICAL REVERSE CHARACTERISTICS

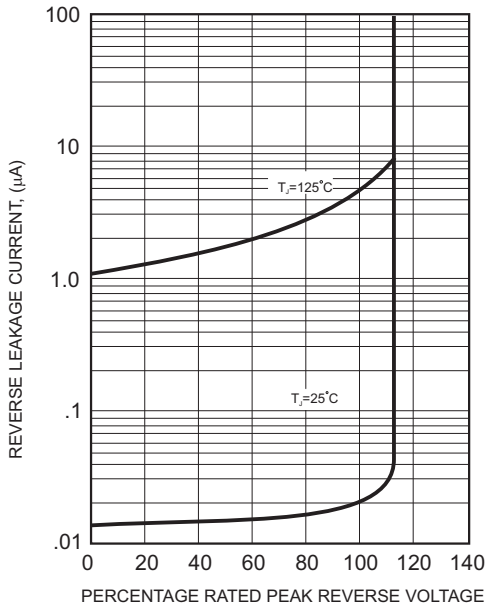
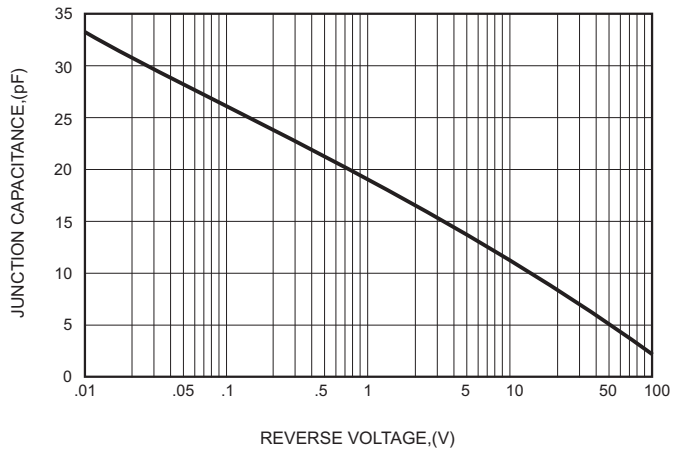

FIG.5-TYPICAL JUNCTION CAPACITANCE





1.0A GENERAL PURPOSE RECTIFIERS - 50V- 1000V SMA-L PACKAGE

Pinning information

Pin	Simplified outline	Symbol
Pin1 cathode Pin2 anode		

Reel packing

PACKAGE	REEL SIZE	REEL (pcs)	COMPONENT SPACING (m/m)	BOX (pcs)	INNER BOX (m/m)	REEL DIA. (m/m)	CARTON SIZE (m/m)	CARTON (pcs)	APPROX. GROSS WEIGHT (kg)
SMA-L	7"	2,000	4.0	20,000	183*170*183	178	382*356*387	160,000	15.5
SMA-L	13"	7,500	4.0	15,000	337*337*37	330	350*330*360	120,000	14.2

Marking

Type number	Marking code
FM4001L	A1
FM4002L	A2
FM4003L	A3
FM4004L	A4
FM4005L	A5
FM4006L	A6
FM4007L	A7

Pb-Free package is available

RoHS product for packing code suffix "G"

Halogen free product for packing code suffix "H"

Suggested solder pad layout

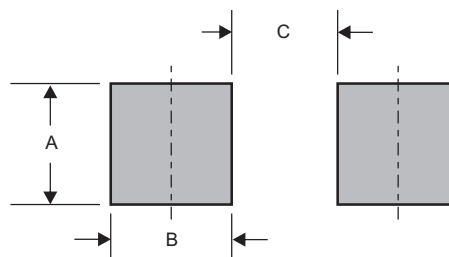

Dimensions in inches and (millimeters)

PACKAGE	A	B	C
SMA-L	0.110 (2.80)	0.059 (1.50)	0.110 (2.80)



1.0A GENERAL PURPOSE RECTIFIERS - 50V- 1000V SMA-L PACKAGE

Packing information

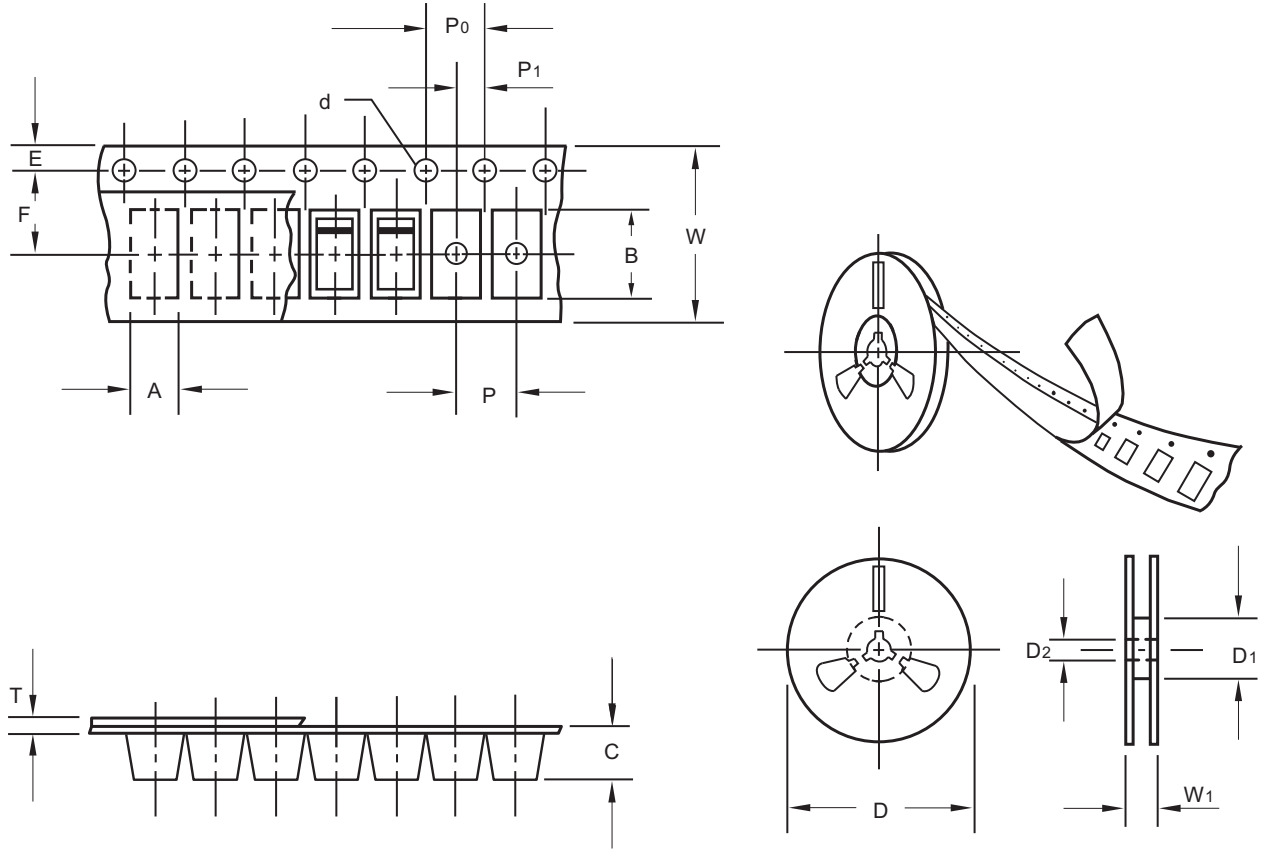

unit:mm

Item	Symbol	Tolerance	SMA-L
Carrier width	A	0.1	2.90
Carrier length	B	0.1	5.50
Carrier depth	C	0.1	2.10
Sprocket hole	d	0.1	1.50
13" Reel outside diameter	D	2.0	330.00
13" Reel inner diameter	D1	min	50.00
7" Reel outside diameter	D	2.0	178.00
7" Reel inner diameter	D1	min	62.00
Feed hole diameter	D2	0.5	13.00
Sprocket hole position	E	0.1	1.75
Punch hole position	F	0.1	5.50
Punch hole pitch	P	0.1	4.00
Sprocket hole pitch	P0	0.1	4.00
Embossment center	P1	0.1	2.00
Overall tape thickness	T	0.1	0.23
Tape width	W	0.3	12.00
Reel width	W1	1.0	18.00

Note: Devices are packed in accordance with EIA standard RS-481-A and specifications listed above.



Ordering Information:

Device PN	Packing	
Part Number -T ⁽¹⁾ G ⁽²⁾ -WS	T	Tape & 7" Reel Packing :2000pcs/Reel
	W	Tape & 13" Reel Packing :7500pcs/Reel

Note: 1. Packing code, T: Tape & 7" Reel Packing; W: Tape & 13" Reel Packing

2. RoHS product for packing code suffix "G", Halogen free product for packing code suffix "H" .

*****Disclaimer*****

WILLAS reserves the right to make changes without notice to any product specification herein, to make corrections, modifications, enhancements or other changes. WILLAS or anyone on its behalf assumes no responsibility or liability for any errors or inaccuracies. Data sheet specifications and its information contained are intended to provide a product description only. "Typical" parameters which may be included on WILLAS data sheets and/ or specifications can and do vary in different applications and actual performance may vary over time. WILLAS does not assume any liability arising out of the application or use of any product or circuit.

WILLAS products are not designed, intended or authorized for use in medical, life-saving implant or other applications intended for life-sustaining or other related applications where a failure or malfunction of component or circuitry may directly or indirectly cause injury or threaten a life without expressed written approval of WILLAS. Customers using or selling WILLAS components for use in such applications do so at their own risk and shall agree to fully indemnify WILLAS Inc and its subsidiaries harmless against all claims, damages and expenditures.