

5.0 Amp Glass Passivated Super Fast Rectifiers - 50~600Volts

DO-201AD Package

Features

- Glass Passivated Chip
- Low Forward Voltage
- High Current Capability
- High reliability
- Super Fast Switching Speed
- High Surge Current Capability
- Moisture Sensitivity Level 1
- RoHS product for packing code suffix "G"
- Halogen free product for packing code suffix "H"

Mechanical Date

- Case: Molded Plastic, DO-201AD
- Epoxy: UL 94V-0 Rate Flame Retardant
- Lead: Solderable per MIL-STD-202, method 208 guaranteed
- Polarity: Color band denotes cathode end
- Mounting Position: Any
- Weight: 0.046 ounce, 1.18 gram (Approximate)



DO-201AD

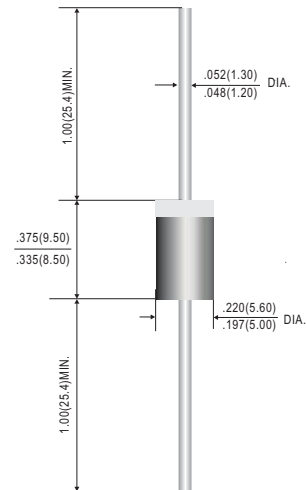

Dimensions in inches and (millimeters)

MAXIMUM RATINGS AND ELECTRICAL CHARACTERISTICS

Ratings at 25°C ambient temperature unless otherwise specified.

Single phase half wave, 60Hz, resistive or inductive load.

For capacitive load, derate current by 20%

RATINGS	SYMBOLS	SF51G	SF52G	SF53G	SF54G	SF55G	SF56G	SF58G	UNITS
Maximum Recurrent Peak Reverse Voltage	V_{RRM}	50	100	150	200	300	400	600	Volts
Maximum RMS Voltage	V_{RMS}	35	70	105	140	210	280	420	Volts
Maximum DC Blocking Voltage	V_{DC}	50	100	150	200	300	400	600	Volts
Maximum Average Forward rectifier Current 0.375" (9.5mm) Lead length at Ta = 55°C	$I_{F(AV)}$	5.0							Amps
Peak Forward Surge Current 8.3 ms single half sine-wave superimposed on rated load (JEDEC method)	I_{FSM}	150							Amps
Maximum Instantaneous Forward Voltage at 5.0A DC	V_F	0.95			1.27		1.75		Volts
Maximum DC Reverse Current at Rated DC Blocking Voltage	@ Ta=25°C	5.0							µA
	@ Ta=100°C	100							
Maximum Reverse Recovery Time (Note 1)	T_{RR}	35							ns
Typical Thermal Resistance (Note 3)	$R_{\theta JA}$	50							°C/W
	$R_{\theta JL}$	20							
Typical Junction Capacitance(Note 2)	C_J	50				30			pF
Operating and Storage Temperature Range	T_J, T_{STG}	-55 ~ 150							°C

Notes:

1. Test Conditions: $I_F = 0.5A$, $I_R = -1.0A$, $I_{RR} = -0.25A$
2. Measured at 1MHz and applied reverse voltage of 4.0VDC.
3. Typical Thermal Resistance: At 9.5mm lead lengths, PCB mounted.

RATING AND CHARACTERISTICS CURVES

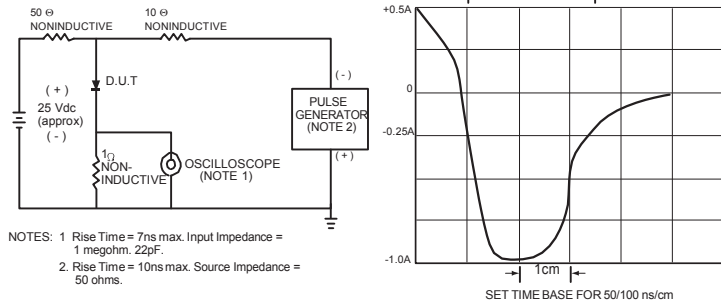

FIG.1 TEST CIRCUIT DIAGRAM AND REVERSE RECOVERY TIME CHARACTERISTIC

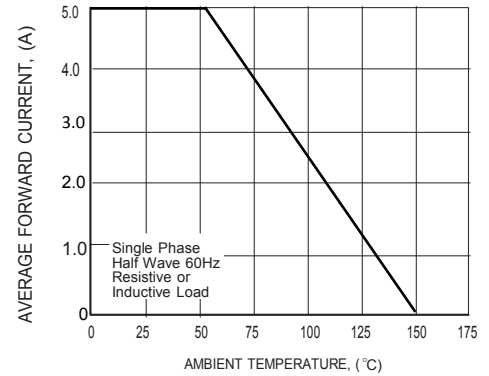

FIG.2 TYPICAL FORWARD CURRENT DERATING CURVE

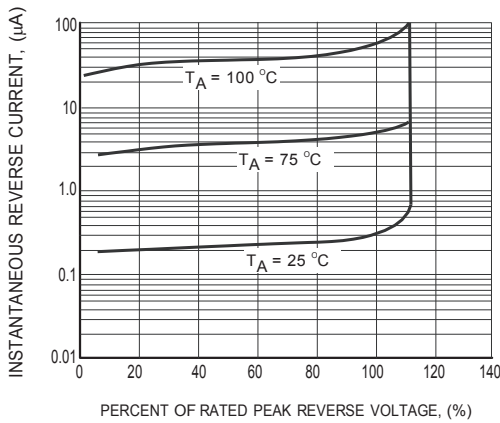

FIG.3 TYPICAL REVERSE CHARACTERISTICS

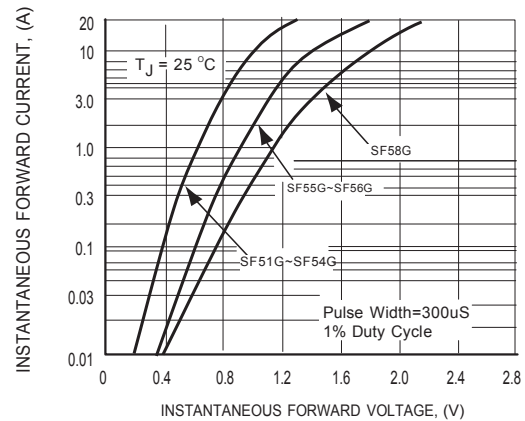

FIG.4 TYPICAL INSTANTANEOUS FORWARD CHARACTERISTICS

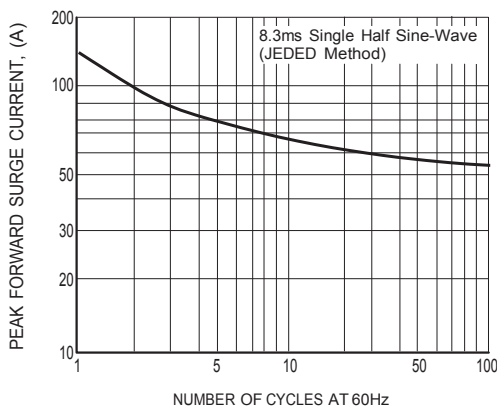

FIG.5 MAXIMUM NON-REPETITIVE FORWARD SURGE CURRENT

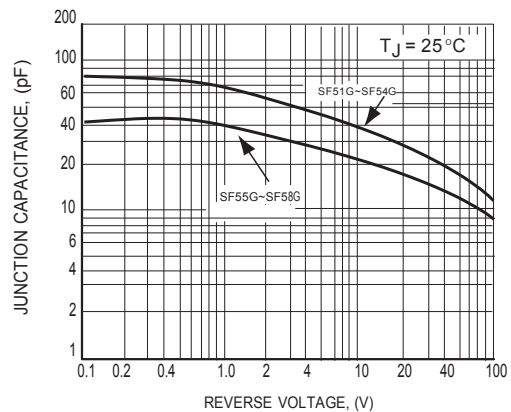

FIG.6 TYPICAL JUNCTION CAPACITANCE