



1.0A LOW VF SCHOTTKY BARRIER RECTIFIERS-20V-40V SOD-323-L PACKAGE

Features

- Batch process design, excellent power dissipation offers better reverse leakage current and thermal resistance.
- Low profile surface mounted application in order to optimize board space.
- Low power loss, high efficiency.
- High current capability, very low forward voltage drop.
- High surge capability.
- Guardring for overvoltage protection.
- Very tiny plastic SMD package.
- Ultra high-speed switching.
- Silicon epitaxial planar chip, metal silicon junction.
- **Moisture Sensitivity Level 1**

Mechanical data

- Epoxy : UL94-V0 rated flame retardant
- Case : Molded plastic, SOD-323-L
- Terminals :Plated terminals, solderable per MIL-STD-750, Method 2026
- Polarity : Indicated by cathode band
- Mounting Position : Any
- Weight : Approximated 0.008 gram

Package outline

SOD-323-L

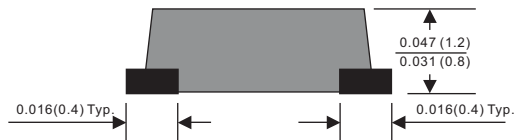
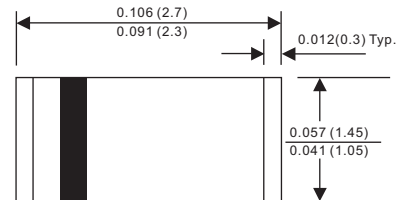

Dimensions in inches and (millimeters)

Maximum ratings and Electrical Characteristics (AT $T_A=25^{\circ}\text{C}$ unless otherwise noted)

PARAMETER	CONDITIONS	Symbol	MIN.	TYP.	MAX.	UNIT
Forward rectified current	See Fig.2	I_o			1.0	A
Forward surge current	8.3ms single half sine-wave superimposed on rate load (JEDEC methode)	I_{FSM}			30	A
Reverse current	$V_R = V_{RRM}$ $T_J = 25^{\circ}\text{C}$	I_R			1.0	mA
Thermal resistance	Junction to ambient	$R_{\theta JA}$		90		$^{\circ}\text{C}/\text{W}$
Diode junction capacitance	$f=1\text{MHz}$ and applied 4V DC reverse voltage	C_j		130		pF
Storage temperature		T_{STG}	-55		+150	$^{\circ}\text{C}$

SYMBOLS	V_{RRM}^{*1} (V)	V_{RMS}^{*2} (V)	V_R^{*3} (V)	V_F^{*4} (V)	Operating temperature T_J , ($^{\circ}\text{C}$)
SL12-N	20	14	20	0.38	-55 to +100
SL14-N	40	28	40	0.40	

*1 Repetitive peak reverse voltage

*2 RMS voltage

*3 Continuous reverse voltage

*4 Maximum forward voltage@ $I_F=1.0\text{A}$



Rating and characteristic curves (SL12-N THRU SL14-N)

FIG.1-TYPICAL FORWARD

CHARACTERISTICS

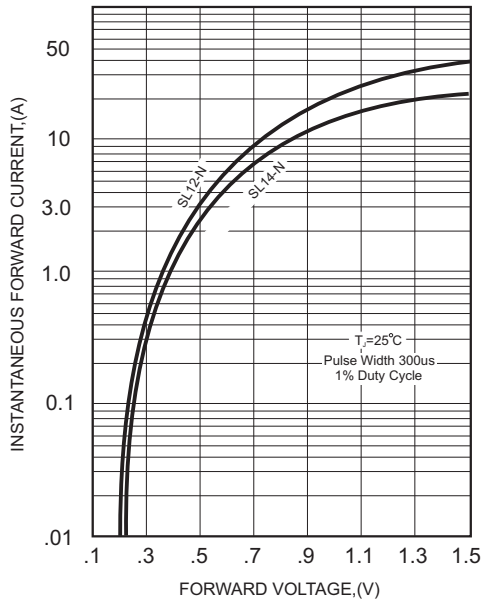

FIG.2-TYPICAL FORWARD CURRENT DERATING CURVE

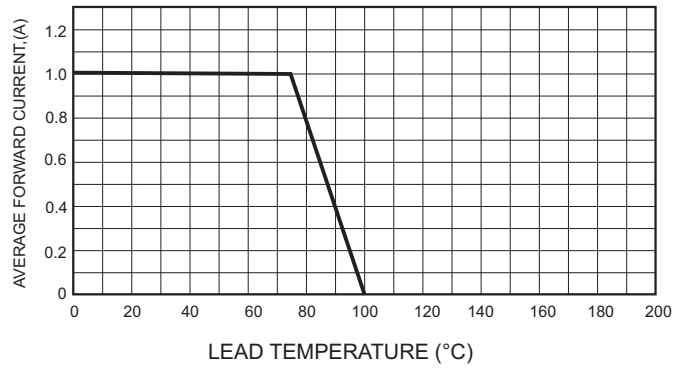

FIG.4-MAXIMUM NON-REPETITIVE FORWARD SURGE CURRENT

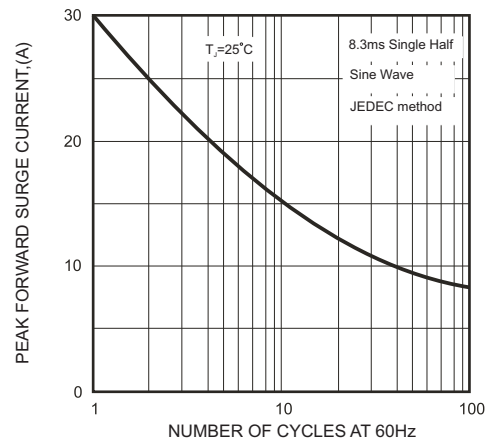

FIG.3 - TYPICAL REVERSE

CHARACTERISTICS

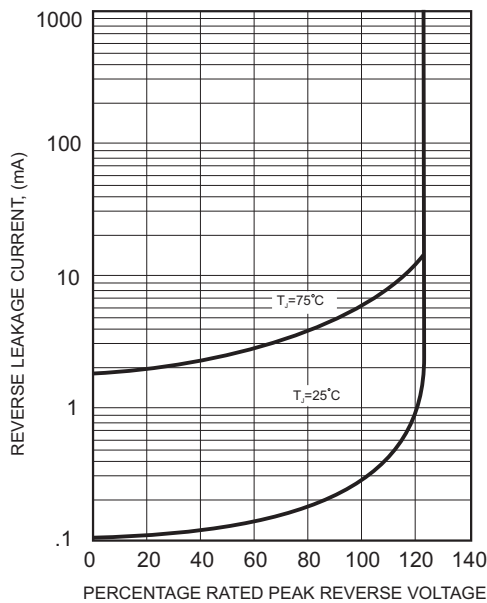
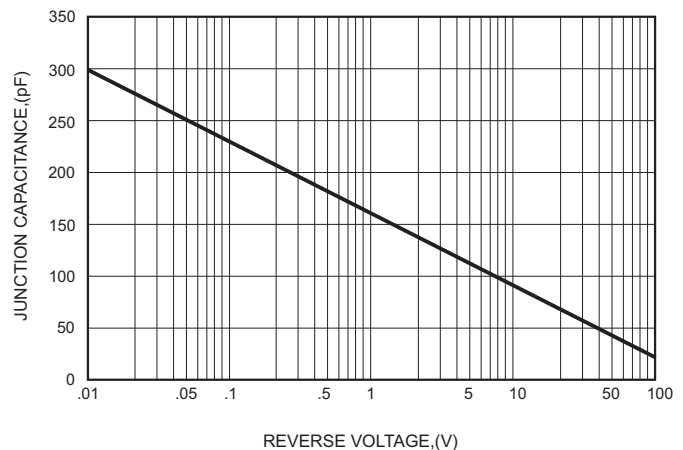

FIG.5-TYPICAL JUNCTION CAPACITANCE





Pinning information

Pin	Simplified outline	Symbol
Pin1 cathode Pin2 anode		

Reel packing

PACKAGE	REEL SIZE	REEL (pcs)	COMPONENT SPACING (m/m)	BOX (pcs)	INNER BOX (m/m)	REEL DIA. (m/m)	CARTON SIZE (m/m)	CARTON (pcs)	APPROX. GROSS WEIGHT (kg)
SOD-323-L	7"	3,000	4.0	30,000	183*183*123	178	382*262*387	240,000	8.0

Marking

Type number	Marking code
SL12-N-TH	L2
SL14-N-TH	L4

Note: N: Package code, SOD-323-L

-T: Taping Reel

Pb-Free package is available

RoHS product for packing code suffix "G"

Halogen free product for packing code suffix "H"

Suggested solder pad layout

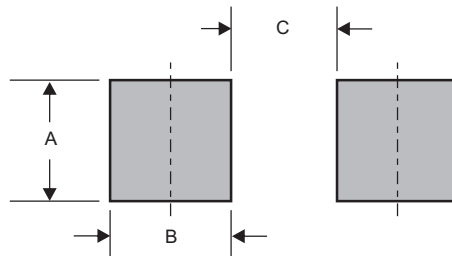

Dimensions in inches and (millimeters)

PACKAGE	A	B	C
SOD-323-L	0.059 (1.50)	0.039 (1.00)	0.051 (1.30)



Packing information

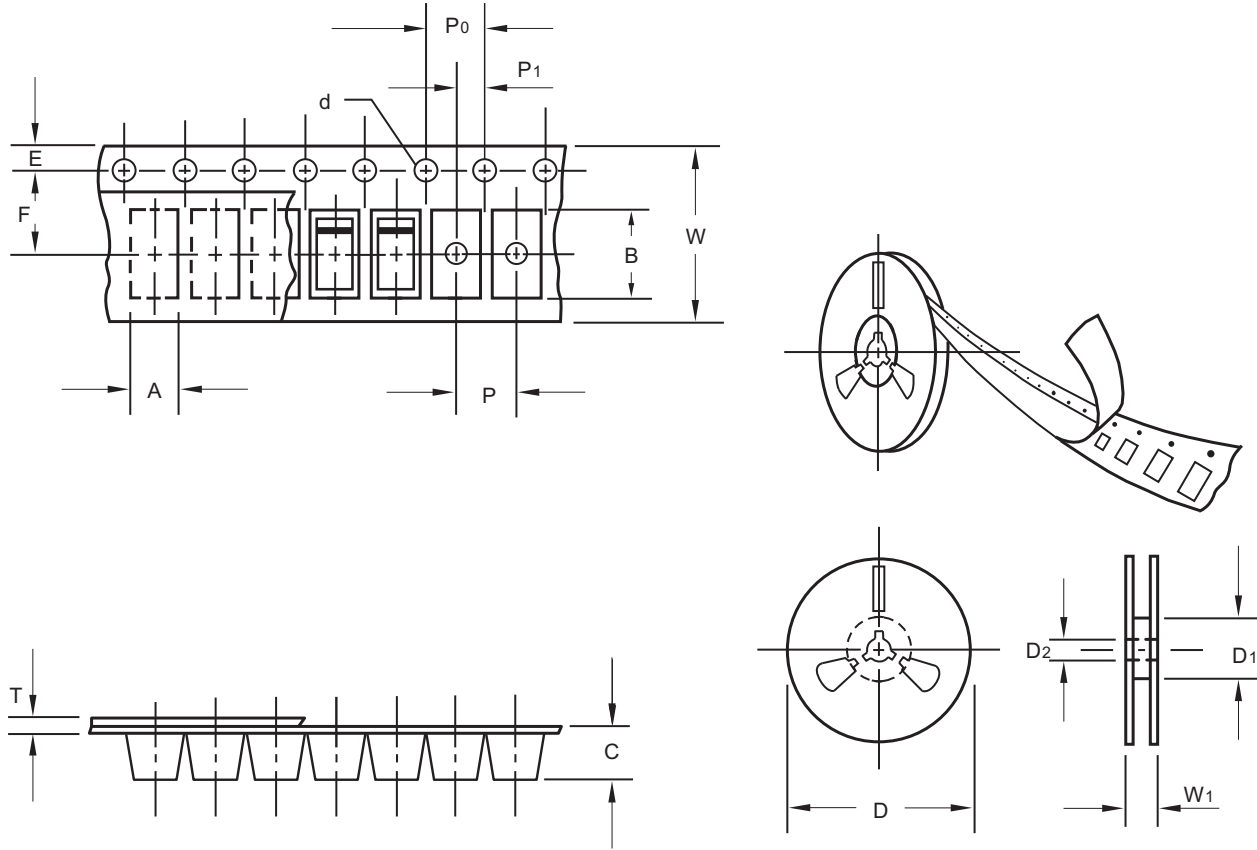

unit:mm

Item	Symbol	Tolerance	SOD-323-L
Carrier width	A	0.1	1.47
Carrier length	B	0.1	2.95
Carrier depth	C	0.1	1.15
Sprocket hole	d	0.1	1.50
13" Reel outside diameter	D	2.0	-
13" Reel inner diameter	D1	min	-
7" Reel outside diameter	D	2.0	178.00
7" Reel inner diameter	D1	min	62.00
Feed hole diameter	D2	0.5	13.00
Sprocket hole position	E	0.1	1.75
Punch hole position	F	0.1	3.50
Punch hole pitch	P	0.1	4.00
Sprocket hole pitch	P0	0.1	4.00
Embossment center	P1	0.1	2.00
Overall tape thickness	T	0.1	0.23
Tape width	W	0.3	8.00
Reel width	W1	1.0	11.40

Note: Devices are packed in accordance with EIA standard RS-481-A and specifications listed above.