

Silicon NPN Power Transistors

2SD1212

DESCRIPTION

- With TO-220 package
- Low collector saturation voltage
- Large current capacity.
- Complement to type 2SB903

APPLICATIONS

- Suitable for relay drivers, high-speed inverters, converters, and other general large current switching applications.
- High-speed switching applications

PINNING

PIN	DESCRIPTION
1	Base
2	Collector; connected to mounting base
3	Emitter

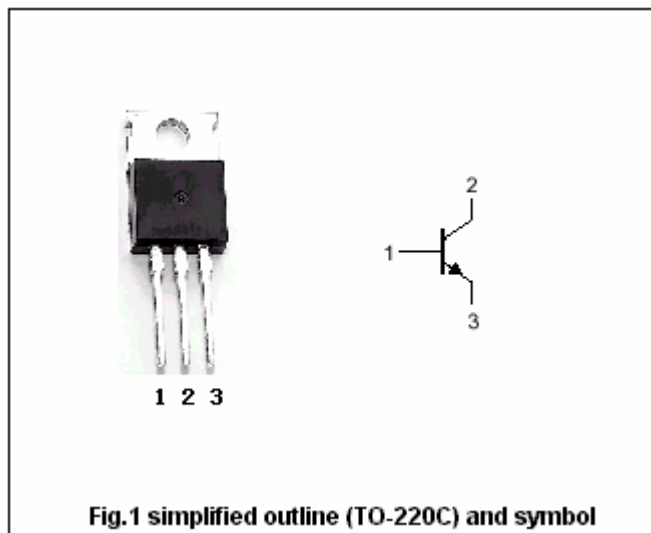

Absolute maximum ratings (Ta=25℃)

SYMBOL	PARAMETER	CONDITIONS	VALUE	UNIT
V _{CBO}	Collector-base voltage	Open emitter	60	V
V _{CEO}	Collector-emitter voltage	Open base	30	V
V _{EBO}	Emitter-base voltage	Open collector	6	V
I _C	Collector current		12	A
I _{CM}	Collector current-peak		20	A
P _C	Collector power dissipation		1.75	W
		T _C =25℃	35	
T _j	Junction temperature		150	℃
T _{stg}	Storage temperature		-55~150	℃

Silicon NPN Power Transistors

2SD1212

CHARACTERISTICS

T_j=25 °C unless otherwise specified

SYMBOL	PARAMETER	CONDITIONS	MIN	TYP	MAX	UNIT
V _{(BR)CBO}	Collector-base breakdown voltage	I _C =1mA ; I _E =0	60			V
V _{(BR)CEO}	Collector-emitter breakdown voltage	I _C =1mA ; R _{BE} =∞	30			V
V _{(BR)EBO}	Emitter-base breakdown voltage	I _E =1mA ; I _C =0	6			V
V _{CEsat}	Collector-emitter saturation voltage	I _C =5A, I _B =0.25A			0.4	V
I _{CBO}	Collector cut-offcurrent	V _{CB} =40V; I _E =0			0.1	mA
I _{EBO}	Emitter cut-offcurrent	V _{EB} =4V; I _C =0			0.1	mA
h _{FE-1}	DC current gain	I _C =1A ; V _{CE} =2V	70		280	
h _{FE-2}	DC current gain	I _C =6A ; V _{CE} =2V	30			
f _T	Transition frequency	I _C =1A ; V _{CE} =5V		120		MHz

Switching times

t _{on}	Turn-on time	I _C =5A ; I _{B1} =0.5A I _{B2} =-0.5A;		0.20		μs
t _{stg}	Storage time			0.50		μs
t _f	Fall time			0.03		μs

◆ h_{FE-1} classifications

Q	R	S
70-140	100-200	140-280

Silicon NPN Power Transistors

2SD1212

PACKAGE OUTLINE

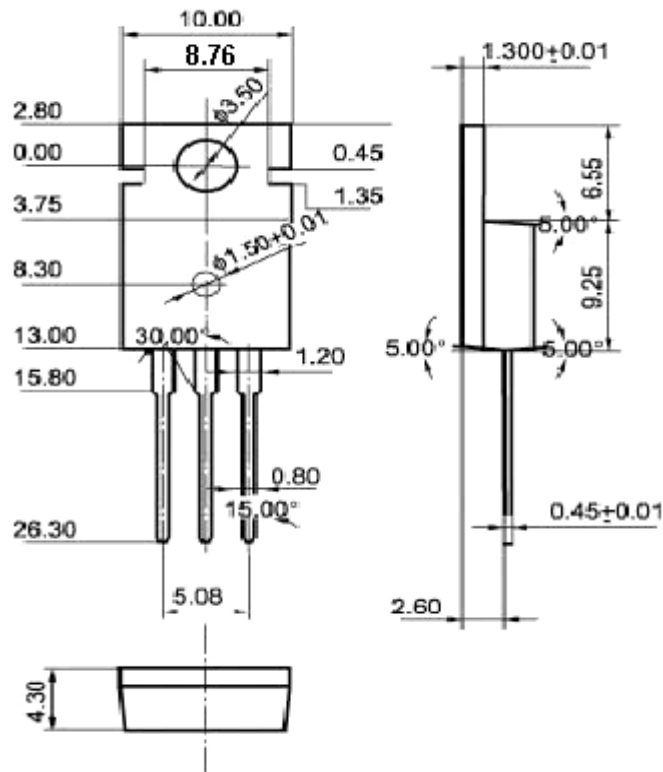

Fig.2 outline dimensions (unindicated tolerance:±0.10 mm)

Silicon NPN Power Transistors

2SD1212

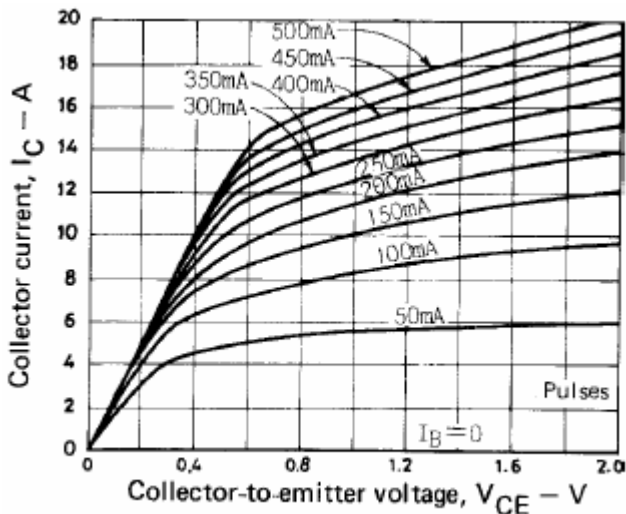

Fig.3 Static Characteristic

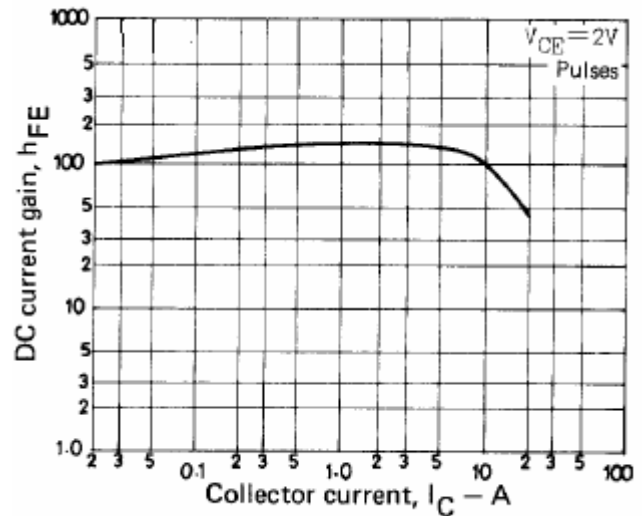

Fig.4 DC current Gain

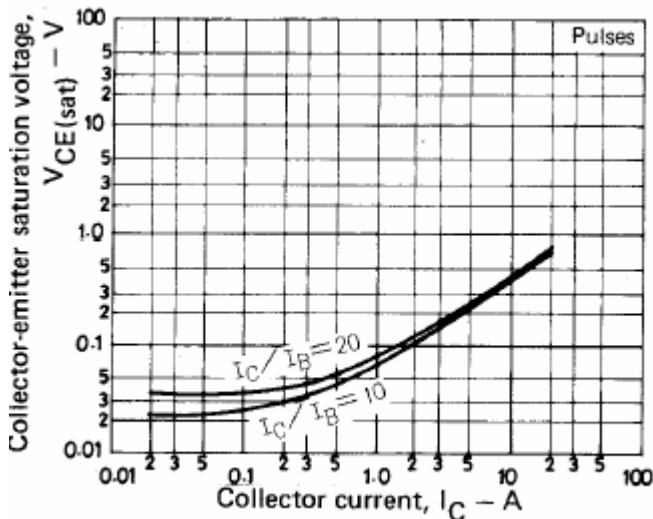

Fig.5 Collector-Emitter Saturation Voltage

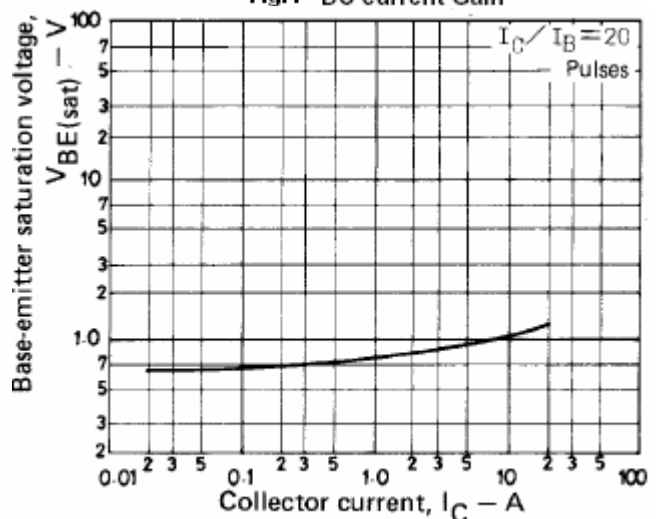

Fig.6 Base-Emitter Saturation Voltage

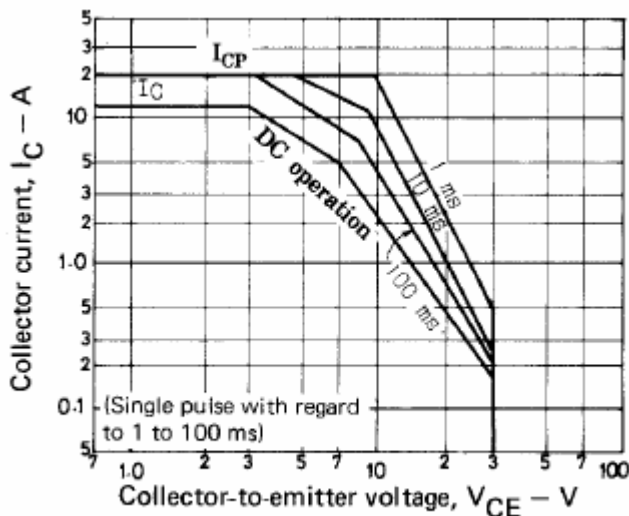

Fig.7 Safe Operating Area