

Silicon NPN Power Transistors

2SD401

DESCRIPTION

- With TO-220C package
- Complement to type 2SB546
- Collector current $I_C=2A$
- Collector-base voltage $V_{CBO}=200V$

APPLICATIONS

- For use in general purpose power amplifier, vertical output application

PINNING

PIN	DESCRIPTION
1	Base
2	Collector; connected to mounting base
3	Emitter

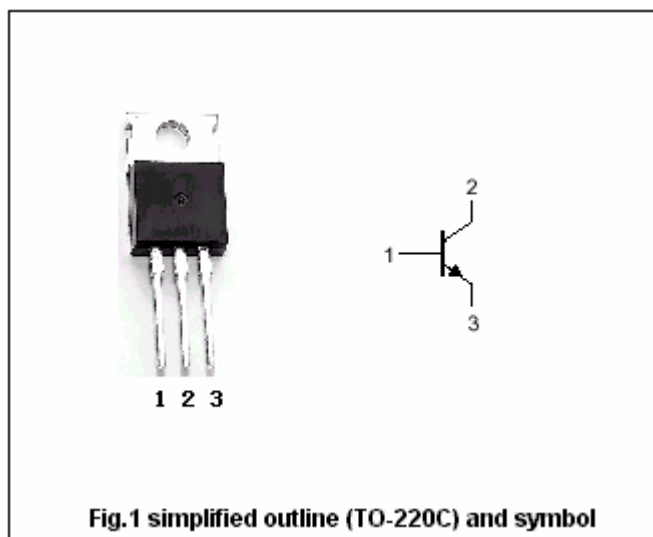
Absolute maximum ratings ($T_a=25^\circ C$)

SYMBOL	PARAMETER	CONDITIONS	VALUE	UNIT
V_{CBO}	Collector-base voltage	Open emitter	200	V
V_{CEO}	Collector-emitter voltage	Open base	150	V
V_{EBO}	Emitter-base voltage	Open collector	5	V
I_C	Collector current		2	A
P_C	Collector power dissipation	$T_C=25^\circ C$	25	W
T_j	Junction temperature		150	$^\circ C$
T_{stg}	Storage temperature		-55~150	$^\circ C$

Silicon NPN Power Transistors

2SD401

CHARACTERISTICS

T_j=25 °C unless otherwise specified

SYMBOL	PARAMETER	CONDITIONS	MIN	TYP.	MAX	UNIT
V _{(BR)CEO}	Collector-emitter breakdown voltage	I _C =10mA; I _B =0	150			V
V _{(BR)CBO}	Collector-base breakdown voltage	I _C =0.5mA; I _E =0	200			V
V _{(BR)EBO}	Emitter-base breakdown voltage	I _E =0.5mA; I _B =0	5			V
V _{CEsat}	Collector-emitter saturation voltage	I _C =500mA; I _B =50mA			1.0	V
I _{CBO}	Collector cut-off current	V _{CB} =150V; I _E =0			50	μA
I _{EBO}	Emitter cut-off current	V _{EB} =5V; I _C =0			50	μA
h _{FE}	DC current gain	I _C =0.4A; V _{CE} =10V	40		400	
f _T	Transition frequency	I _C =0.4A; V _{CE} =10V		5		MHz

◆ h_{FE} classifications

R	O	Y	G
40-80	70-140	120-240	200-400

Silicon NPN Power Transistors

2SD401

PACKAGE OUTLINE

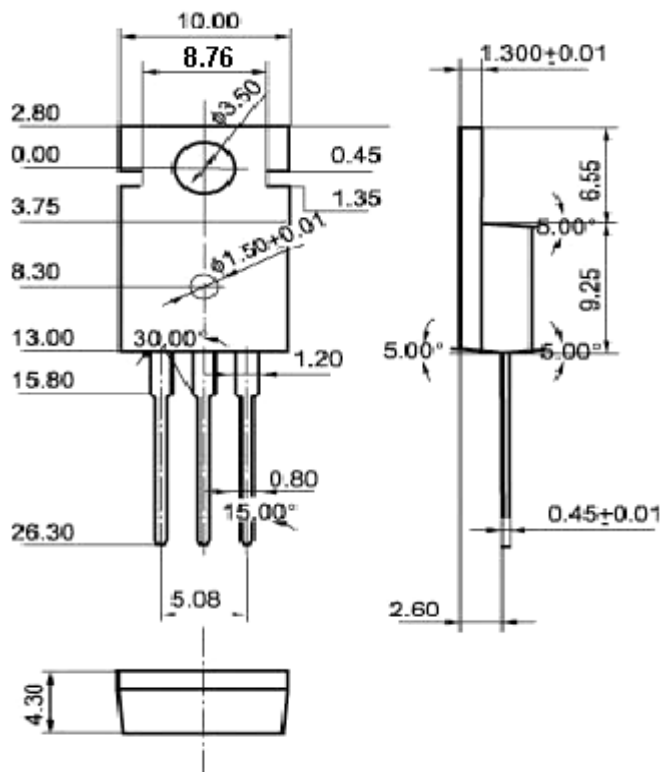

Fig.2 Outline dimensions (unindicated tolerance: ± 0.10 mm)

Silicon NPN Power Transistors

2SD401

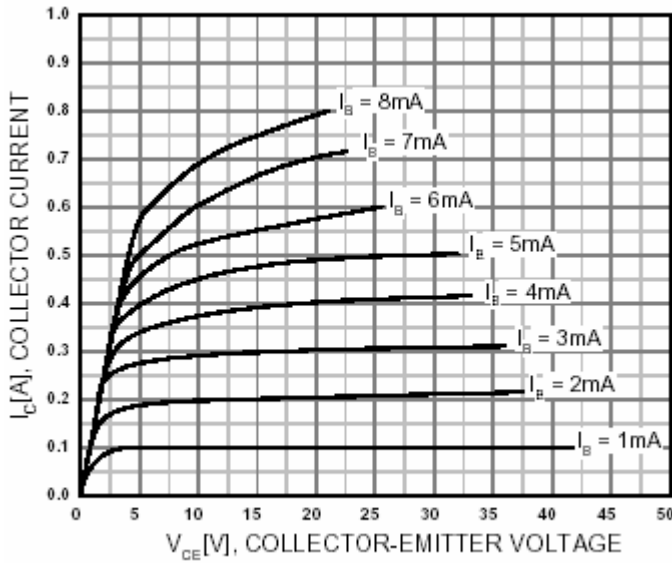

Fig.3 Static Characteristic

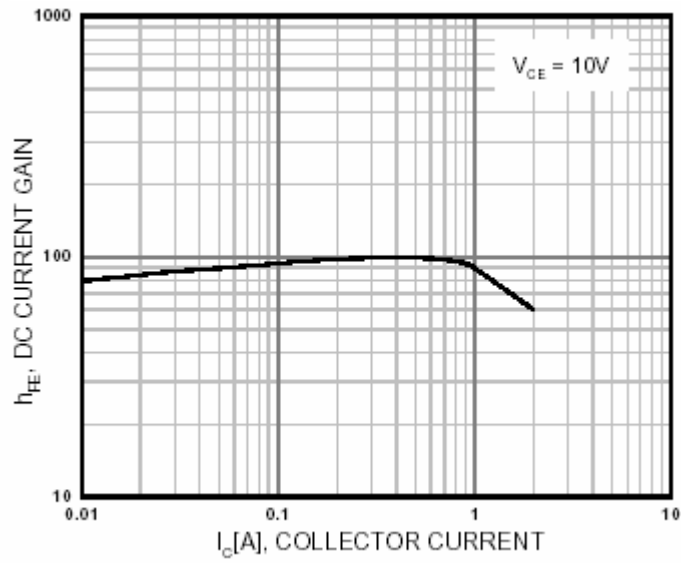

Fig.4 DC current Gain

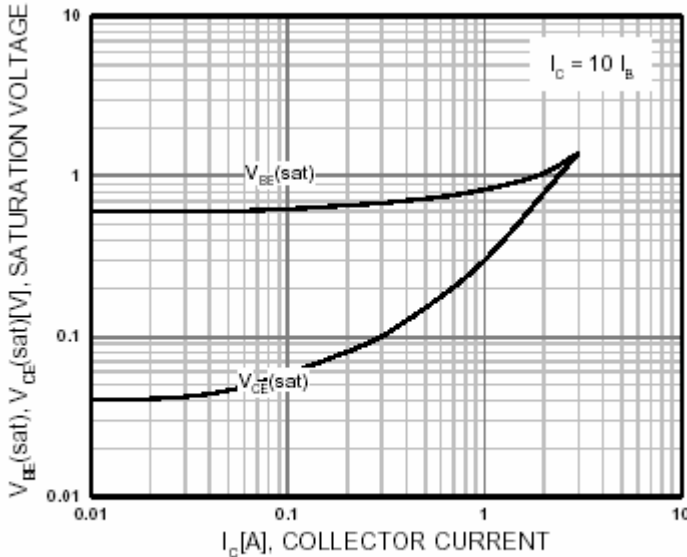

Fig.5 Base-Emitter Saturation Voltage
Collector-Emitter Saturation Voltage

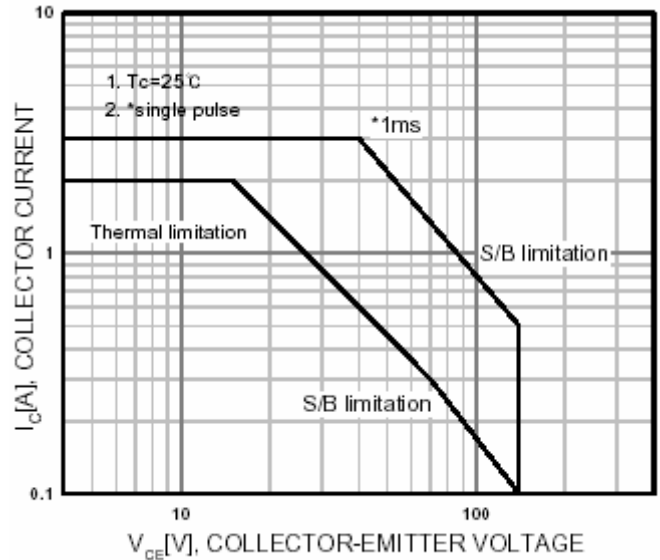

Fig.6 Safe Operating Area

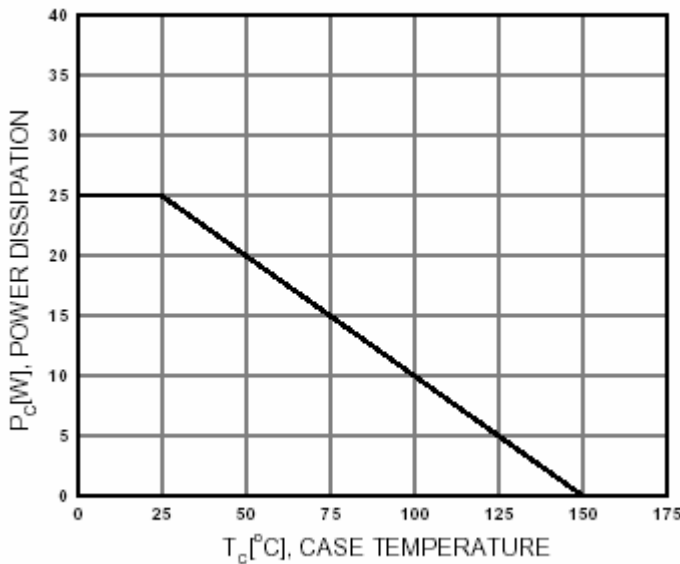

Fig.7 Power Derating