

Silicon NPN Power Transistors

2SC5250

DESCRIPTION

- With TO-3PFM package
- High breakdown voltage
- High speed switching
- Built-in damper diode

APPLICATIONS

- Character display horizontal deflection output applications

PINNING

PIN	DESCRIPTION
1	Base
2	Collector
3	Emitter

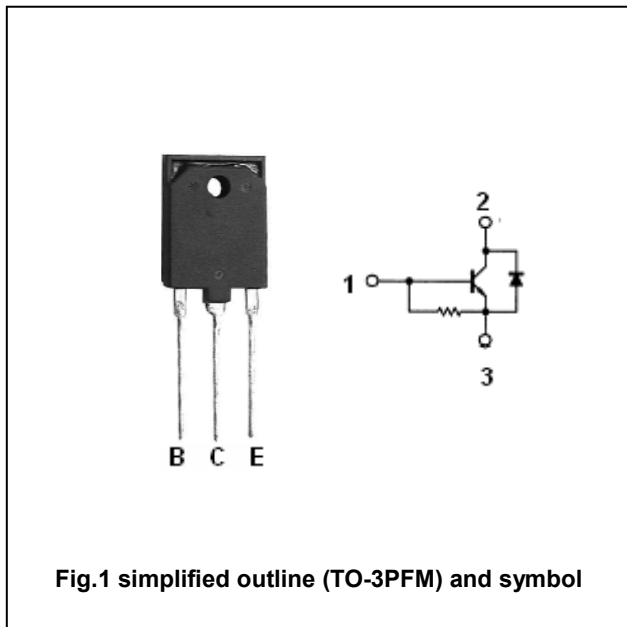

Fig.1 simplified outline (TO-3PFM) and symbol

Absolute maximum ratings(Ta=□)

SYMBOL	PARAMETER	CONDITIONS	VALUE	UNIT
V _{CEO}	Collector-emitter voltage	Open base	1500	V
V _{EBO}	Emitter-base voltage	Open collector	6	V
I _C	Collector current		8	A
I _{CP}	Collector current-peak		16	A
I _D	Diode current		8	A
P _C	Collector power dissipation	T _C =25□	50	W
T _j	Junction temperature		150	□
T _{stg}	Storage temperature		-55~150	□

Silicon NPN Power Transistors

2SC5250

CHARACTERISTICS

T_j=25°C unless otherwise specified

SYMBOL	PARAMETER	CONDITIONS	MIN	TYP.	MAX	UNIT
V _{(BR)EBO}	Emitter-base breakdown voltage	I _C =400mA ; I _B =0	6			V
I _{CES}	Collector cut-off current	V _{CE} =1500V; R _{BE} =0			500	μA
h _{FE-1}	DC current gain	I _C =1A ; V _{CE} =5V	6		25	
h _{FE-2}	DC current gain	I _C =5A ; V _{CE} =5V	4		7	
V _{CE(sat)}	Collector-emitter saturation voltage	I _C =5A ; I _B =1.25A			5	V
V _{BE(sat)}	Base-emitter saturation voltage	I _C =5A ; I _B =1.25A			1.5	V
V _{ECF}	Forward voltage of damper diode	I _F =8A			2	V
t _f	Fall time	I _{CP} =5A; I _{B1} =1A; f _H =31.5kHz		0.2	0.4	μs

Silicon NPN Power Transistors

2SC5250

PACKAGE OUTLINE

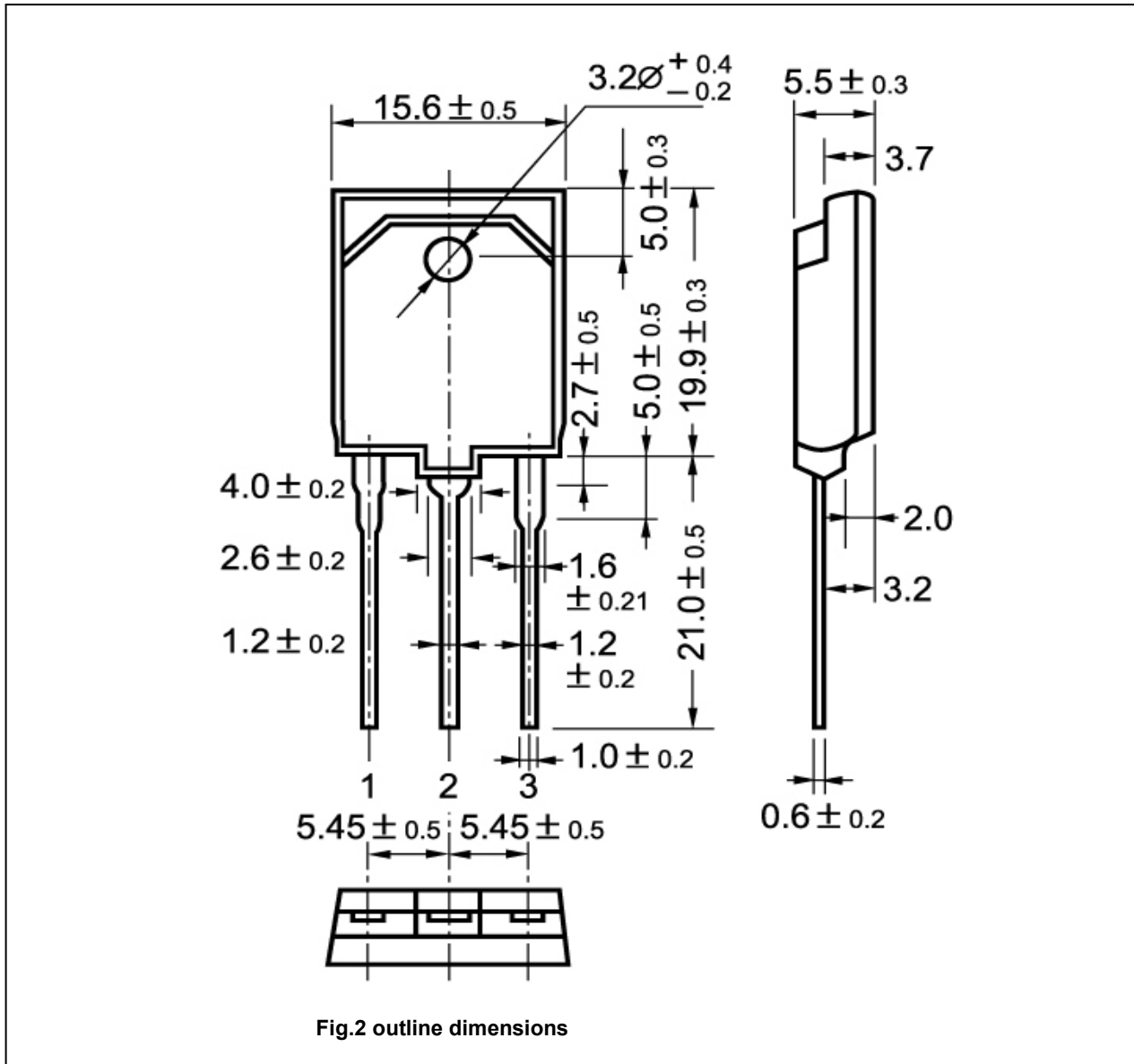

Fig.2 outline dimensions

Silicon NPN Power Transistors

2SC5250

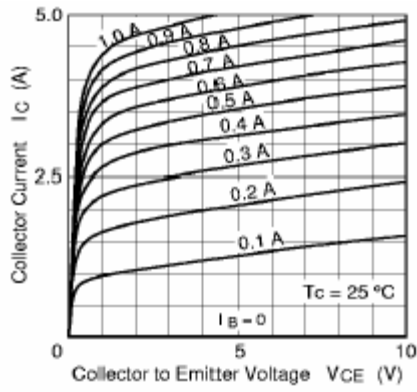

Fig.3 Static Characteristic

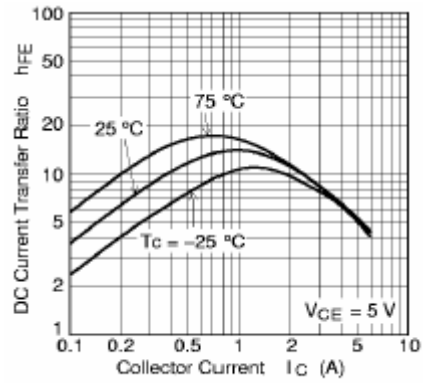

Fig.4 DC current Gain

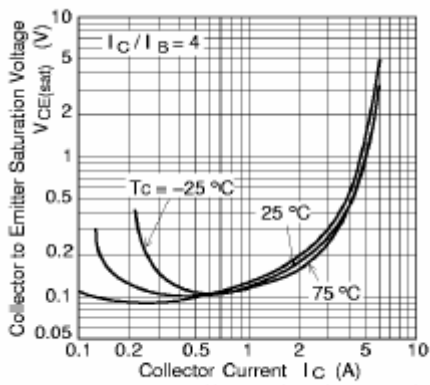

Fig.5 Collector-Emitter Saturation Voltage

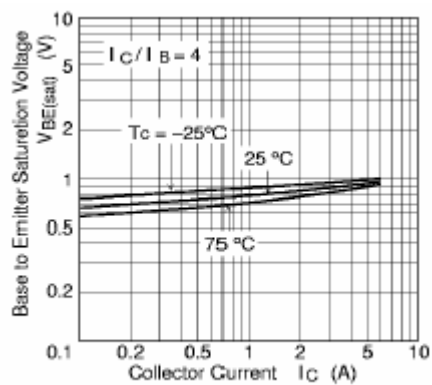

Fig.6 Base-Emitter Saturation Voltage

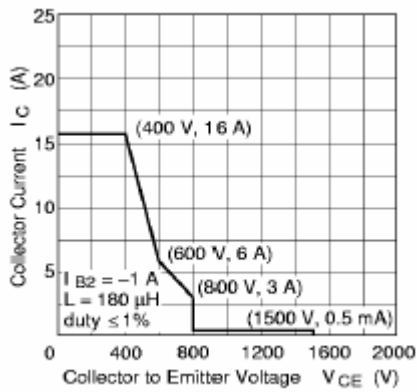

Fig.7 Safe Operating Area