

Silicon NPN Power Transistors

2SC4908

DESCRIPTION

- With TO-220F package
- High voltage.
- High speed switching

APPLICATIONS

- For switching regulator and general purpose applications

PINNING

PIN	DESCRIPTION
1	Base
2	Collector
3	Emitter

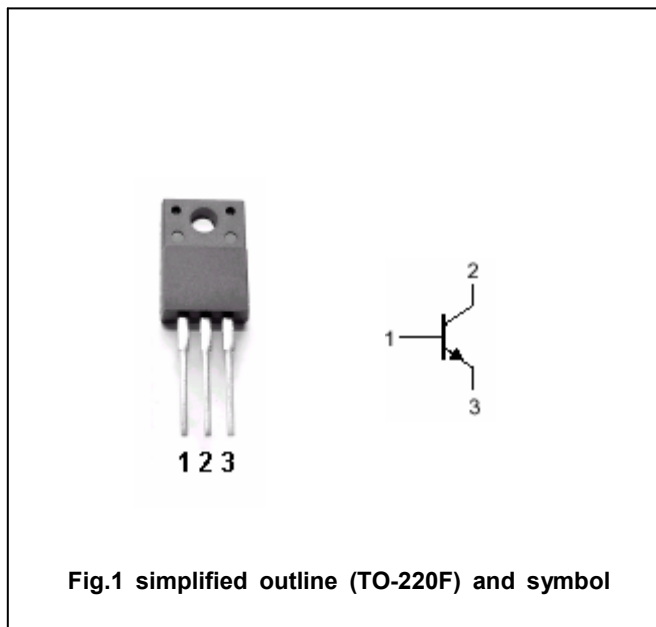

Absolute maximum ratings (Ta=25°C)

SYMBOL	PARAMETER	CONDITIONS	VALUE	UNIT
V _{CBO}	Collector-base voltage	Open emitter	900	V
V _{CEO}	Collector-emitter voltage	Open base	800	V
V _{EBO}	Emitter-base voltage	Open collector	7	V
I _C	Collector current		3	A
I _{CM}	Collector current-peak		6	A
I _B	Base current		1.5	A
P _C	Collector power dissipation	T _C =25°C	35	W
T _j	Junction temperature		150	°C
T _{stg}	Storage temperature		-55~150	°C

Silicon NPN Power Transistors

2SC4908

CHARACTERISTICS

Tj=25°C unless otherwise specified

SYMBOL	PARAMETER	CONDITIONS	MIN	TYP.	MAX	UNIT
$V_{(BR)CEO}$	Collector-emitter breakdown voltage	$I_C=10mA ; I_B=0$	800			V
V_{CEsat}	Collector-emitter saturation voltage	$I_C=0.7A ; I_B=0.14A$			0.5	V
V_{BEsat}	Base-emitter saturation voltage	$I_C=0.7A ; I_B=0.14A$			1.2	V
I_{CBO}	Collector cut-off current	$V_{CB}=800V ; I_E=0$			100	μA
I_{EBO}	Emitter cut-off current	$V_{EB}=7V ; I_C=0$			100	μA
h_{FE}	DC current gain	$I_C=0.7A ; V_{CE}=4V$	10		30	
C_{OB}	Output capacitance	$I_E=0 ; V_{CB}=10V ; f=1MHz$		40		pF
f_T	Transition frequency	$I_E=-0.3A ; V_{CE}=12V$		6		MHz

Switching times

t_{on}	Turn-on time	$I_C=0.7A ; I_{B1}=0.1A$ $I_{B2}=-0.35A$ $V_{CC}=250V , R_L=357\Omega$			1.0	μs
t_s	Storage time				5.0	μs
t_f	Fall time				1.0	μs

Silicon NPN Power Transistors

2SC4908

PACKAGE OUTLINE

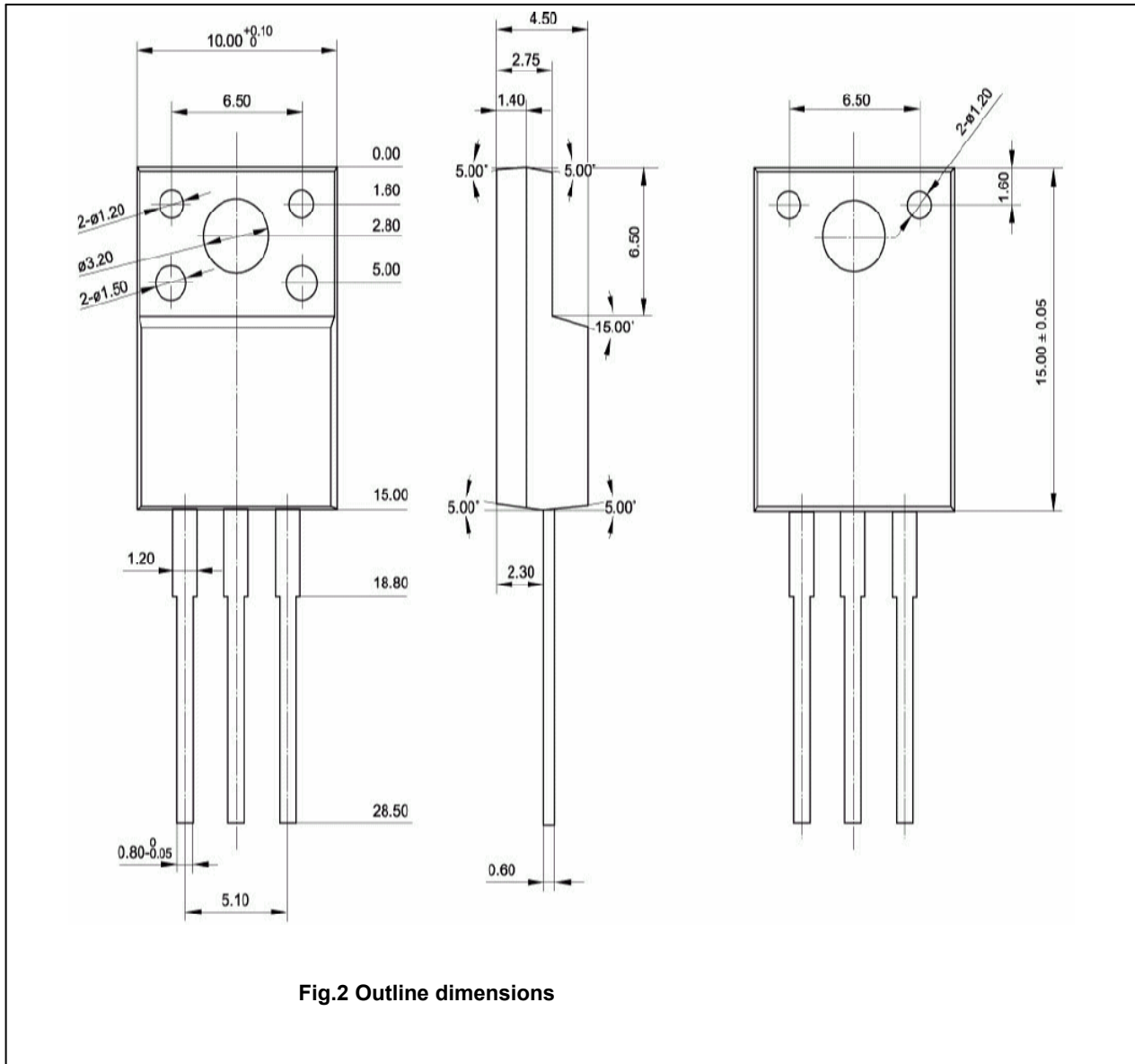

Fig.2 Outline dimensions

Silicon NPN Power Transistors

2SC4908

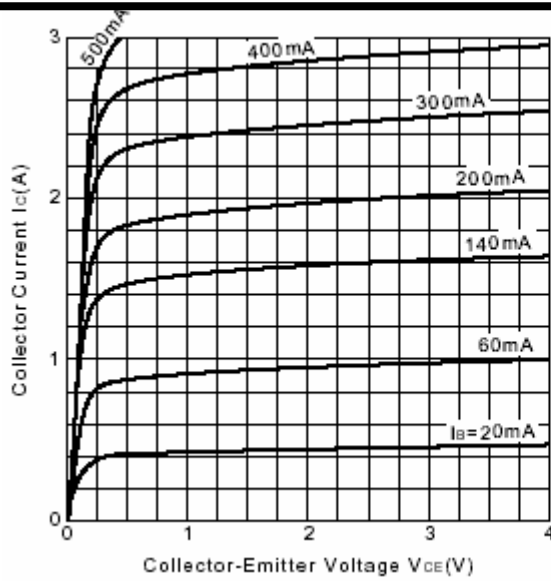

Fig.3 Static Characteristic

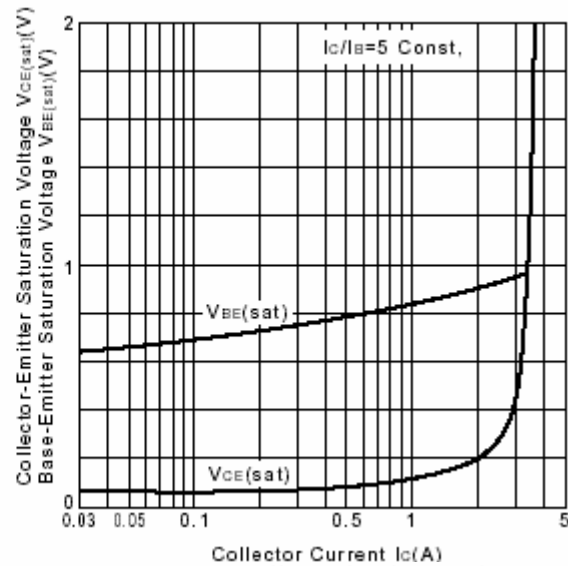

Fig.4 Base-Emitter Saturation Voltage
Collector-Emitter Saturation Voltage

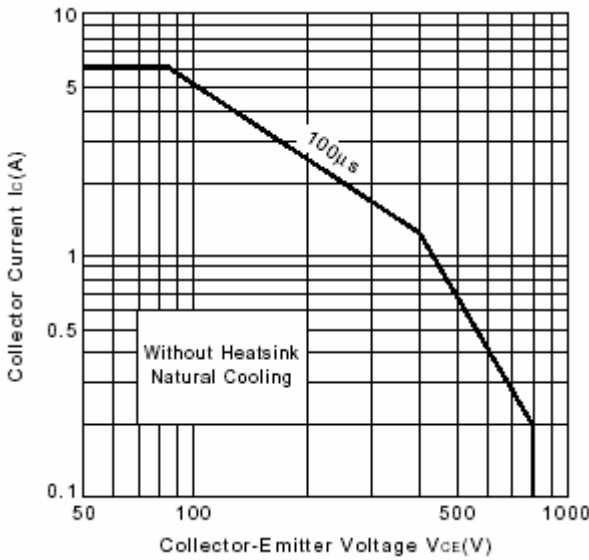

Fig.5 Safe Operating Area

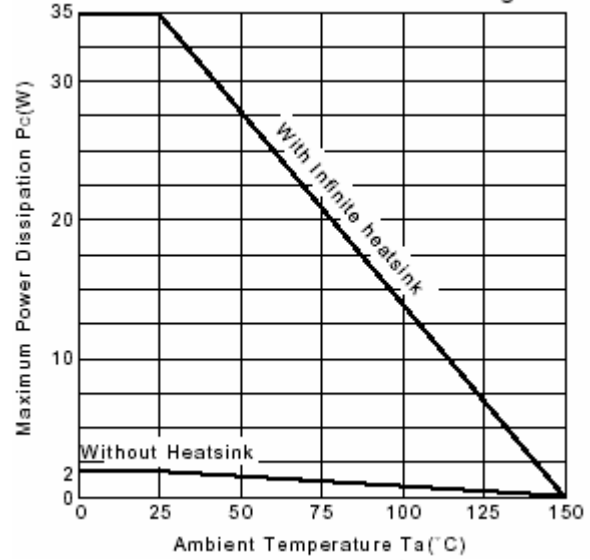

Fig.6 P_c - T_a Derating

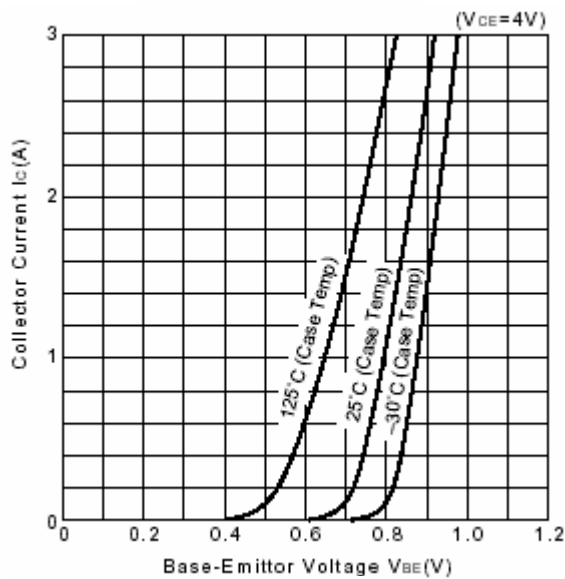

Fig.7 I_c - V_{BE}

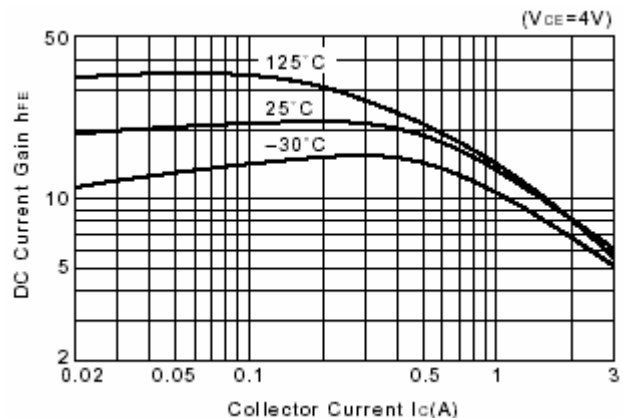

Fig.8 DC current Gain