

## Silicon NPN Power Transistors

2SC4164

## DESCRIPTION

- With TO-220C package
- High voltage ,high speed
- Wide area of safe operation

## APPLICATIONS

- For switching regulator applications

## PINNING

PIN	DESCRIPTION
1	Base
2	Collector; connected to mounting base
3	Emitter

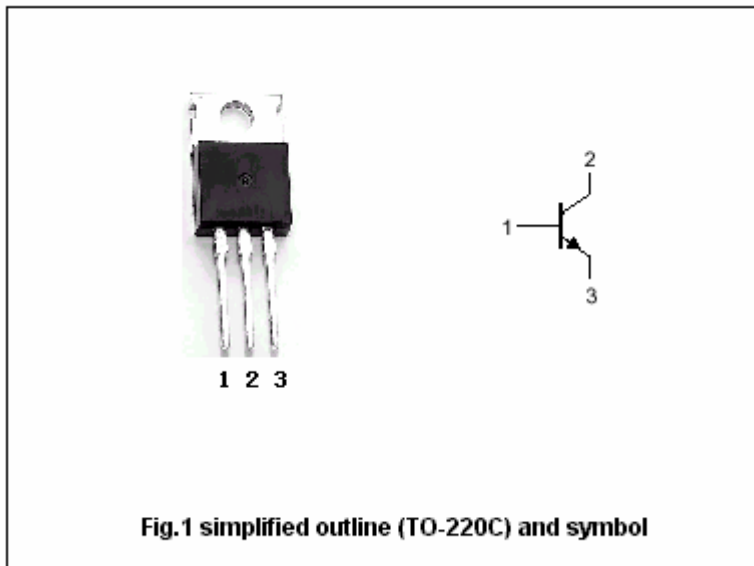
Absolute maximum ratings( $T_a=25^\circ\text{C}$ )

SYMBOL	PARAMETER	CONDITIONS	VALUE	UNIT
$V_{CBO}$	Collector-base voltage	Open emitter	500	V
$V_{CEO}$	Collector-emitter voltage	Open base	400	V
$V_{EBO}$	Emitter-base voltage	Open collector	7	V
$I_C$	Collector current		12	A
$I_{CM}$	Collector current-Peak	$P_w \leq 300\mu\text{s}$ , duty cycle $\leq 10\%$	25	A
$I_B$	Base current		4	A
$P_C$	Collector dissipation	$T_a=25^\circ\text{C}$	1.75	W
		$T_C=25^\circ\text{C}$	70	
$T_j$	Junction temperature		150	$^\circ\text{C}$
$T_{stg}$	Storage temperature		-50~150	$^\circ\text{C}$

## Silicon NPN Power Transistors

## 2SC4164

## CHARACTERISTICS

T<sub>j</sub>=25°C unless otherwise specified

SYMBOL	PARAMETER	CONDITIONS	MIN	TYP.	MAX	UNIT
V <sub>(BR)CEO</sub>	Collector-emitter breakdown voltage	I <sub>C</sub> =10mA ; R <sub>BE</sub> =∞	400			V
V <sub>(BR)CBO</sub>	Collector-base breakdown voltage	I <sub>C</sub> =1mA ; I <sub>E</sub> =0	500			V
V <sub>(BR)EBO</sub>	Emitter-base breakdown voltage	I <sub>E</sub> =1mA ; I <sub>C</sub> =0	7			V
V <sub>CEsat</sub>	Collector-emitter saturation voltage	I <sub>C</sub> =8A ; I <sub>B</sub> =1.6A			0.8	V
V <sub>BEsat</sub>	Base-emitter saturation voltage	I <sub>C</sub> =8A ; I <sub>B</sub> =1.6A			1.5	V
I <sub>CBO</sub>	Collector cut-off current	V <sub>CB</sub> =400V ; I <sub>E</sub> =0			10	μA
I <sub>EBO</sub>	Emitter cut-off current	V <sub>EB</sub> =5V ; I <sub>C</sub> =0			10	μA
h <sub>FE-1</sub>	DC current gain	I <sub>C</sub> =1.6A ; V <sub>CE</sub> =5V	15		50	
h <sub>FE-2</sub>	DC current gain	I <sub>C</sub> =8A ; V <sub>CE</sub> =5V	10			
h <sub>FE-3</sub>	DC current gain	I <sub>C</sub> =10mA ; V <sub>CE</sub> =5V	10			
f <sub>T</sub>	Transition frequency	I <sub>C</sub> =1.6A ; V <sub>CE</sub> =10V		20		MHz
C <sub>ob</sub>	Collector output capacitance	f=1MHz ; V <sub>CB</sub> =10V		160		pF

## Switching times

t <sub>on</sub>	Turn-on time	I <sub>C</sub> =10A ; I <sub>B1</sub> =2A I <sub>B2</sub> =-4A ; V <sub>CC</sub> =200V R <sub>L</sub> =20Ω			0.5	μs
t <sub>s</sub>	Storage time				2.5	μs
t <sub>f</sub>	Fall time				0.3	μs

◆ h<sub>FE-1</sub> Classifications

L	M	N
15-30	20-40	30-50

Silicon NPN Power Transistors

2SC4164

PACKAGE OUTLINE

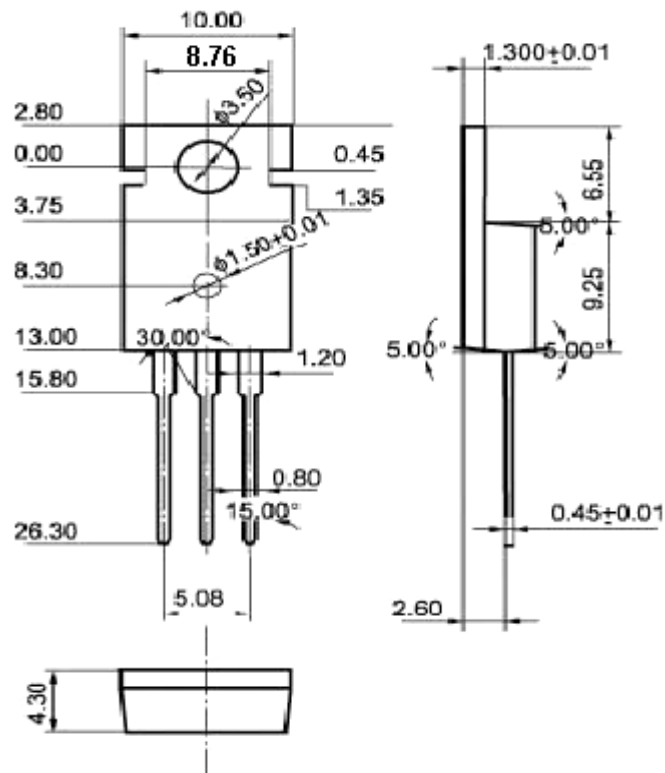

Fig.2 Outline dimensions (unindicated tolerance:±0.10 mm)

Silicon NPN Power Transistors

2SC4164

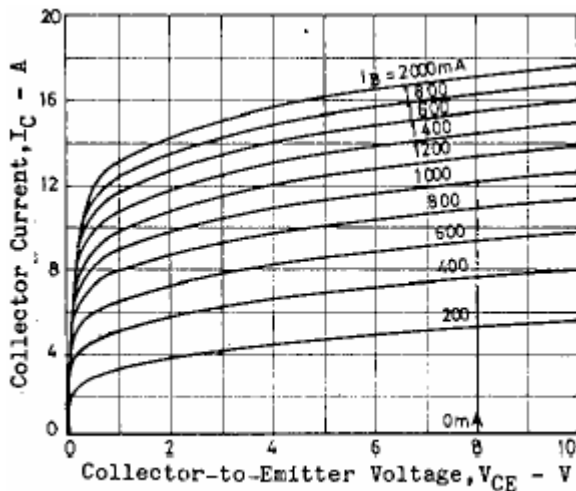

Fig.3 Static Characteristic

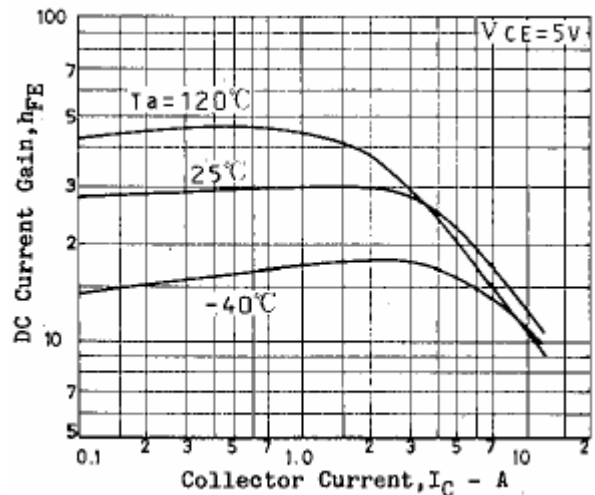

Fig.4 DC current Gain

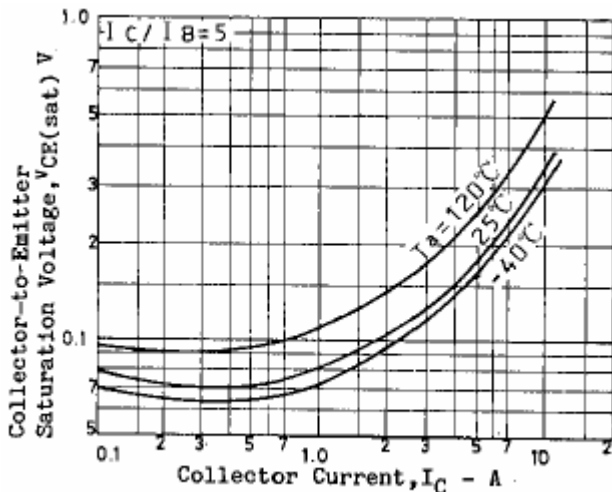

Fig.5 Collector-Emitter Saturation Voltage

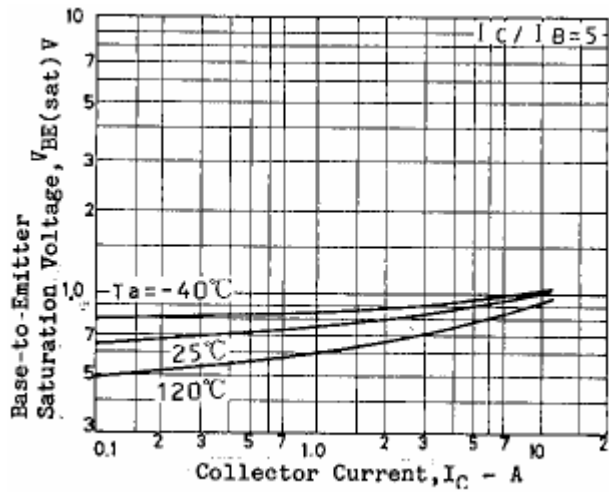

Fig.6 Base-Emitter Saturation Voltage

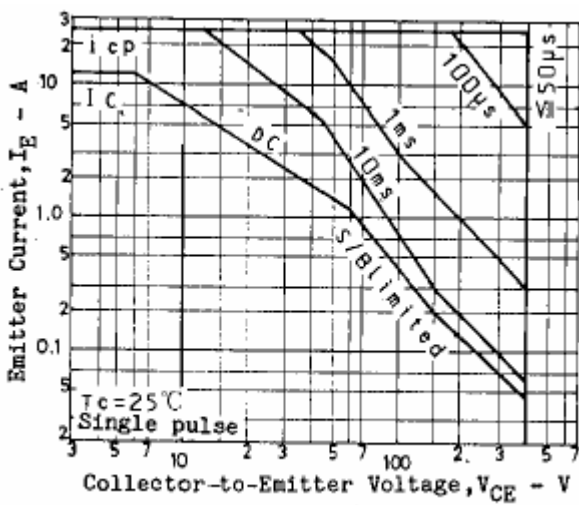

Fig.7 Safe Operating Area