

Silicon NPN Power Transistors

2SC4139

DESCRIPTION

- With TO-3PN package
- High voltage
- High speed switching

APPLICATIONS

- For switching regulator and general purpose applications

PINNING

PIN	DESCRIPTION
1	Base
2	Collector;connected to mounting base
3	Emitter

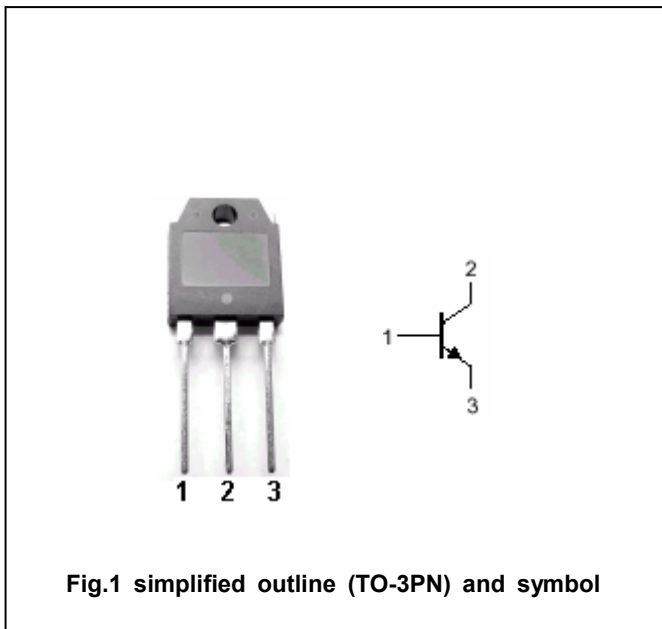

Fig.1 simplified outline (TO-3PN) and symbol

Absolute maximum ratings(Ta=□)

SYMBOL	PARAMETER	CONDITIONS	VALUE	UNIT
V _{CB0}	Collector-base voltage	Open emitter	500	V
V _{CEO}	Collector-emitter voltage	Open base	400	V
V _{EBO}	Emitter-base voltage	Open collector	10	V
I _C	Collector current		15	A
I _{CP}	Collector current-pulse		30	A
I _B	Base current		5	A
P _C	Collector power dissipation	T _C =25□	120	W
T _j	Junction temperature		150	□
T _{stg}	Storage temperature		-55~150	□

Silicon NPN Power Transistors

2SC4139

CHARACTERISTICS

T_j=25°C unless otherwise specified

SYMBOL	PARAMETER	CONDITIONS	MIN	TYP.	MAX	UNIT
V _{(BR)CEO}	Collector-emitter breakdown voltage	I _C =25mA ; I _B =0	400			V
V _{CEsat}	Collector-emitter saturation voltage	I _C =8A; I _B =1.6A			0.5	V
V _{BEsat}	Base-emitter saturation voltage	I _C =8A; I _B =1.6A			1.3	V
I _{CBO}	Collector cut-off current	V _{CB} =500V ; I _E =0			100	μA
I _{EBO}	Emitter cut-off current	V _{EB} =10V; I _C =0			100	μA
h _{FE}	DC current gain	I _C =8A ; V _{CE} =4V	10		30	
f _T	Transition frequency	I _E =-1.5A ; V _{CE} =12V		10		MHz
C _{OB}	Collector output capacitance	f=1MHz ; V _{CB} =10V		85		pF

Switching times

t _{on}	Turn-on time	I _C =8A; I _{B1} =0.8A; I _{B2} =-1.6A; R _L =25Ω V _{CC} =200V			1.0	μs
t _{stg}	Storage time				3.0	μs
t _f	Fall time				0.5	μs

Silicon NPN Power Transistors

2SC4139

PACKAGE OUTLINE

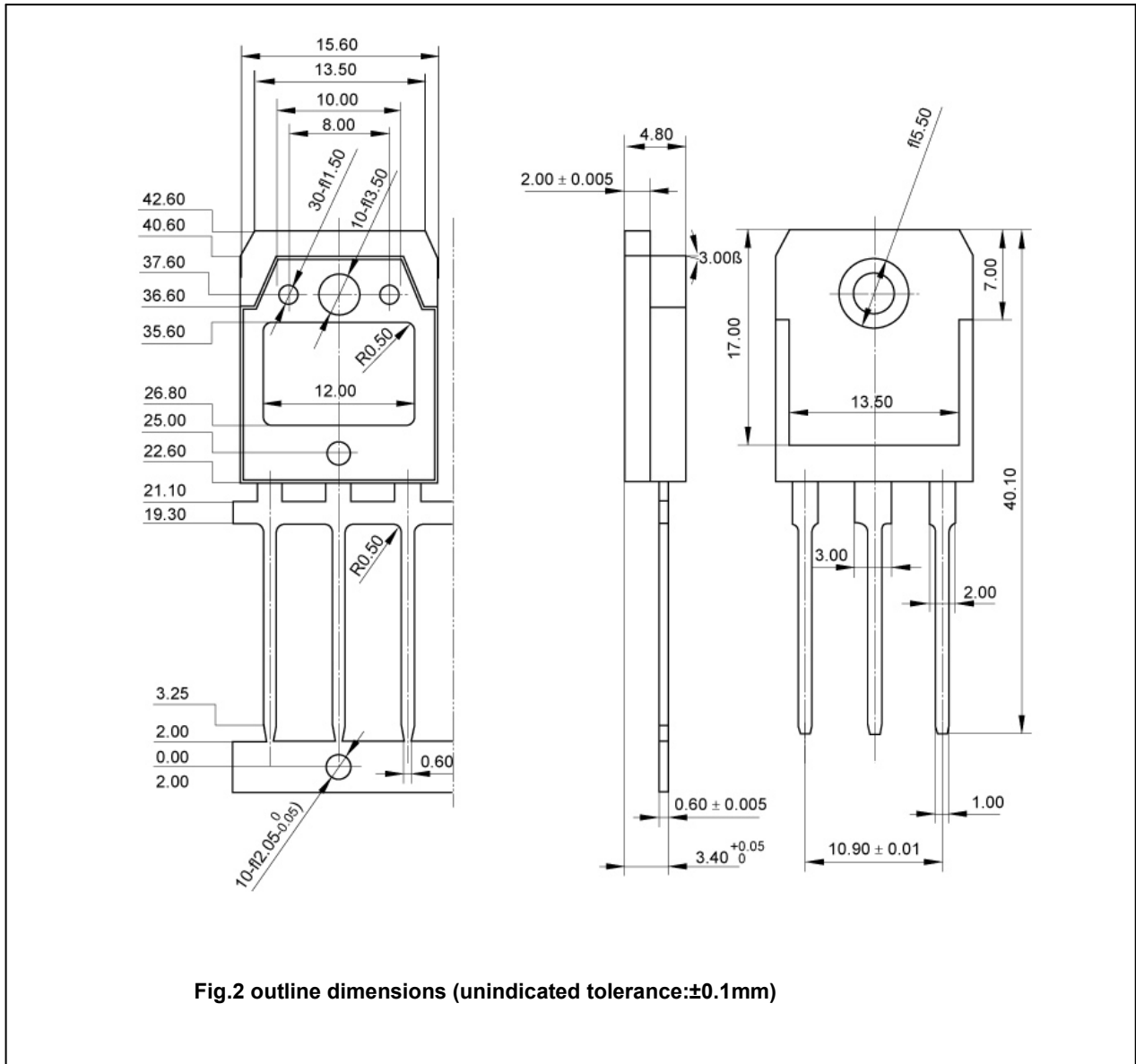

Fig.2 outline dimensions (unindicated tolerance: ± 0.1 mm)

Silicon NPN Power Transistors

2SC4139

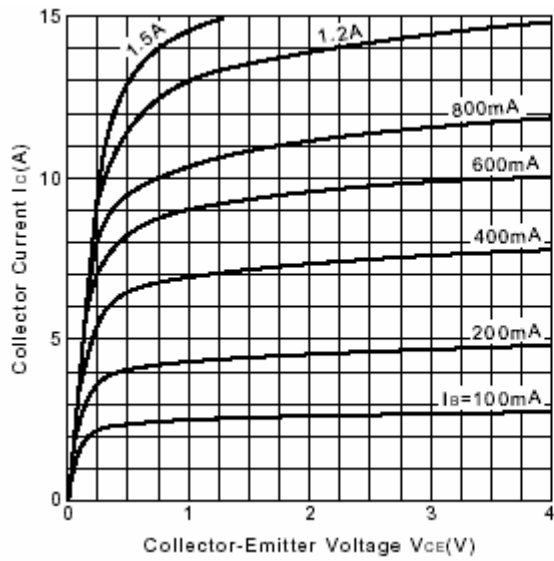

Fig.3 Static Characteristic

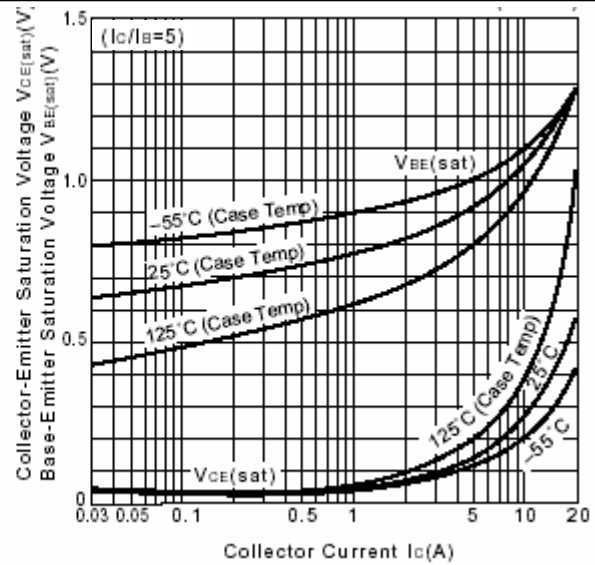

Fig.4 Base-Emitter Saturation Voltage
Collector-Emitter Saturation Voltage

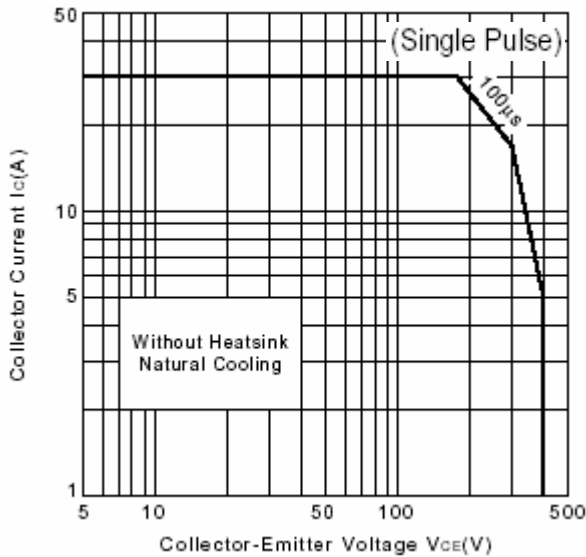

Fig.5 Safe Operating Area

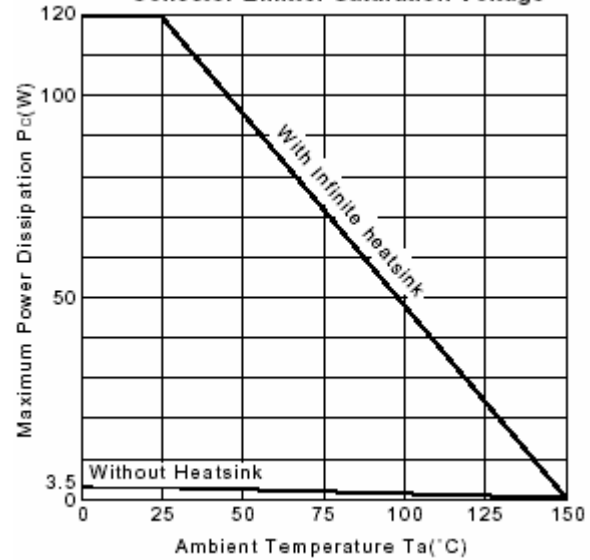

Fig.6 Pc-Ta Derating

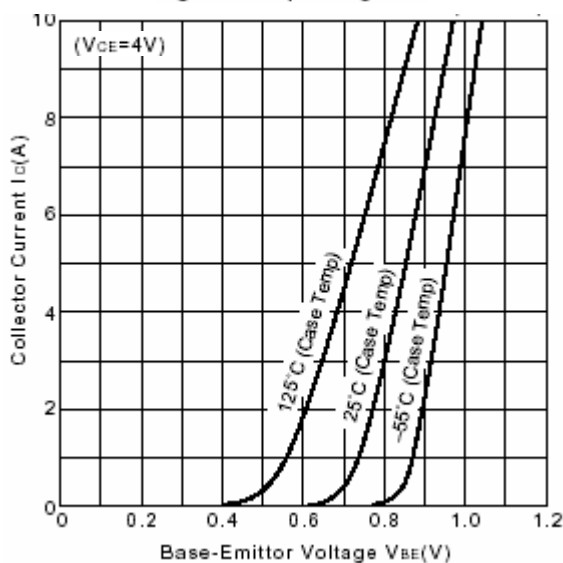

Fig.7 Ic-VBE

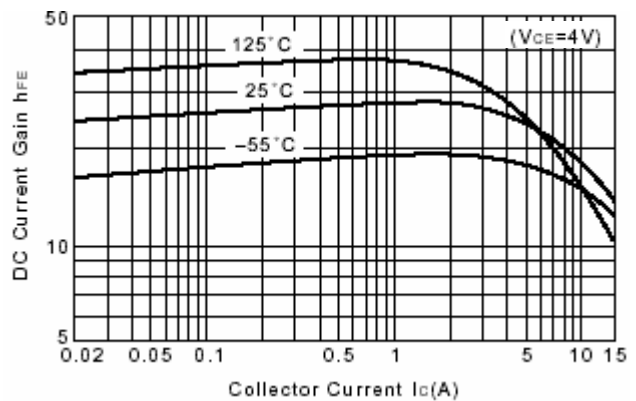

Fig.8 DC current Gain