

Silicon NPN Power Transistors

2SC3854

DESCRIPTION

- With TO-3PN package
- Complement to type 2SA1490

APPLICATIONS

- Audio and general purpose

PINNING

PIN	DESCRIPTION
1	Base
2	Collector;connected to mounting base
3	Emitter

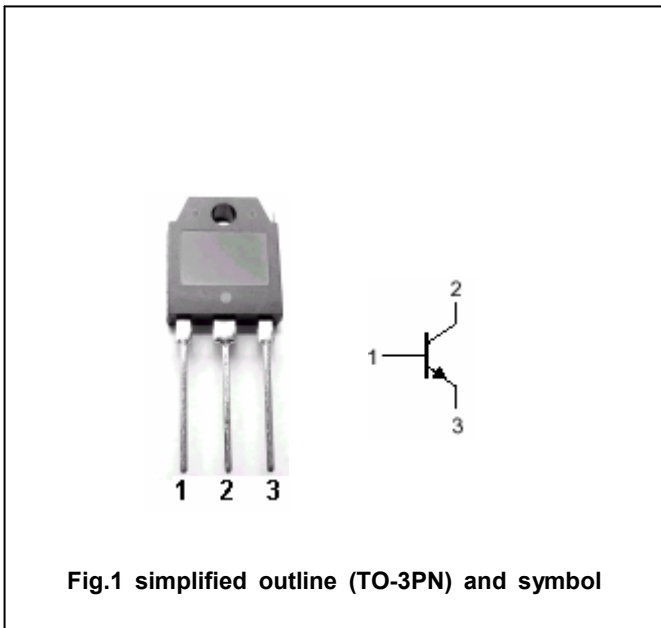

Fig.1 simplified outline (TO-3PN) and symbol

Absolute maximum ratings(Ta=□)

SYMBOL	PARAMETER	CONDITIONS	VALUE	UNIT
V _{CBO}	Collector-base voltage	Open emitter	160	V
V _{CEO}	Collector-emitter voltage	Open base	120	V
V _{EBO}	Emitter-base voltage	Open collector	6	V
I _C	Collector current		8	A
P _C	Collector power dissipation	T _C =25□	80	W
T _j	Junction temperature		150	□
T _{stg}	Storage temperature		-55~150	□

Silicon NPN Power Transistors

2SC3854

CHARACTERISTICS

T_j=25°C unless otherwise specified

SYMBOL	PARAMETER	CONDITIONS	MIN	TYP.	MAX	UNIT
V _{(BR)CEO}	Collector-emitter breakdown voltage	I _C =50mA ; I _B =0	120			V
V _{(BR)EBO}	Emitter-base breakdown voltage	I _E =1mA ; I _C =0	6			V
V _{CEsat}	Collector-emitter saturation voltage	I _C =3A ; I _B =0.3A			1.5	V
I _{CBO}	Collector cut-off current	V _{CB} =160V ; I _E =0			100	μA
I _{EBO}	Emitter cut-off current	V _{EB} =6V ; I _C =0			100	μA
h _{FE}	DC current gain	I _C =3A ; V _{CE} =4V	50			
f _T	Transition frequency	I _C =0.5A ; V _{CE} =12V		20		MHz

Silicon NPN Power Transistors

2SC3854

PACKAGE OUTLINE

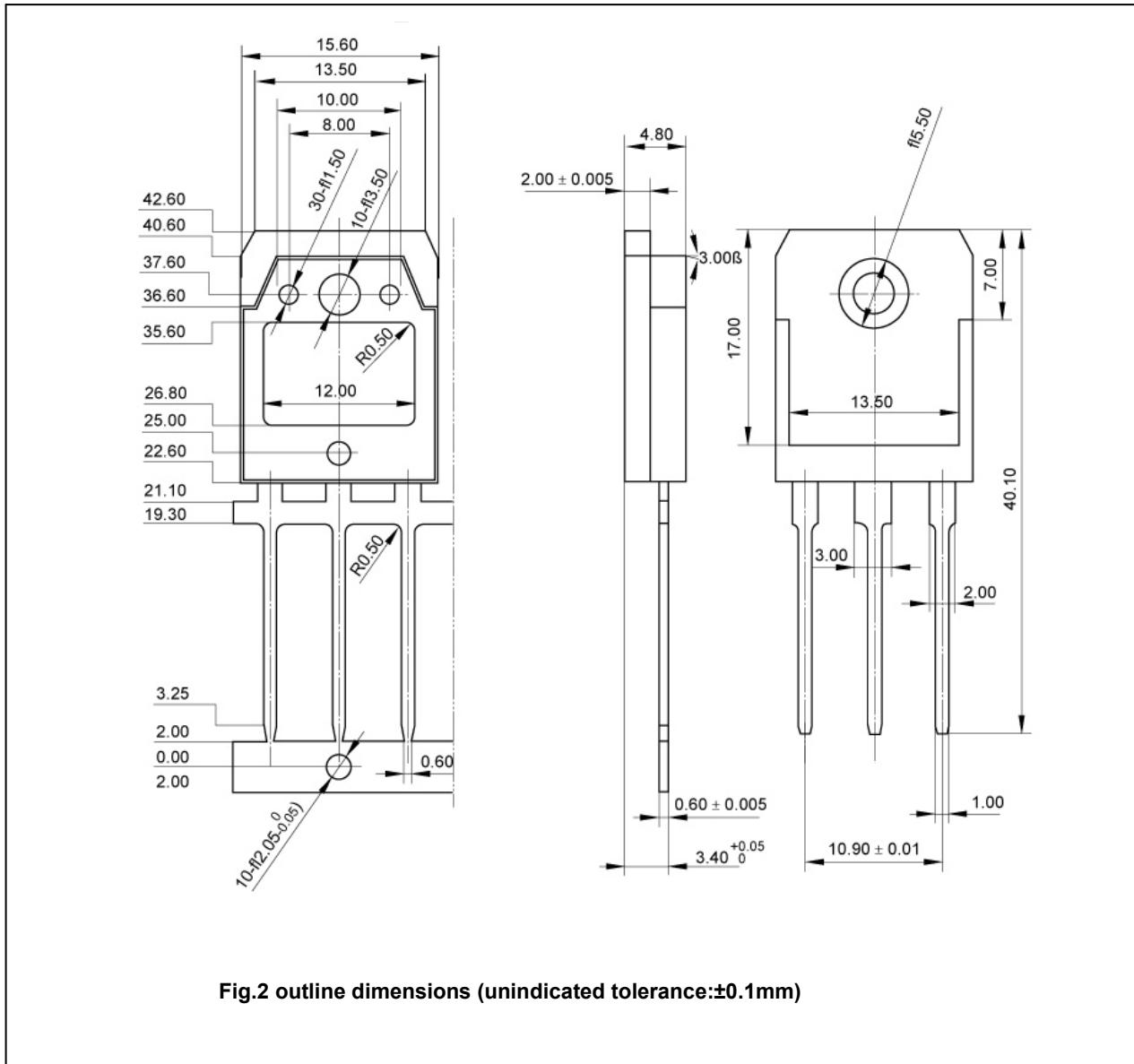

Fig.2 outline dimensions (unindicated tolerance:±0.1mm)