

Silicon NPN Power Transistors

2SC3309

DESCRIPTION

- With TO-220Fa package
- High collector breakdown voltage
- Excellent switching times

APPLICATIONS

- Switching regulators and high voltage switching applications
- High speed DC-DC converter application

PINNING

PIN	DESCRIPTION
1	Base
2	Collector
3	Emitter

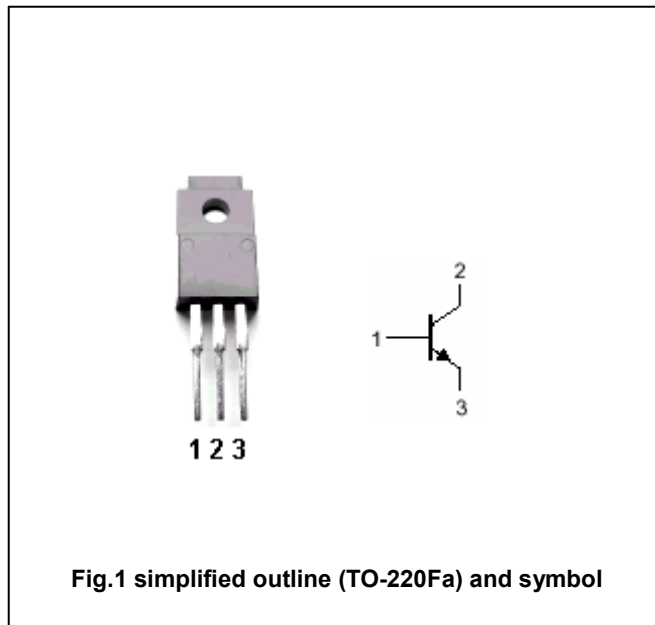

Absolute maximum ratings(Ta=25°C)

SYMBOL	PARAMETER	CONDITIONS	VALUE	UNIT
V _{CBO}	Collector-base voltage	Open emitter	500	V
V _{CEO}	Collector-emitter voltage	Open base	400	V
V _{EBO}	Emitter-base voltage	Open collector	7	V
I _C	Collector current (DC)		2	A
I _{CM}	Collector current-peak		4	A
I _B	Base current		0.5	A
P _C	Collector dissipation	T _a =25°C	2.0	W
		T _C =25°C	20	
T _j	Junction temperature		150	°C
T _{stg}	Storage temperature		-50~150	°C

Silicon NPN Power Transistors

2SC3309

CHARACTERISTICS

T_j=25 °C unless otherwise specified

SYMBOL	PARAMETER	CONDITIONS	MIN	TYP.	MAX	UNIT
V _{(BR)CEO}	Collector-emitter breakdown voltage	I _C =10mA ; I _B =0	400			V
V _{(BR)CBO}	Collector -base breakdown voltage	I _E =1mA; I _E =0	500			V
V _{CEsat}	Collector-emitter saturation voltage	I _C =1A; I _B =0.2A			1.0	V
V _{BEsat}	Base-emitter saturation voltage	I _C =1A; I _B =0.2A			1.5	V
I _{CBO}	Collector cut-off current	V _{CB} =400V; I _E =0			100	μA
I _{EBO}	Emitter cut-off current	V _{EB} =7V; I _C =0			1	mA
h _{FE-1}	DC current gain	I _C =0.1A ; V _{CE} =5V	20			
h _{FE-2}	DC current gain	I _C =1A ; V _{CE} =5V	8			

Switching times

t _r	Rise time	I _{B1} =-I _{B2} =0.08A V _{CC} ≈200V; R _L =250Ω PW=20μs			1.0	μs
t _s	Storage time				2.5	μs
t _f	Fall time				1.0	μs

PACKAGE OUTLINE

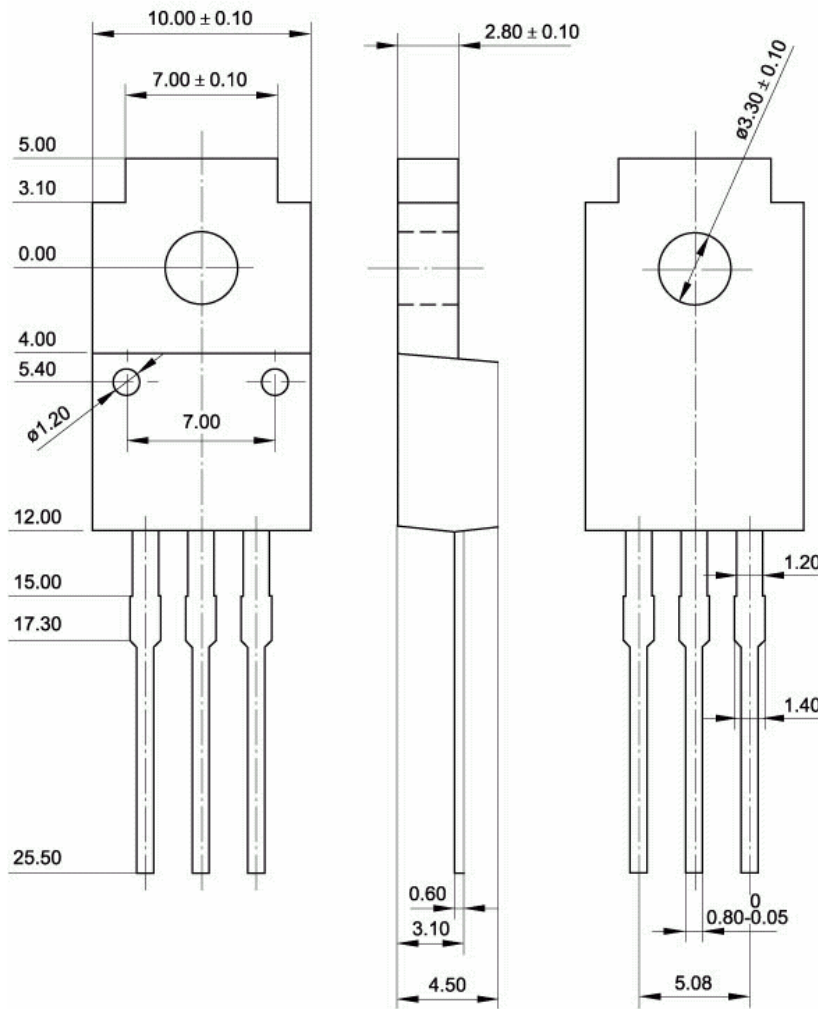

Fig.2 Outline dimensions (unindicated tolerance: ± 0.15 mm)

Silicon NPN Power Transistors

2SC3309

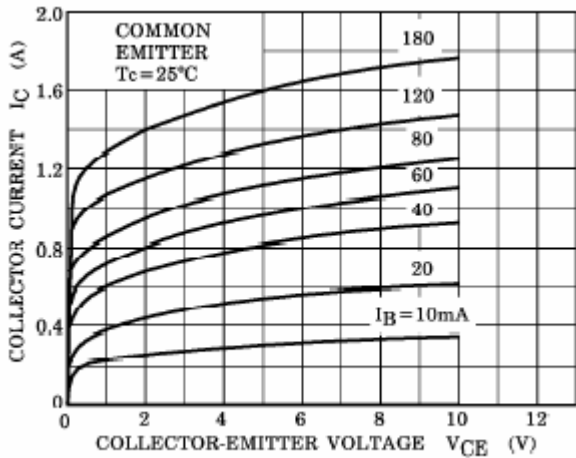

Fig.3 Static Characteristic

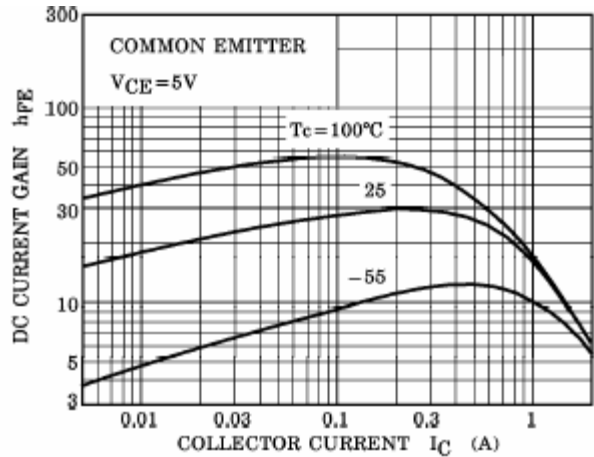

Fig.4 DC current Gain

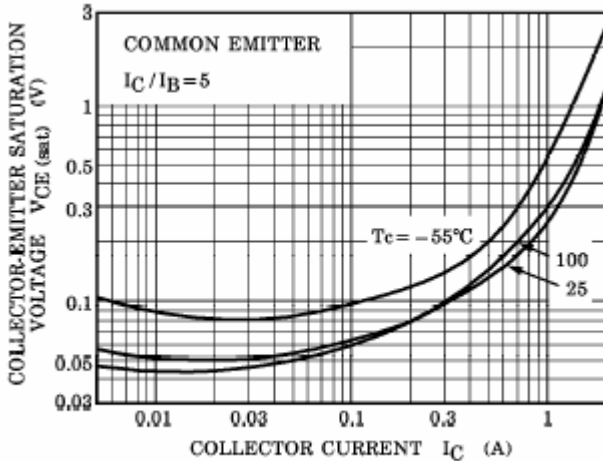

Fig.5 Collector-Emitter Saturation Voltage

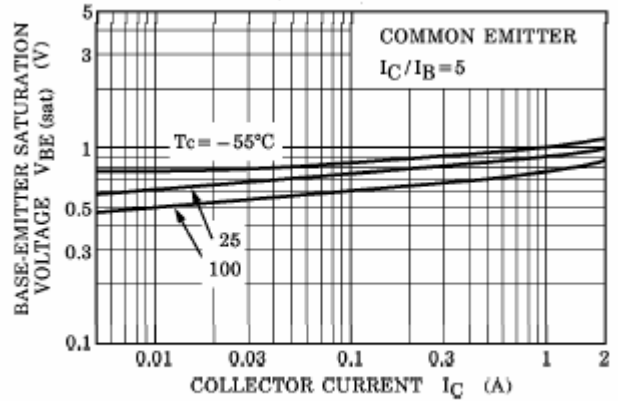

Fig.6 Base-Emitter Saturation Voltage

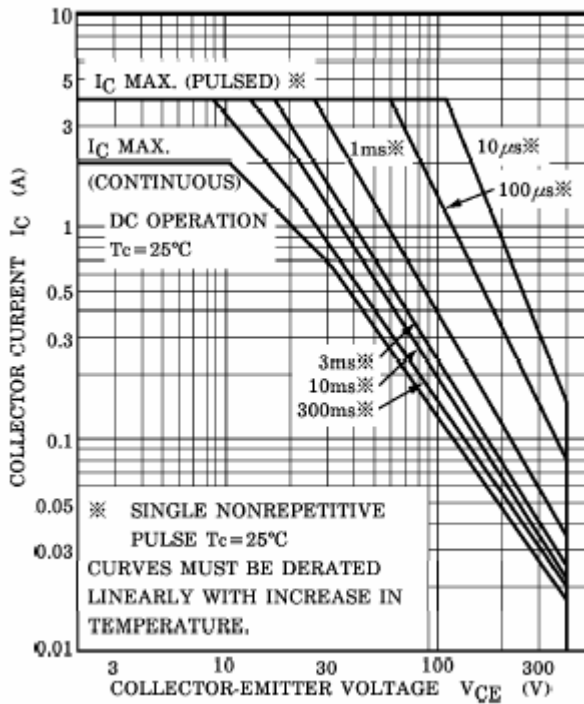

Fig.7 Safe Operating Area