

Silicon NPN Power Transistors

2SC2562

DESCRIPTION

- With TO-220 package
- Complement to type 2SA1012
- Low saturation voltage
- High speed switching time

APPLICATIONS

- High current switching applications

PINNING

PIN	DESCRIPTION
1	Base
2	Collector;connected to mounting base
3	Emitter

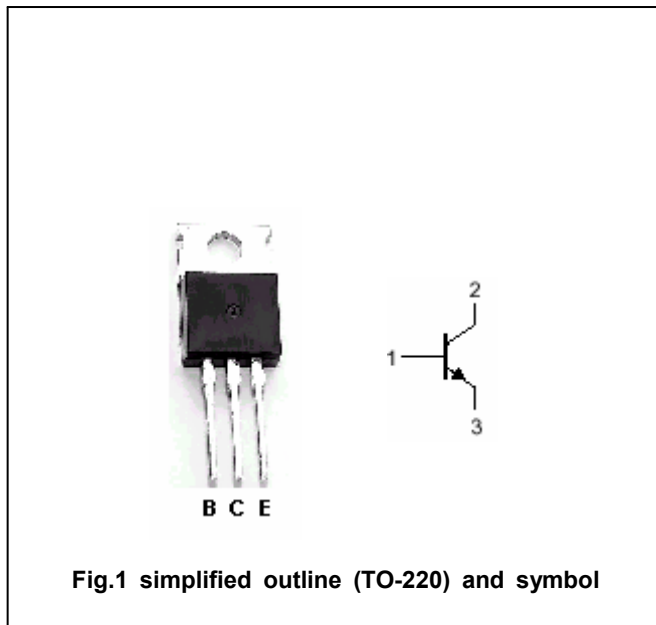

Absolute maximum ratings(Ta=25°C)

SYMBOL	PARAMETER	CONDITIONS	VALUE	UNIT
V _{CBO}	Collector-base voltage	Open emitter	60	V
V _{CEO}	Collector-emitter voltage	Open base	50	V
V _{EBO}	Emitter-base voltage	Open collector	5	V
I _C	Collector current		5	A
I _B	Base current		1	A
P _T	Total power dissipation	T _C =25°C	25	W
T _j	Junction temperature		150	°C
T _{stg}	Storage temperature		-55~150	°C

Silicon NPN Power Transistors

2SC2562

CHARACTERISTICS

T_j=25 °C unless otherwise specified

SYMBOL	PARAMETER	CONDITIONS	MIN	TYP.	MAX	UNIT
V _{(BR)CEO}	Base-emitter breakdown voltage	I _C =10mA, I _B =0	50			V
V _{CEsat}	Collector-emitter saturation voltage	I _C =3A; I _B =0.15A			0.4	V
V _{BEsat}	Base-emitter saturation voltage	I _C =3A; I _B =0.15A			1.2	V
I _{CBO}	Collector cut-off current	V _{CB} =50V; I _E =0			1	μA
I _{EBO}	Emitter cut-off current	V _{EB} =5V; I _C =0			1	μA
h _{FE-1}	DC current gain	I _C =1A; V _{CE} =1V	70		240	
h _{FE-2}	DC current gain	I _C =3A; V _{CE} =1V	30			
f _T	Transition frequency	I _C =1A; V _{CE} =4V		120		MHz
C _{ob}	Output capacitance	f=1MHz; V _{CB} =10V		80		pF

Switching times

t _{on}	Turn-on time	I _C =3A; I _{B1} =- I _{B2} =0.15A R _L =10Ω, V _{CC} =30V		0.1		μs
t _s	Storage time			1.0		μs
t _f	Fall time			0.1		μs

◆ h_{FE-1} Classifications

O	Y
70-140	120-240

Silicon NPN Power Transistors

2SC2562

PACKAGE OUTLINE

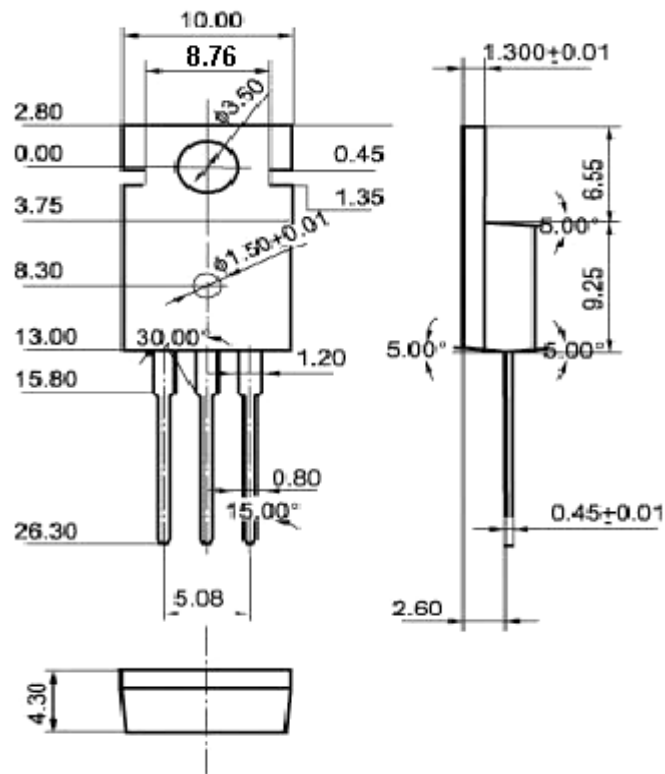

Fig.2 Outline dimensions(unindicated tolerance:±0.10 mm)

Silicon NPN Power Transistors

2SC2562

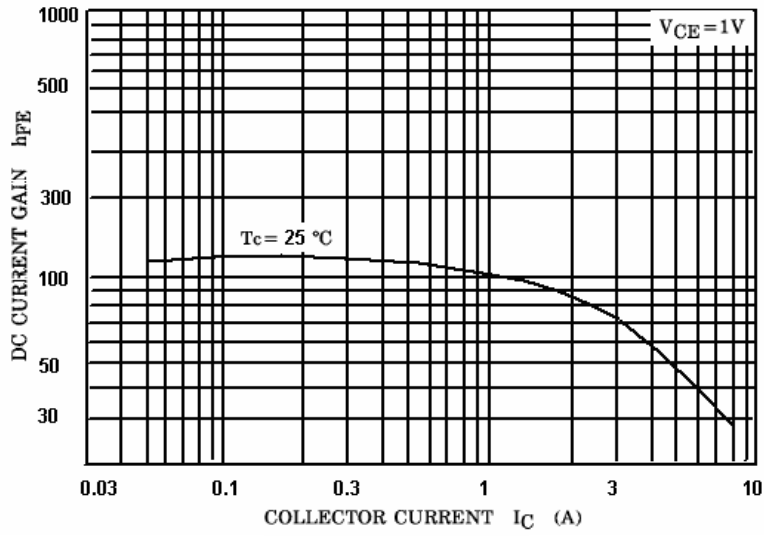

Fig.3 DC current Gain

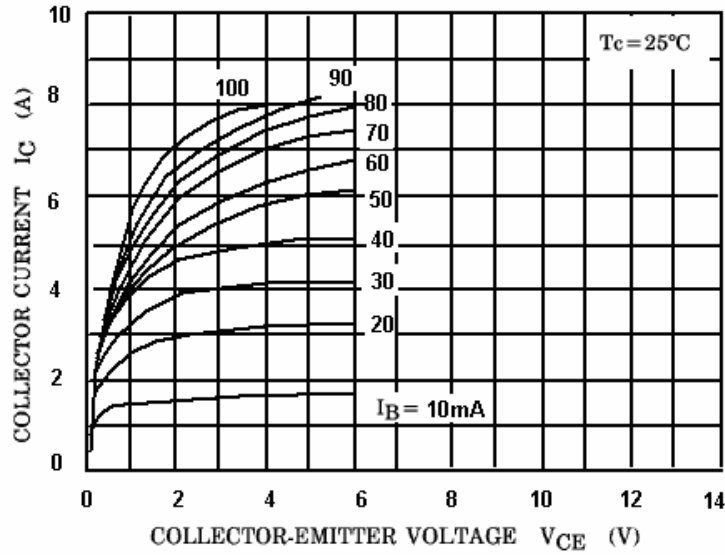

Fig.4 Static Characteristic

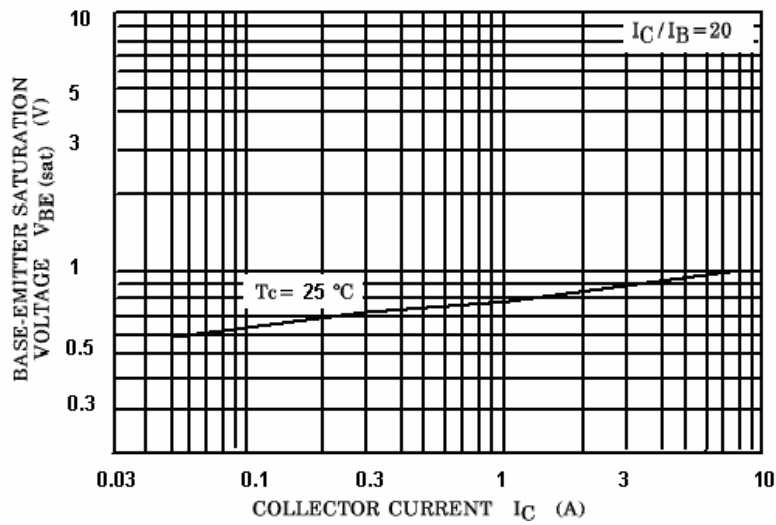

Fig.5 Base-Emitter Saturation Voltage

Silicon NPN Power Transistors

2SC2562

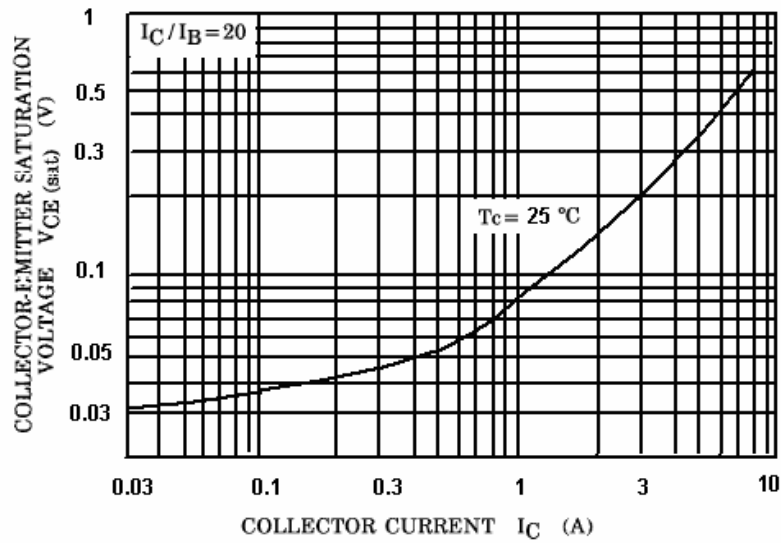

Fig.6 Collector-Emitter Saturation Voltage

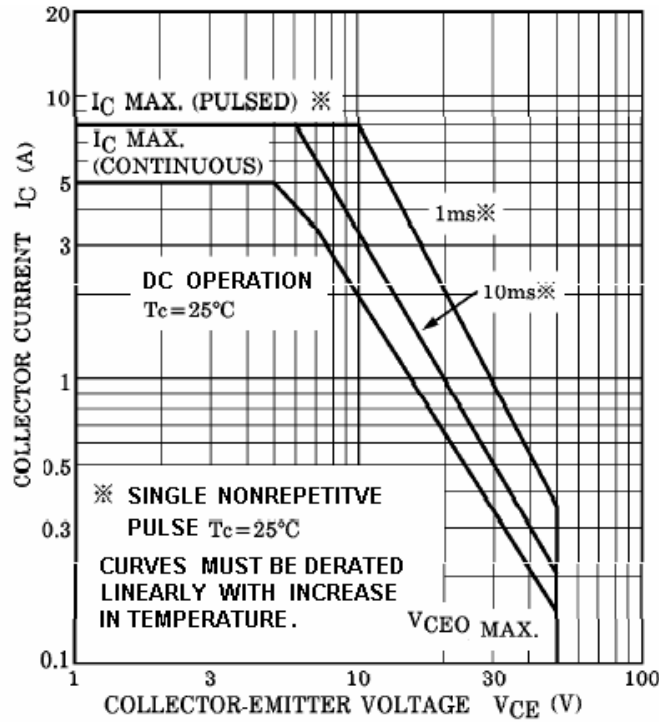

Fig.7 Safe Operating Area