

Silicon PNP Power Transistors

2SB1056

DESCRIPTION

- With TO-3PFa package
- Complement to type 2SD1487
- High f_T
- Satisfactory linearity of h_{FE}
- Wide area of safe operation

APPLICATIONS

- For high power amplifier applications

PINNING

PIN	DESCRIPTION
1	Base
2	Collector
3	Emitter

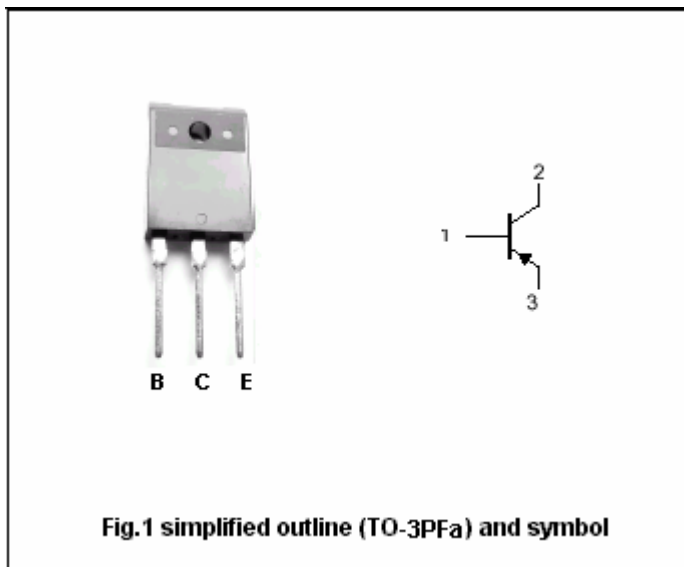

Absolute maximum ratings($T_a=25^\circ\text{C}$)

SYMBOL	PARAMETER	CONDITIONS	VALUE	UNIT
V_{CBO}	Collector-base voltage	Open emitter	-140	V
V_{CEO}	Collector-emitter voltage	Open base	-140	V
V_{EBO}	Emitter-base voltage	Open collector	-5	V
I_C	Collector current		-7	A
I_{CP}	Collector current-peak		-12	A
P_C	Collector power dissipation	$T_C=25^\circ\text{C}$	80	W
			3	
T_j	Junction temperature		150	$^\circ\text{C}$
T_{stg}	Storage temperature		-55~150	$^\circ\text{C}$

Silicon PNP Power Transistors

2SB1056

CHARACTERISTICS

T_j=25 °C unless otherwise specified

SYMBOL	PARAMETER	CONDITIONS	MIN	TYP.	MAX	UNIT
V _{CEsat}	Collector-emitter saturation voltage	I _C =-5A ; I _B =-0.5A			-2.0	V
V _{BE}	Base-emitter on voltage	I _C =-5A ; V _{CE} =-5V			-1.8	V
I _{CBO}	Collector cut-off current	V _{CB} =-140V; I _E =0			-50	μA
I _{EBO}	Emitter cut-off current	V _{EB} =-3V; I _C =0			-50	μA
h _{FE-1}	DC current gain	I _C =-20mA ; V _{CE} =-5V	20			
h _{FE-2}	DC current gain	I _C =-1A ; V _{CE} =-5V	40		200	
h _{FE-3}	DC current gain	I _C =-5A ; V _{CE} =-5V	20			
C _{OB}	Output capacitance	I _E =0 ; V _{CB} =-10V; f=1MHz		330		pF
f _T	Transition frequency	I _C =-0.5A ; V _{CE} =-5V		20		MHz

◆ h_{FE-2} classifications

R	Q	P
40-80	60-120	100-200

Silicon PNP Power Transistors

2SB1056

PACKAGE OUTLINE

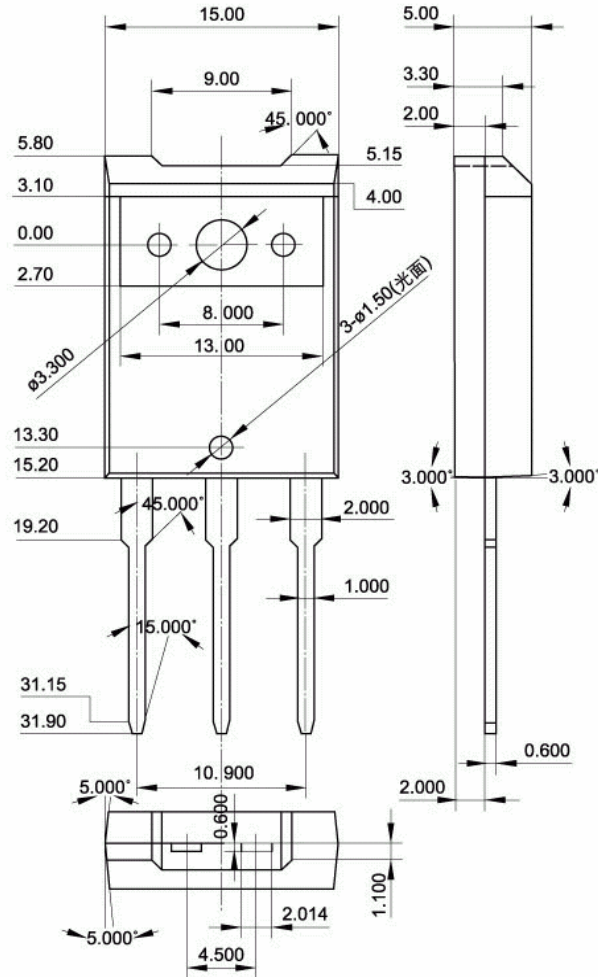

Fig.2 Outline dimensions (unindicated tolerance:±0.30mm)