

Silicon PNP Power Transistors

2SB744 2SB744A

DESCRIPTION

With TO-126 package

·Complement to type 2SD794/794A

·Excellent h_{FE} linearity

APPLICATIONS

·For audio frequency power amplifier and general purpose applications

PINNING

PIN	DESCRIPTION
1	Emitter
2	Collector;connected to mounting base
3	Base

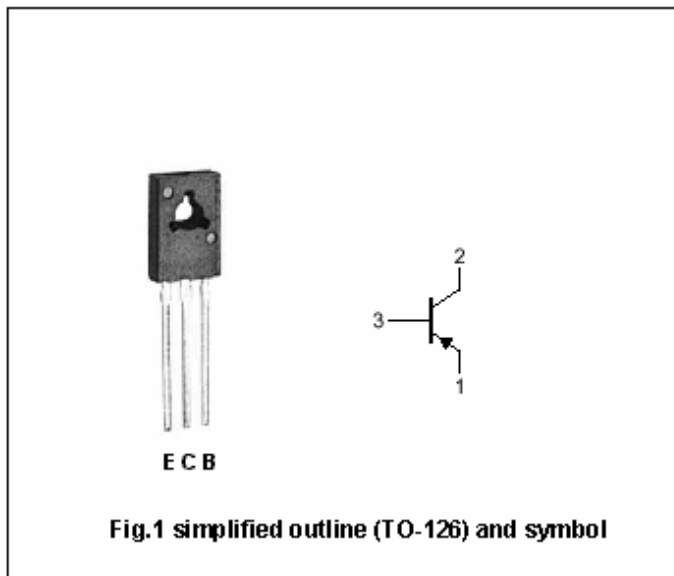

Absolute maximum ratings($T_a=25^\circ C$)

SYMBOL	PARAMETER	CONDITIONS	VALUE	UNIT
V_{CBO}	Collector-base voltage	Open emitter	-70	V
V_{CEO}	Collector-emitter voltage	2SB744	-45	V
		2SB744A	-60	
V_{EBO}	Emitter-base voltage	Open collector	-5	V
I_C	Collector current (DC)		-3	A
I_{CM}	Collector current-Peak		-5	A
I_B	Base current		-0.6	A
P_C	Collector power dissipation	$T_a=25^\circ C$	1	W
		$T_C=25^\circ C$	10	
T_j	Junction temperature		150	$^\circ C$
T_{stg}	Storage temperature		-55~150	$^\circ C$

Silicon PNP Power Transistors

2SB744 2SB744A

CHARACTERISTICS

T_j=25°C unless otherwise specified

SYMBOL	PARAMETER		CONDITIONS	MIN	TYP.	MAX	UNIT
V _{(BR)CEO}	Collector-emitter breakdown voltage	2SB744	I _C =-10mA; I _B =0	-45			V
		2SB744A		-60			
V _{CEsat}	Collector-emitter saturation voltage		I _C =-1.5A; I _B =-0.15A		-0.5	-2.0	V
V _{BEsat}	Base-emitter saturation voltage		I _C =-1.5A; I _B =-0.15A		-0.8	-2.0	V
I _{CBO}	Collector cut-off current		V _{CB} =-45V; I _E =0			-1	μA
I _{EBO}	Emitter cut-off current		V _{EB} =-3V; I _C =0			-1	μA
h _{FE-1}	DC current gain		I _C =-20mA; V _{CE} =-5V	30	120		
h _{FE-2}	DC current gain		I _C =-0.5A; V _{CE} =-5V	60	100	320	
f _T	Transition frequency		I _C =-0.1A; V _{CE} =-5V		45		MHz
C _{OB}	Collector output capacitance		f=1MHz; V _{CB} =-10V; I _E =0		60		pF

◆ h_{FE-2} Classifications

R	O	Y
60-120	100-200	160-320

Silicon PNP Power Transistors

2SB744 2SB744A

PACKAGE OUTLINE

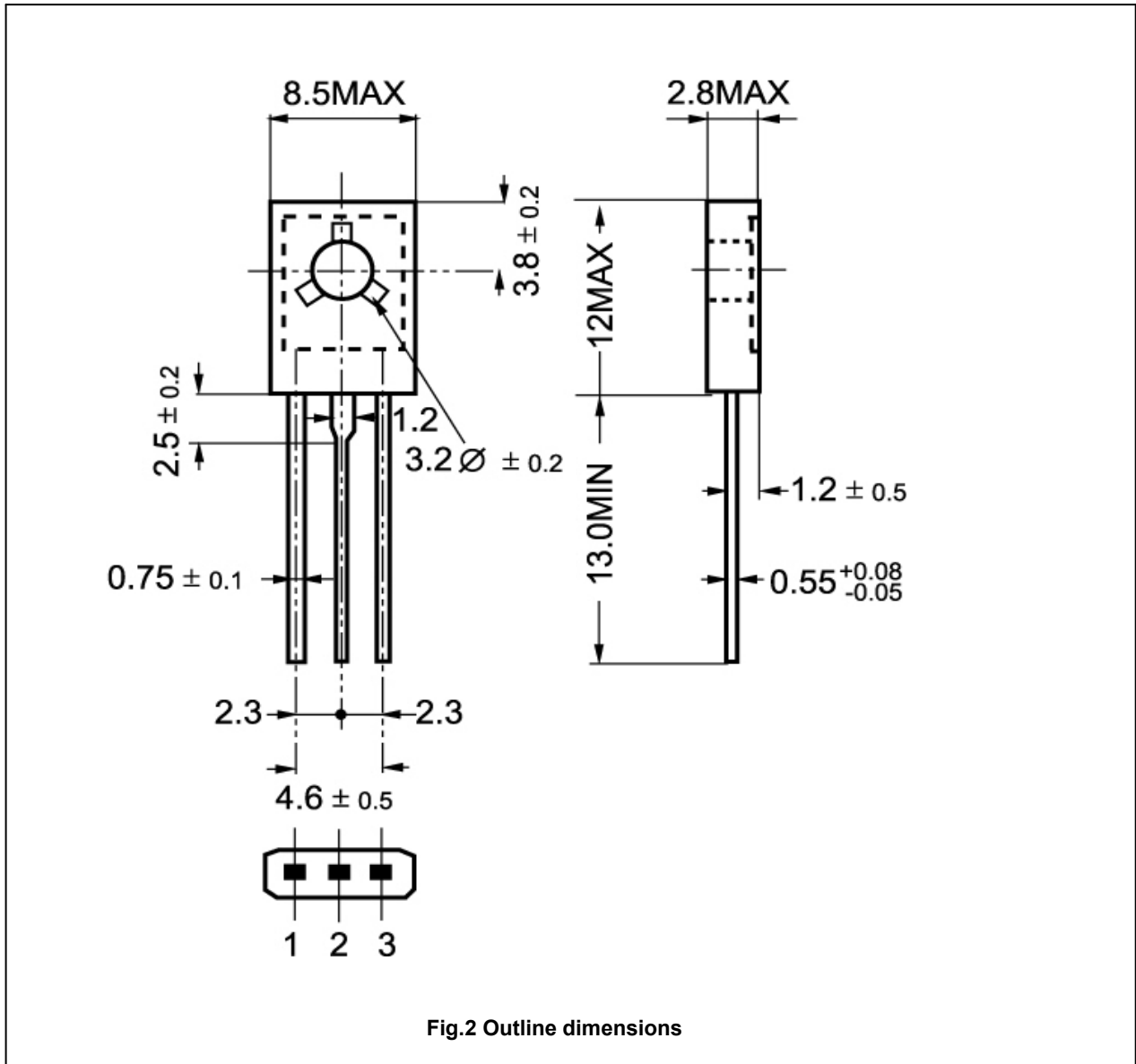

Silicon PNP Power Transistors

2SB744 2SB744A

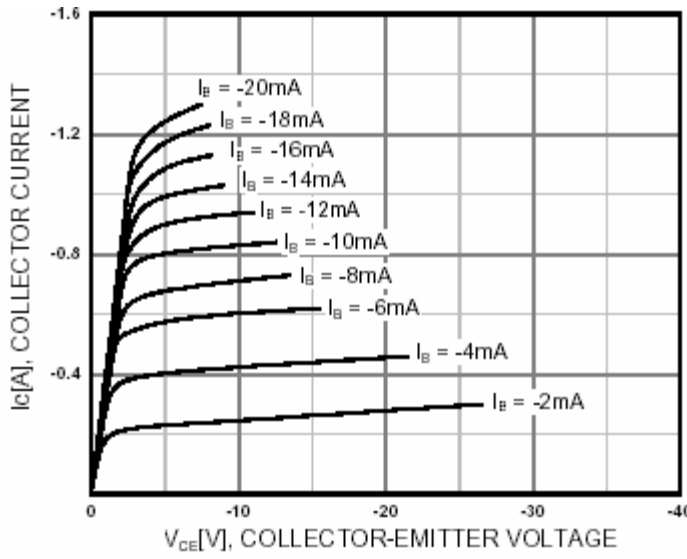

Fig.3 Static Characteristic

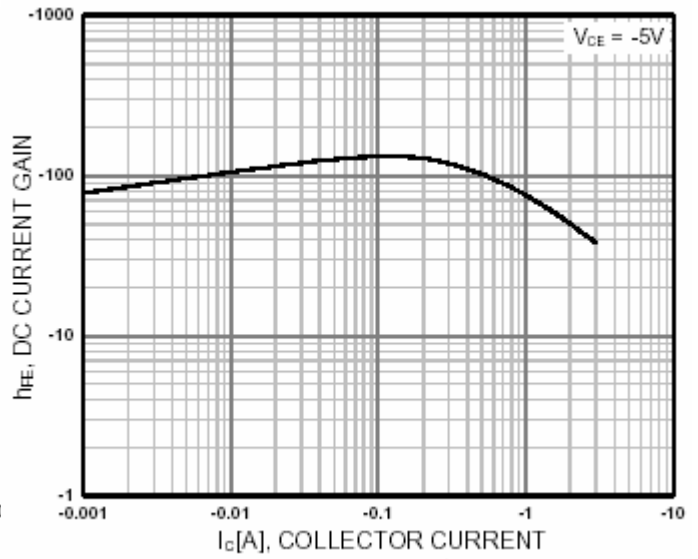

Fig.4 DC current Gain

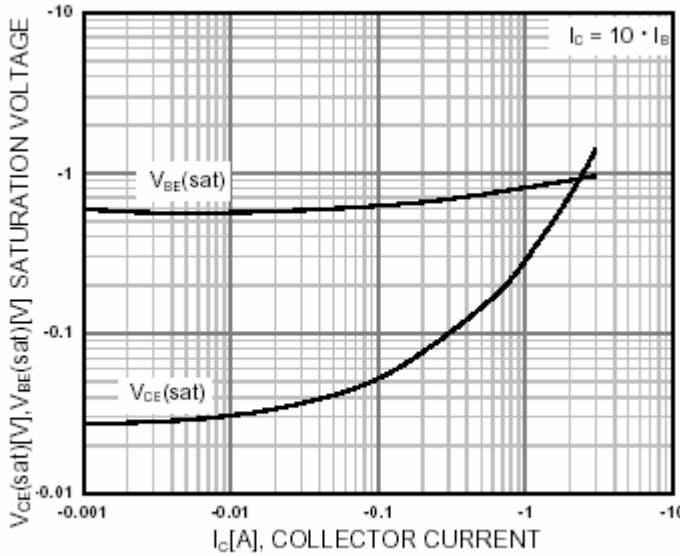

Fig.5 Base-Emitter Saturation Voltage
Collector-Emitter Saturation Voltage

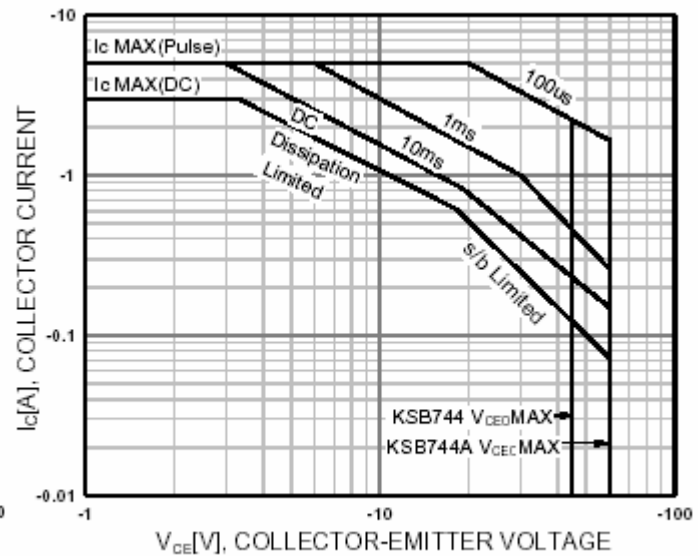

Fig.6 Safe Operating Area

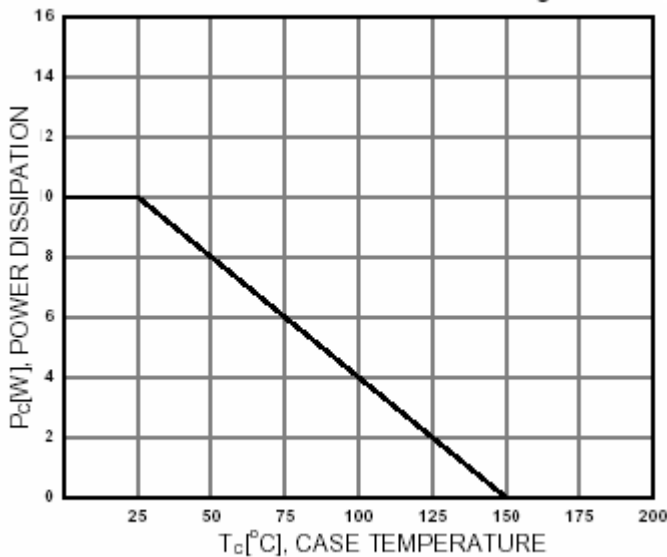

Fig.7 Power Derating