

Normally – OFF Silicon Carbide Junction Transistor

V_{DS}	=	1200 V
$V_{DS(ON)}$	=	1.2 V
I_D	=	6 A
$R_{DS(ON)}$	=	200 mΩ

Features

- 175 °C maximum operating temperature
- Temperature independent switching performance
- Gate oxide free SiC switch
- Suitable for connecting an anti-parallel diode
- Positive temperature coefficient for easy paralleling
- Low gate charge
- Low intrinsic capacitance

Package

- RoHS Compliant

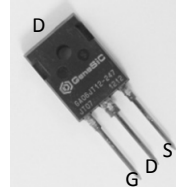
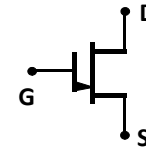
TO-247AB

Advantages

- SiC transistor most compatible with existing Si gate-drivers
- Low switching losses
- Higher efficiency
- High temperature operation
- High short circuit withstand capability

Applications

- Down Hole Oil Drilling, Geothermal Instrumentation
- Hybrid Electric Vehicles (HEV)
- Solar Inverters
- Switched-Mode Power Supply (SMPS)
- Power Factor Correction (PFC)
- Induction Heating
- Uninterruptible Power Supply (UPS)
- Motor Drives

Absolute Maximum Ratings

Parameter	Symbol	Conditions	Values	Unit
Drain – Source Voltage	V_{DS}	$V_{GS} = 0 V$	1200	V
Continuous Drain Current	I_D	$T_{C,MAX} = 90 °C$	6	A
Gate Peak Current	I_{GM}		5	A
Turn-Off Safe Operating Area	RBSOA	$T_{VJ} = 175 °C, I_G = 1 A,$ Clamped Inductive Load	$I_{D,max} = 6$ @ $V_{DS} \leq V_{DSmax}$	A
Short Circuit Safe Operating Area	SCSOA	$T_{VJ} = 175 °C, I_G = 1 A, V_{DS} = 800 V,$ Non Repetitive	20	μs
Reverse Gate – Source Voltage	V_{SG}		30	V
Reverse Drain – Source Voltage	V_{SD}		40	V
Power Dissipation	P_{tot}	$T_C = 25 °C$	146	W
Storage Temperature	T_{stg}		-55 to 175	$°C$

Electrical Characteristics

Parameter	Symbol	Conditions	Values			Unit
			min.	typ.	max.	

On Characteristics

Drain – Source On Voltage	$V_{DS(ON)}$	$I_D = 6 A, I_G = 500 mA, T_J = 25 °C$	1.2	1.7	V
		$I_D = 6 A, I_G = 1000 mA, T_J = 125 °C$	1.7	2.2	
		$I_D = 6 A, I_G = 1000 mA, T_J = 175 °C$	2.2	3.0	
Drain – Source On Resistance	$R_{DS(ON)}$	$I_D = 6 A, I_G = 500 mA, T_J = 25 °C$	200		mΩ
		$I_D = 6 A, I_G = 1000 mA, T_J = 125 °C$	280		
		$I_D = 6 A, I_G = 1000 mA, T_J = 175 °C$	370		
Gate Forward Voltage	$V_{GS(FWD)}$	$I_G = 500 mA, T_J = 25 °C$ $I_G = 500 mA, T_J = 175 °C$	3.1 2.9		V
DC Current Gain	β	$V_{DS} = 5 V, I_D = 6 A, T_J = 25 °C$	45	53	
		$V_{DS} = 5 V, I_D = 6 A, T_J = 175 °C$		33	

Off Characteristics

Drain Leakage Current	I_{DSS}	$V_R = 1200 V, V_{GS} = 0 V, T_J = 25 °C$	0.5	10	μA
		$V_R = 1200 V, V_{GS} = 0 V, T_J = 125 °C$	1	50	
		$V_R = 1200 V, V_{GS} = 0 V, T_J = 175 °C$	2	100	
Gate Leakage Current	I_{SG}	$V_{SG} = 20 V, T_J = 25 °C$	20		nA

Electrical Characteristics

Parameter	Symbol	Conditions	Values			Unit	
			min.	typ.	max.		
Capacitance Characteristics							
Gate-Source Capacitance	C_{GS}	$V_{GS} = 0\text{ V}, f = 1\text{ MHz}$		660		pF	
Input Capacitance	C_{ISS}	$V_{GS} = 0\text{ V}, V_D = 1\text{ V}, f = 1\text{ MHz}$		900		pF	
Reverse Transfer/Output Capacitance	C_{RSS}/C_{OSS}	$V_D = 1\text{ V}, f = 1\text{ MHz}$		240		pF	
Switching Characteristics							
Turn On Delay Time	$t_{d(on)}$	$T_J = 25\text{ }^\circ\text{C}, V_{DS} = 800\text{ V}, I_D = 6\text{ A},$ Two-Level Gate Drive, $R_G = 1.5\ \Omega, C_G = 9\text{ nF},$ $V_{GH} = 20\text{ V}, V_{GL} = 6\text{ V}, V_{EE} = -5\text{ V},$ IXDD614 Gate Drive IC, $L = 1.05\text{ mH}, \text{FWD} = \text{GB05SLT12},$ Refer to Fig. 15 for gate current waveform		15		ns	
Rise Time, Drain Current	t_r			10		ns	
Turn Off Delay Time	$t_{d(off)}$			55		ns	
Fall Time, Drain Current	t_f			50		ns	
Turn-On Energy Per Pulse	E_{on}			175		μJ	
Turn-Off Energy Per Pulse	E_{off}			45		μJ	
Total Switching Energy	E_{ts}			220		μJ	
Turn On Delay Time	$t_{d(on)}$		$T_J = 175\text{ }^\circ\text{C}, V_{DS} = 800\text{ V}, I_D = 6\text{ A},$ Two-Level Gate Drive, $R_G = 1.5\ \Omega, C_G = 9\text{ nF},$ $V_{GH} = 20\text{ V}, V_{GL} = 6\text{ V}, V_{EE} = -5\text{ V},$ IXDD614 Gate Drive IC, $L = 1.05\text{ mH}, \text{FWD} = \text{GB05SLT12},$ Refer to Fig. 15 for gate current waveform		10		ns
Rise Time, Drain Current	t_r				10		ns
Turn Off Delay Time	$t_{d(off)}$				80		ns
Fall Time, Drain Current	t_f				45		ns
Turn-On Energy Per Pulse	E_{on}				115		μJ
Turn-Off Energy Per Pulse	E_{off}			55		μJ	
Total Switching Energy	E_{ts}			215		μJ	

Thermal Characteristics

Thermal resistance, junction - case	R_{thJC}	1.03	$^\circ\text{C/W}$
-------------------------------------	------------	------	--------------------

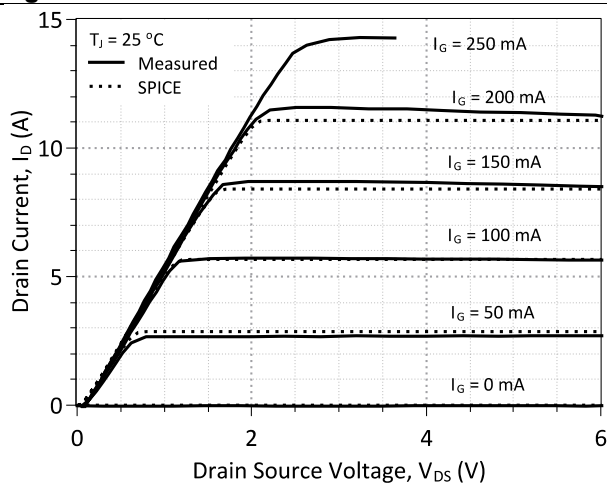
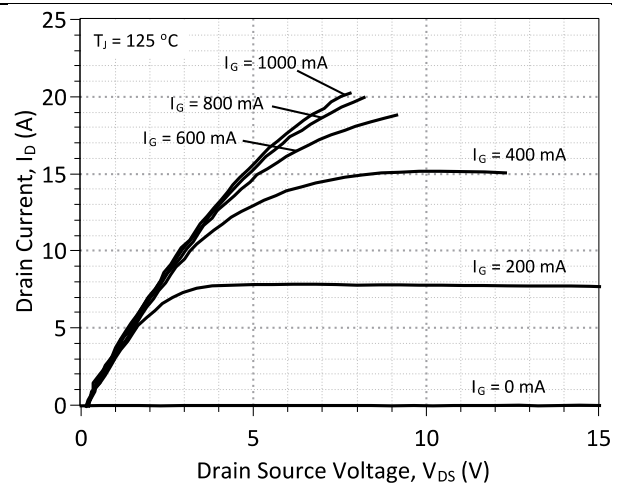
Figures

Figure 1: Typical Output Characteristics at 25 °C

Figure 2: Typical Output Characteristics at 125 °C

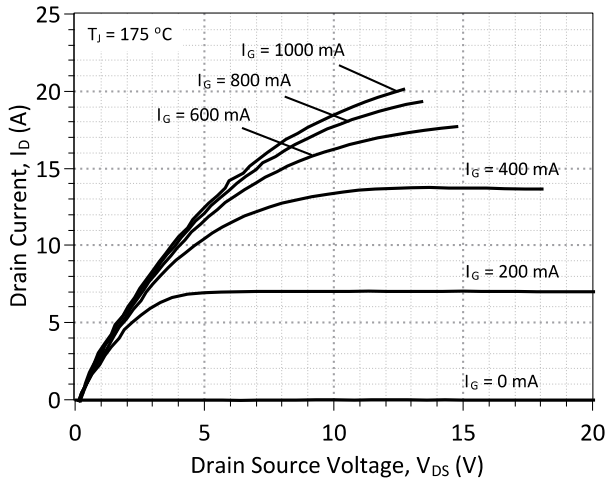

Figure 3: Typical Output Characteristics at 175 °C

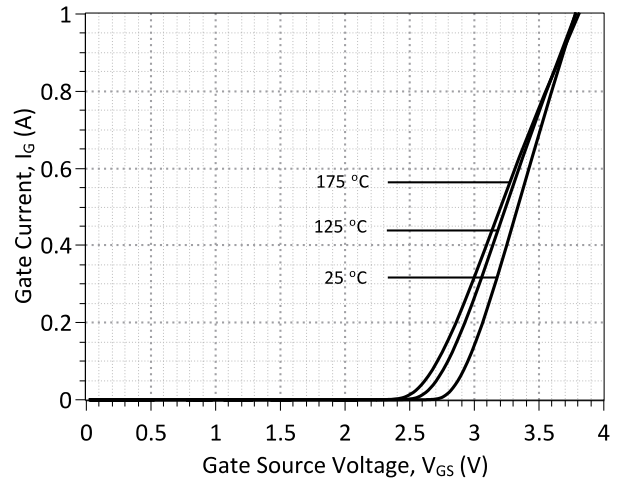

Figure 4: Typical Gate Source I-V Characteristics vs. Temperature

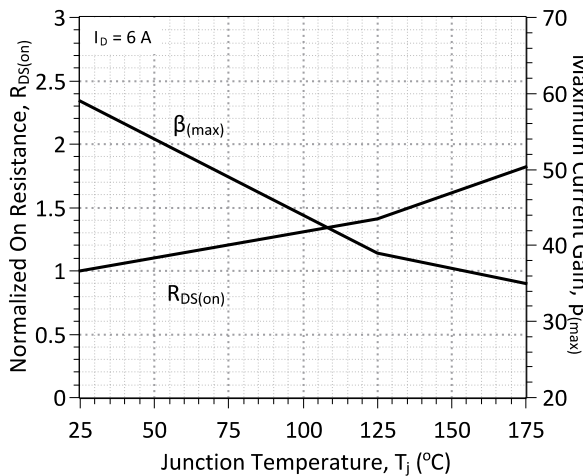

Figure 5: Normalized On-Resistance and Current Gain vs. Temperature

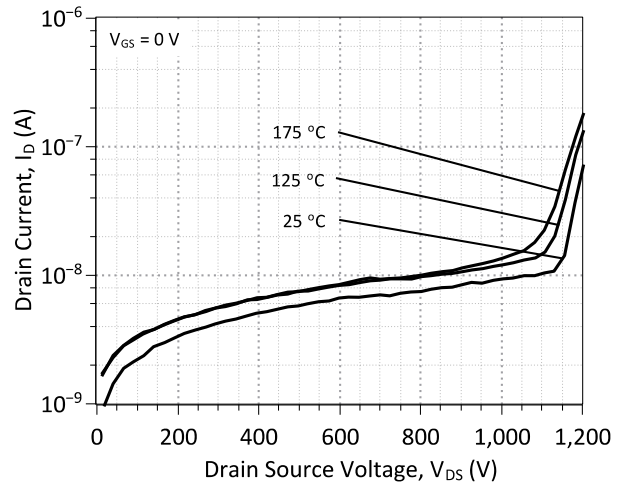

Figure 6: Typical Blocking Characteristics

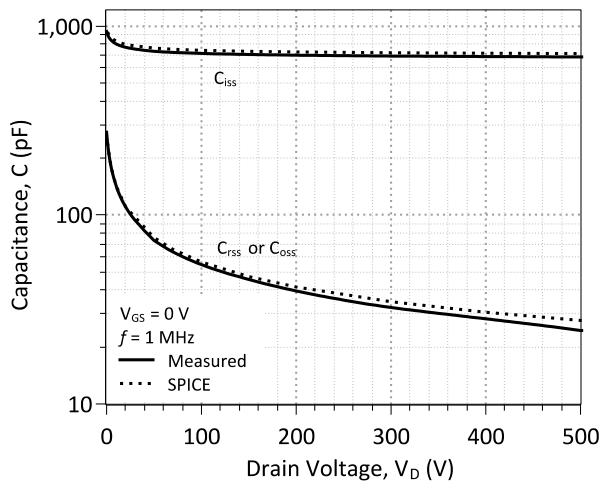

Figure 7: Capacitance Characteristics

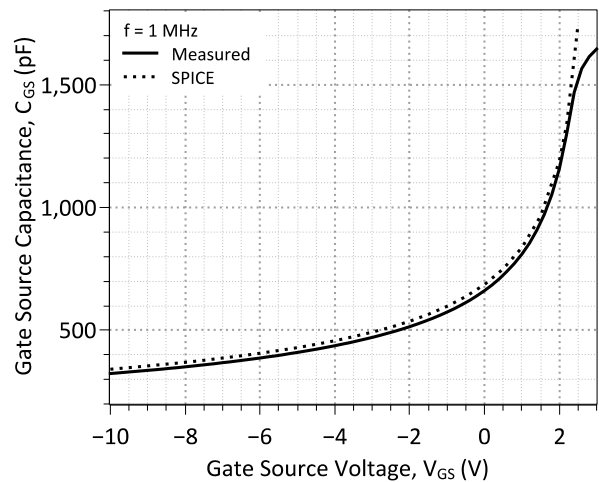

Figure 8: Capacitance Characteristics

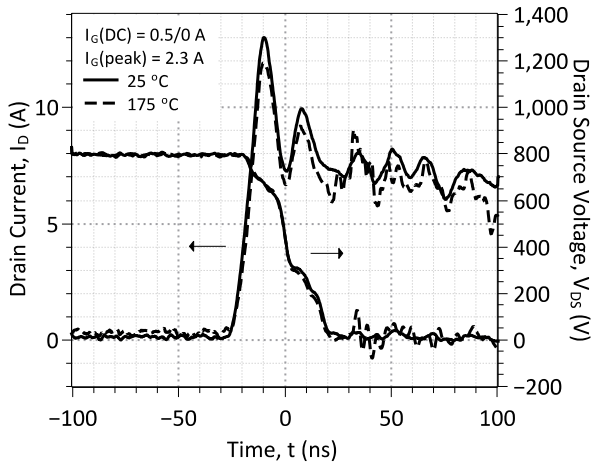

Figure 9: Typical Hard-switched Turn On Waveforms

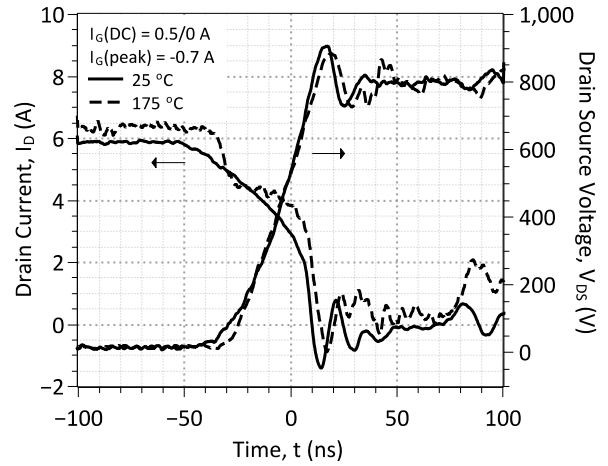

Figure 10: Typical Hard-switched Turn Off Waveforms

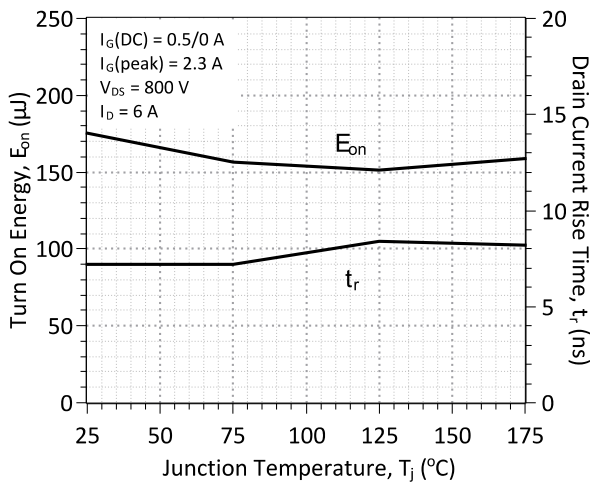

Figure 11: Typical Turn On Energy Losses and Switching Times vs. Temperature

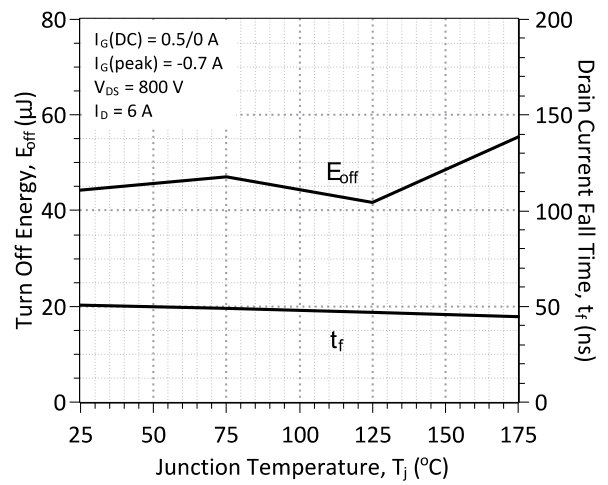

Figure 12: Typical Turn Off Energy Losses and Switching Times vs. Temperature

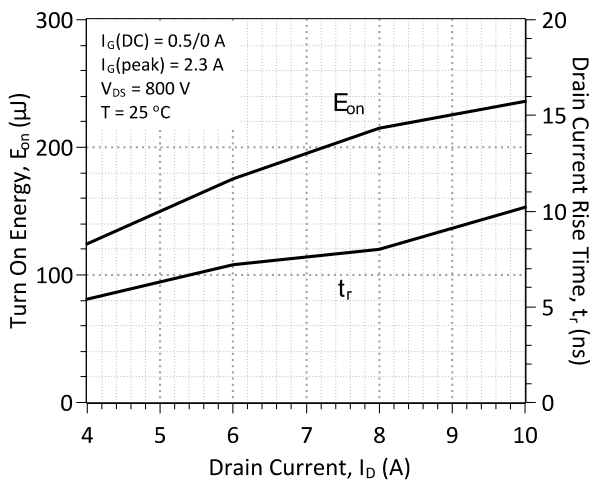

Figure 13: Typical Turn On Energy Losses vs. Drain Current

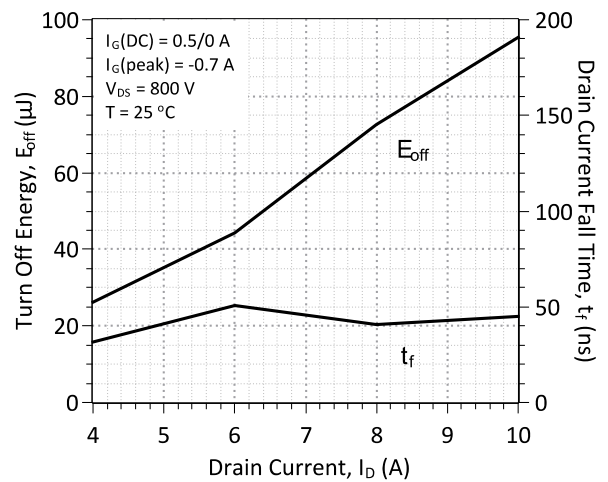

Figure 14: Typical Turn Off Energy Losses vs. Drain Current

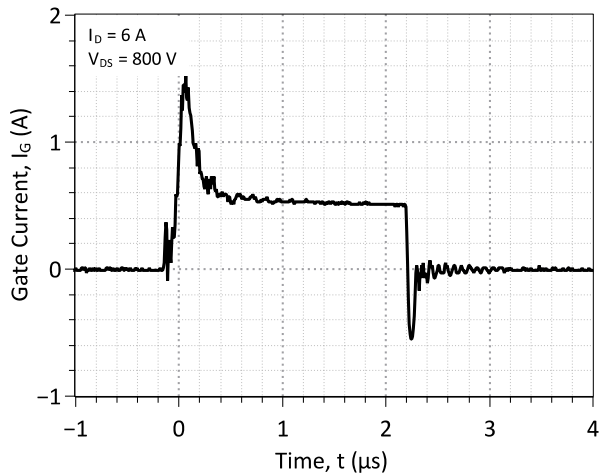

Figure 15: Typical Gate Current Waveform

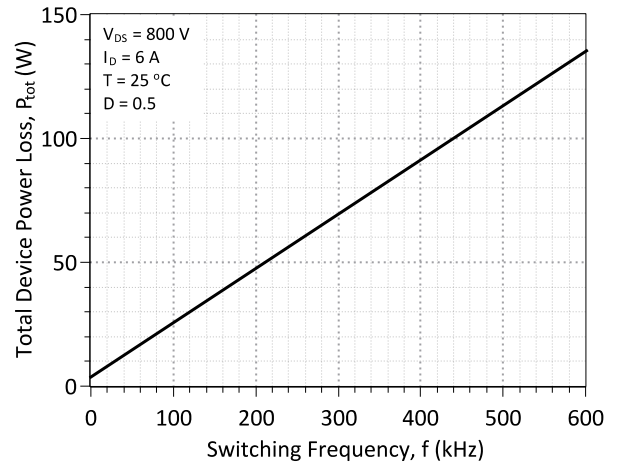

Figure 16: Typical Hard Switched Device Power Loss vs. Switching Frequency¹

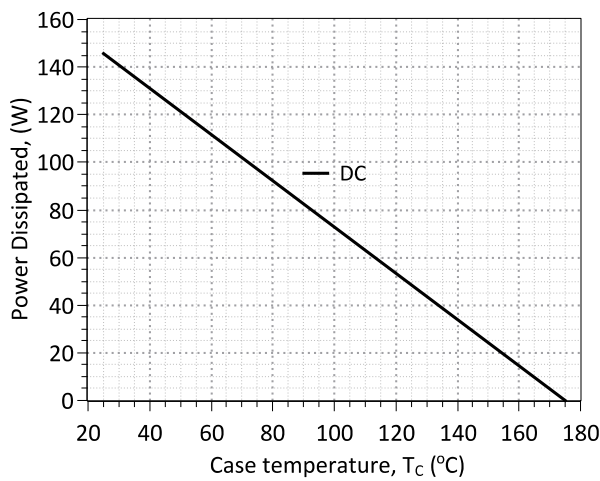

Figure 17: Power Derating Curve

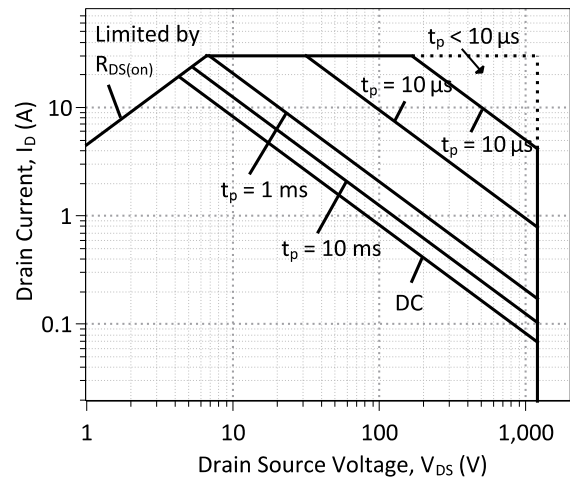

Figure 18: Forward Bias Safe Operating Area

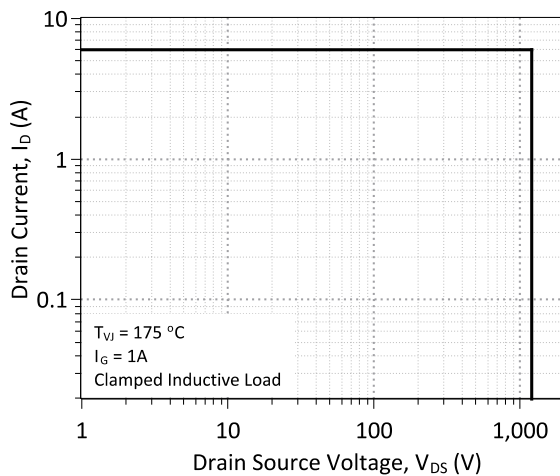

Figure 19: Turn-Off Safe Operating Area

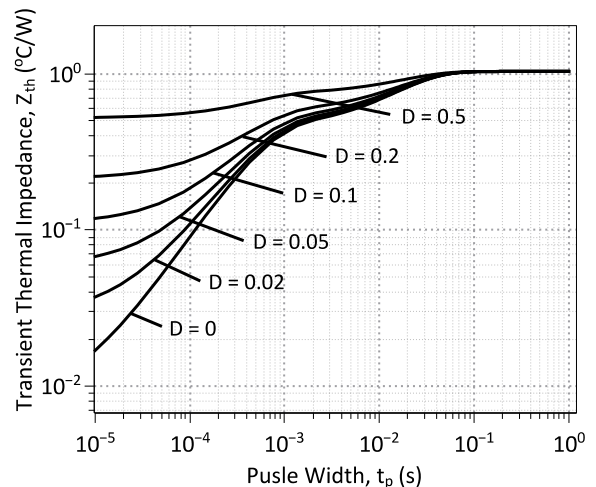

Figure 20: Transient Thermal Impedance

¹ – Representative values based on device switching energy loss. Actual losses will depend on gate drive conditions, device load, and circuit topology.

Commercial Gate Drivers Compatible with GA06JT12-247

Manufacturer	Part Number	Peak Current Capability	Peak Current Width Control	Available Features		
				Optical Signal Isolation	Desaturation Detection	Under Voltage Lockout
Avago Tech.	ACPL-322J	2.5	-	✓	✓	✓
IXYS	IXD_604	4.0	-	-	-	-
IXYS	IXD_609	9.0	-	-	-	-
IXYS	IXD_614	14.0	-	-	-	-
Micrel	MIC4452YN	12.0	-	-	-	-
Microsemi	LX1780QLQ	15.0	✓	-	-	✓
Texas Instruments	UCC27322	9.0	-	-	-	-

SiC SJTs do NOT require a current-driven gate driver. Modern Si IGBT drivers offer sufficient gate currents to drive SJTs. This is a partial list of widely available commercial Silicon IGBT/MOSFET gate drivers which may be used to drive the GA06JT12-247. Specific product information including advanced features and pinouts should be obtained from the individual product manufacturer's websites.

The GA06JT12-247 can be driven similar to silicon IGBTs or MOSFETs in which a gate driver IC is used to supply positive gate current peaks to the device at turn-on and negative current peaks at turn-off. Unlike the IGBT or MOSFET, the GA06JT12-247 also requires a continuous gate current for the device to remain on after the initial current peak. An example gate current waveform for the GA06JT12-247 is shown in Fig. 15.

Single-Level SJT Gate Drive

Producing the necessary gate current peaks and continuous currents can be accomplished by using a gate drive circuit shown in Fig. 21. The gate driver output node is connected to an NPN/PNP silicon BJT pair in a totem pole configuration which provide gate current to the SJT gate. The NPN/PNP pair are controlled by the gate drive IC connected through base resistor R_b . The pair's output at node N_1 is connected to gate resistor R_G and capacitor C_G placed in parallel and connected to the SJT gate terminal. The gate resistor determines the continuous gate current. The gate capacitor produces positive and negative current peaks, which enable fast charging and discharging of the SJT's terminal capacitances. Additional detail on the single-level SJT gate driving technique is discussed in GeneSiC Semiconductor Application Note AN-10A. (<http://www.genesicsemi.com/index.php/references/notes>)

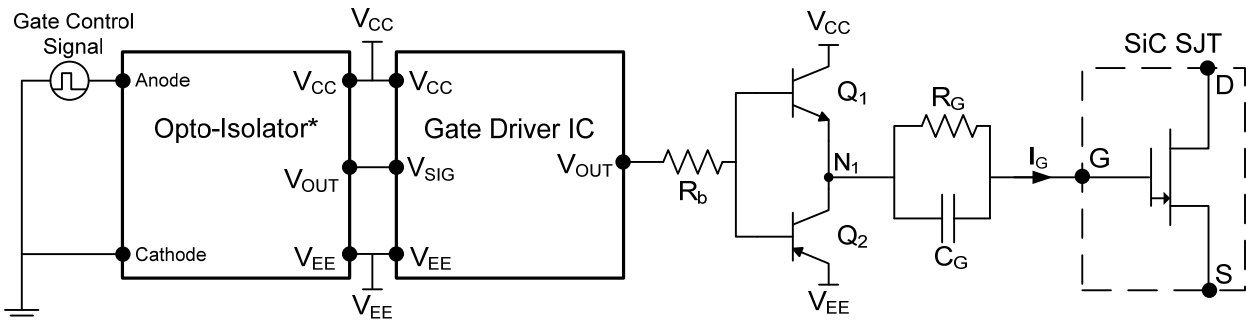

Figure 21: Single-Level SJT Gate Diver Configuration (* External signal isolation is recommended for non-isolated gate driver ICs.)

Single-Level Gate Drive Conditions

Parameter	Symbol	Conditions	Values			Unit
			Min.	Optimum	Max.	
Supply Voltage	V_{CC}			15	20	V
Negative Supply Voltage	V_{EE}		-10	-5		V
Output Current, Peak	$I_{OUT, pk}$	Package Limited,	1.0	1.5		A
Output Current, Continuous	I_{OUT}	$I_D = 6.0 \text{ A}, T = 175 \text{ }^\circ\text{C}$	0.3	0.5		A

Output Gate Components

Gate Resistance	R_G	$V_{CC} = 15 \text{ V}, I_G \approx 0.5 \text{ A}, T = 175 \text{ }^\circ\text{C}$	15	22		Ω
Gate Capacitance	C_G	$V_{CC} = 15 \text{ V}, I_{G, pk} \approx 1.5 \text{ A}, T = 175 \text{ }^\circ\text{C}$	5	9		nF
Base Resistor	R_b			10		Ω
NPN/PNP BJT Output Buffer	Q_1, Q_2	2N6107/2N6292 pair or equivalent **				

** - Complimentary BJT pair with $I_C \geq 5 \text{ A}$ and $V_{CEO} \geq 60 \text{ V}$

Two-Level SJT Gate Drive

The GA06JT12-247 can also be driven with a gate drive circuit shown in Fig. 22, in which two gate drive ICs and NPN/PNP pairs are operated with different supply voltage (V_{CC}) levels in order to minimize gate drive losses. By using a separate lower voltage output gate driver IC connected to gate resistor R_G , the power consumption of the continuous current is reduced. Additional detail on the two-level SJT gate driving technique is discussed in GeneSiC Semiconductor Application Note AN-10B. (<http://www.genesicsemi.com/index.php/references/notes>)

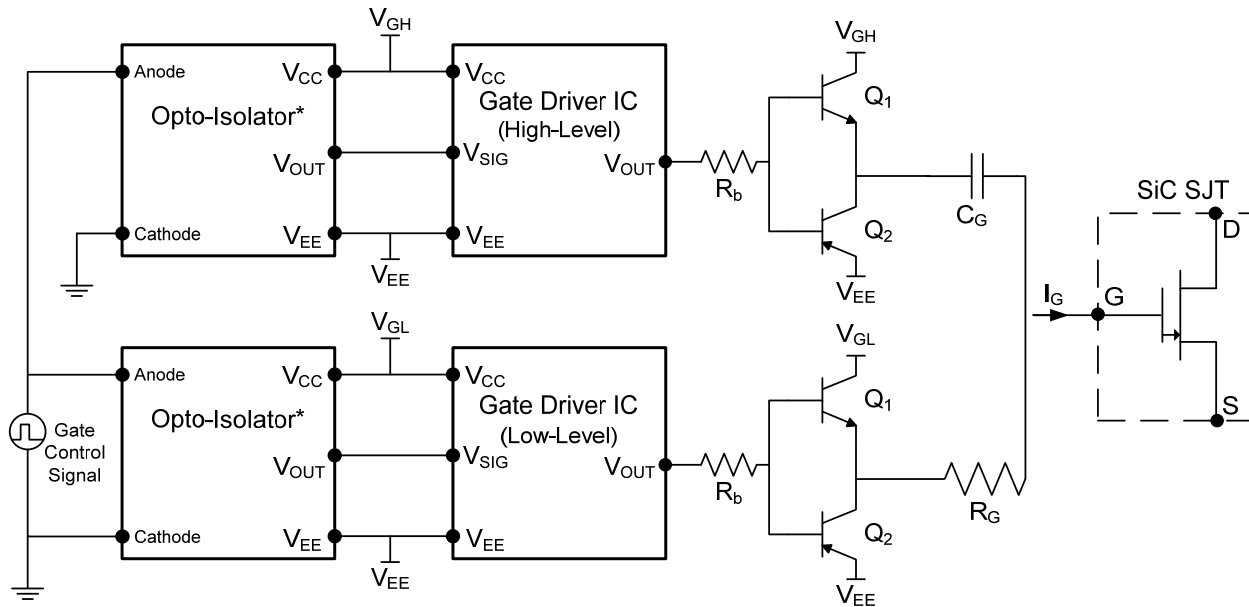

Figure 22: Two-Level SJT Gate Driver Configuration for Reduced Drive Losses (* External signal isolation is recommended for non-isolated gate driver ICs.)

Two-Level Gate Drive Conditions

Parameter	Symbol	Conditions	Values			Unit
			min.	Optimum	max.	
Supply Voltage, High Level Driver	$V_{CC}(V_{GH}^+)$		15	20		V
Supply Voltage, Low Level Driver	$V_{CC}(V_{GL}^+)$		5	6		V
Negative Supply Voltage	V_{EE}		-10	-5		V
Output Current, Peak	I_{OUT}	Package Limited,	1.0	1.5		A
Output Current, Continuous	I_{OUT}	$I_D = 6.0 \text{ A}, T = 175^\circ \text{C}$	0.3	0.5		A

Output Gate Components

Gate Resistance	R_G	$V_{GL} = 6.0 \text{ V}, I_G \approx 0.5 \text{ A}, T = 175^\circ \text{C}$	1.6	5		Ω
Gate Capacitance	C_G	$V_{GH} = 20 \text{ V}, I_{G,pk} \approx 1.5 \text{ A}, T = 175^\circ \text{C}$	5	9		nF
Base Resistor	R_b			10		Ω
NPN/PNP BJT Output Buffer	Q_1, Q_2	2N6107/2N6292 pair or equivalent**				

** - Complimentary BJT pair with $I_C \geq 5 \text{ A}$ and $V_{CEO} \geq 60 \text{ V}$

+ – Consult application note AN-10B for more information on parameters V_{GH} and V_{GL} .

Package Dimensions:

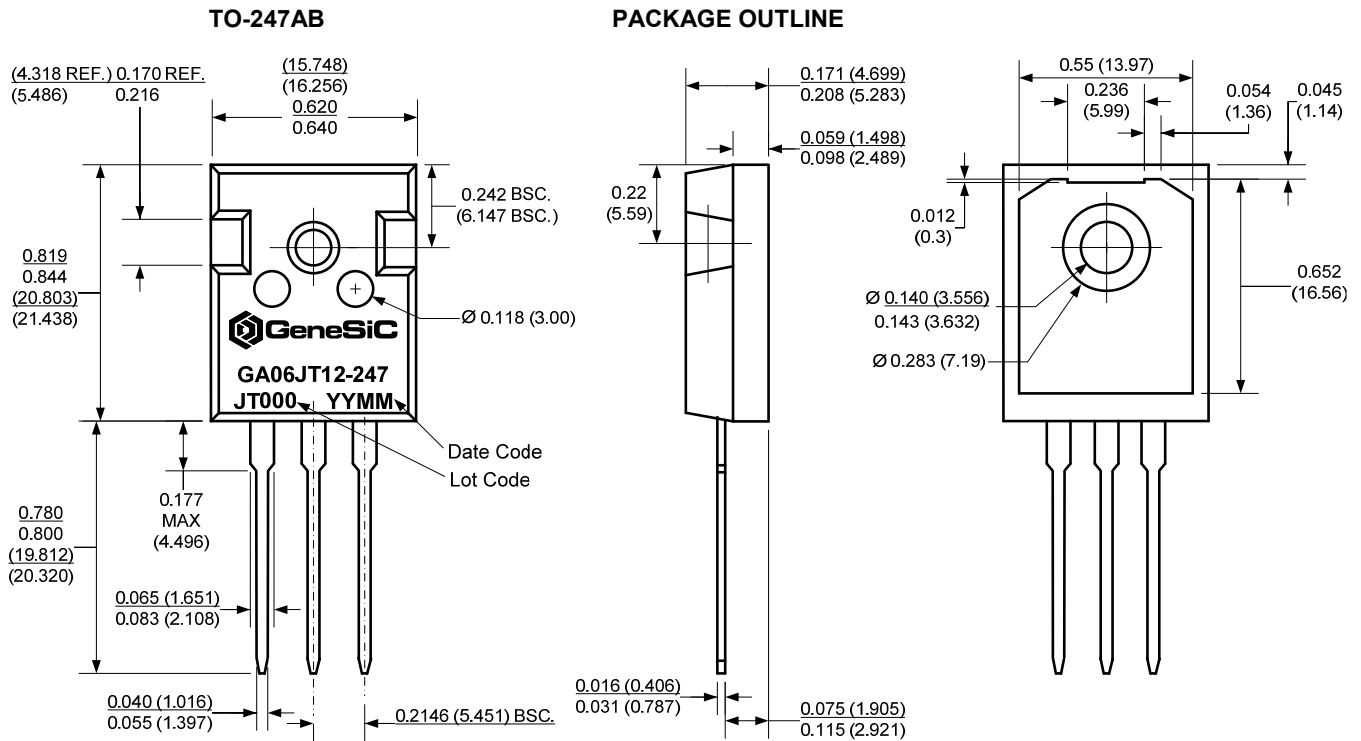

NOTE

1. CONTROLLED DIMENSION IS INCH. DIMENSION IN BRACKET IS MILLIMETER.
2. DIMENSIONS DO NOT INCLUDE END FLASH, MOLD FLASH, MATERIAL PROTRUSIONS

Revision History			
Date	Revision	Comments	Supersedes
2014/02/05	6	Updated Electrical Characteristics	
2013/12/18	5	Updated Gate Drive Section	
2013/11/13	4	Updated Electrical Characteristics	
2013/08/23	3	Updated Switching Characteristics	
2013/06/24	2	Updated Electrical Characteristics	
2013/02/21	1	Revised Electrical Characteristics	
2012/11/30	0	Initial Release	

Published by
 GeneSiC Semiconductor, Inc.
 43670 Trade Center Place Suite 155
 Dulles, VA 20166

GeneSiC Semiconductor, Inc. reserves right to make changes to the product specifications and data in this document without notice.

GeneSiC disclaims all and any warranty and liability arising out of use or application of any product. No license, express or implied to any intellectual property rights is granted by this document.

Unless otherwise expressly indicated, GeneSiC products are not designed, tested or authorized for use in life-saving, medical, aircraft navigation, communication, air traffic control and weapons systems, nor in applications where their failure may result in death, personal injury and/or property damage.

SPICE Model Parameters

This is a secure document. Please copy this code from the SPICE model PDF file on our website (http://www.genesicsemi.com/images/products_sic/sjt/GA06JT12-247_SPICE.pdf) into LTSPICE (version 4) software for simulation of the GA06JT12-247.

```
*      MODEL OF GeneSiC Semiconductor Inc.
*
*      $Revision:   1.0           $
*      $Date:      26-AUG-2013   $
*
*      GeneSiC Semiconductor Inc.
*      43670 Trade Center Place Ste. 155
*      Dulles, VA 20166
*
*      COPYRIGHT (C) 2013 GeneSiC Semiconductor Inc.
*      ALL RIGHTS RESERVED
*
*      These models are provided "AS IS, WHERE IS, AND WITH NO WARRANTY
*      OF ANY KIND EITHER EXPRESSED OR IMPLIED, INCLUDING BUT NOT LIMITED
*      TO ANY IMPLIED WARRANTIES OF MERCHANTABILITY AND FITNESS FOR A
*      PARTICULAR PURPOSE."
*      Models accurate up to 2 times rated drain current.
*
.model GA06JT12 NPN
+ IS      5.08E-47
+ ISE     1.26E-28
+ EG      3.2
+ BF      58.31
+ BR      0.55
+ IKF     200
+ NF      1
+ NE      1.892
+ RB      0.26
+ RE      0.1039
+ RC      0.06188
+ CJC     2.73E-10
+ VJC     3.04
+ MJC     0.448
+ CJE     6.86E-10
+ VJE     2.89
+ MJE     0.466
+ XTI     3
+ XTB     -1.33
+ TRC1    1.90E-2
+ VCEO    1200
+ ICRATING 6
+ MFG     GeneSiC_Semiconductor
*
*      End of GA06JT12 SPICE Model
```