

# Complementary MOSFET

## ELM34608AA-N

### ■ General Description

ELM34608AA-N uses advanced trench technology to provide excellent  $R_{ds(on)}$  and low gate charge.

### ■ Features

- |  |  |
|--|--|
| N-channel                                | P-channel                                |
| • $V_{ds}=60V$                           | $V_{ds}=-60V$                            |
| • $I_d=4.5A$                             | $I_d=-3.5A$                              |
| • $R_{ds(on)} < 58m\Omega (V_{gs}=10V)$  | $R_{ds(on)} < 90m\Omega (V_{gs}=-10V)$   |
| • $R_{ds(on)} < 85m\Omega (V_{gs}=4.5V)$ | $R_{ds(on)} < 135m\Omega (V_{gs}=-4.5V)$ |

### ■ Maximum Absolute Ratings

Parameter	Symbol	N-ch (Max.)	P-ch (Max.)	Unit	Note
Drain-source voltage	$V_{ds}$	60	-60	V	
Gate-source voltage	$V_{gs}$	$\pm 20$	$\pm 20$	V	
Continuous drain current	$I_d$	$T_a=25^\circ C$	4.5	-3.5	A
		$T_a=70^\circ C$	4.0	-3.0	
Pulsed drain current	$I_{dm}$	20	-20	A	3
Power dissipation	$P_d$	$T_a=25^\circ C$	2.0	2.0	W
		$T_a=70^\circ C$	1.3	1.3	
Junction and storage temperature range	$T_j, T_{stg}$	-55 to 150	-55 to 150	$^\circ C$	

### ■ Thermal Characteristics

Parameter	Symbol	Device	Typ.	Max.	Unit	Note
Maximum junction-to-ambient	$R_{\theta ja}$	N-ch		62.5	$^\circ C/W$	
Maximum junction-to-ambient	$R_{\theta ja}$	P-ch		62.5	$^\circ C/W$	

### ■ Pin configuration

SOP-8(TOP VIEW)

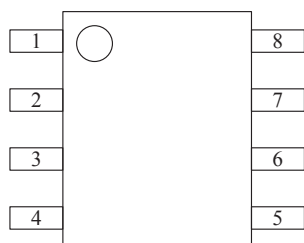

Pin No.	Pin name
1	SOURCE1
2	GATE1
3	SOURCE2
4	GATE2
5	DRAIN2
6	DRAIN2
7	DRAIN1
8	DRAIN1

### ■ Circuit

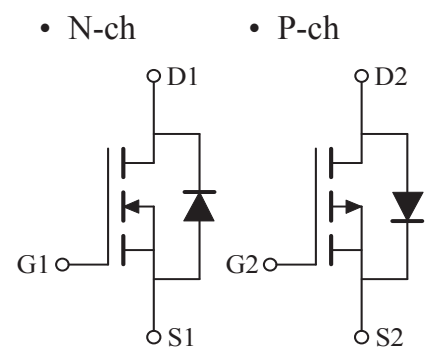

# Complementary MOSFET

## ELM34608AA-N

### ■Electrical Characteristics (N-ch)

Ta=25°C

Parameter	Symbol	Conditions	Min.	Typ.	Max.	Unit	Note
<b>STATIC PARAMETERS</b>							
Drain-source breakdown voltage	BVdss	Id=250μA, Vgs=0V	60			V	
Zero gate voltage drain current	Idss	Vds=48V, Vgs=0V			1	μA	
		Vds=40V, Vgs=0V, Tj=55°C			10		
Gate-body leakage current	Igss	Vds=0V, Vgs=±20V			±100	nA	
Gate threshold voltage	Vgs(th)	Vds=Vgs, Id=250μA	1.0	1.5	2.5	V	
On state drain current	Id(on)	Vgs=10V, Vds=5V	20			A	1
Static drain-source on-resistance	Rds(on)	Vgs=10V, Id=4.5A		42	58	mΩ	1
		Vgs=4.5V, Id=4A		55	85		
Forward transconductance	Gfs	Vds=10V, Id=4.5A		14		S	1
Diode forward voltage	Vsd	If=Is=1.3A, Vgs=0V			1	V	1
Max.body-diode continuous current	Is				1.3	A	
Pulsed current	Ism				2.6	A	3
<b>DYNAMIC PARAMETERS</b>							
Input capacitance	Ciss	Vgs=0V, Vds=25V, f=1MHz		650		pF	
Output capacitance	Coss			80		pF	
Reverse transfer capacitance	Crss			35		pF	
<b>SWITCHING PARAMETERS</b>							
Total gate charge	Qg	Vgs=10V, Vds=30V, Id=4.5A		12.0	16.0	nC	2
Gate-source charge	Qgs			2.4		nC	2
Gate-drain charge	Qgd			2.6		nC	2
Turn-on delay time	td(on)	Vgs=10V, Vds=30V, Id≈1A Rgen=6Ω		11	20	ns	2
Turn-on rise time	tr			8	18	ns	2
Turn-off delay time	td(off)			19	35	ns	2
Turn-off fall time	tf			6	15	ns	2

NOTE :

1. Pulse test : Pulsed width≤300μsec and Duty cycle≤2%.
2. Independent of operating temperature.
3. Pulsed width limited by maximum junction temperature.
4. Duty cycle ≤ 1%.

# Complementary MOSFET

## ELM34608AA-N

### ■ Typical Electrical and Thermal Characteristics (N-ch)

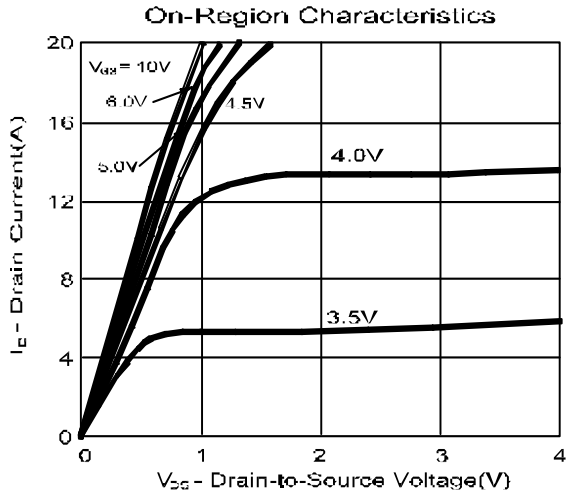

On-Resistance Variation with Drain Current and Gate Voltage

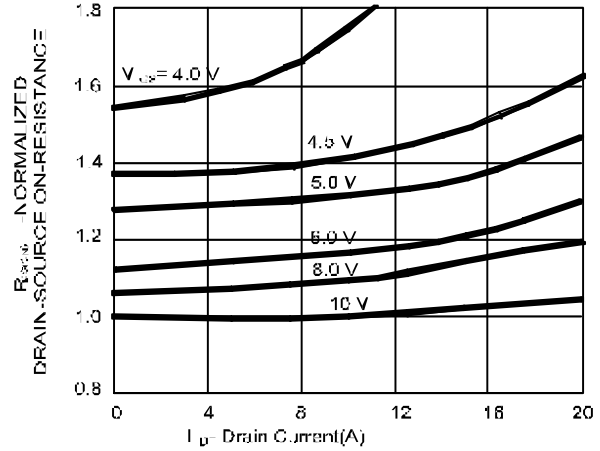

On-Resistance Variation with Temperature

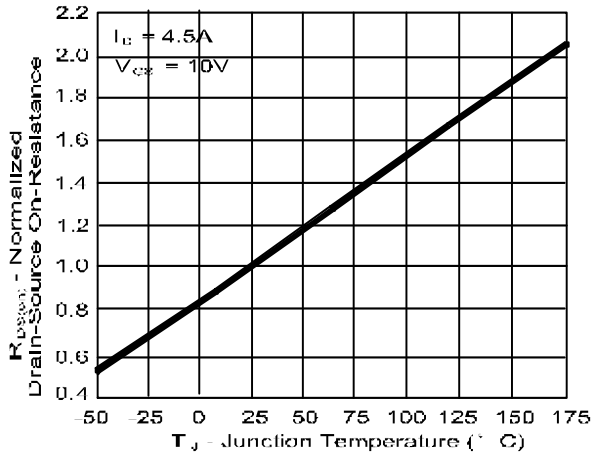

On-Resistance Variation with Gate-to-Source Voltage

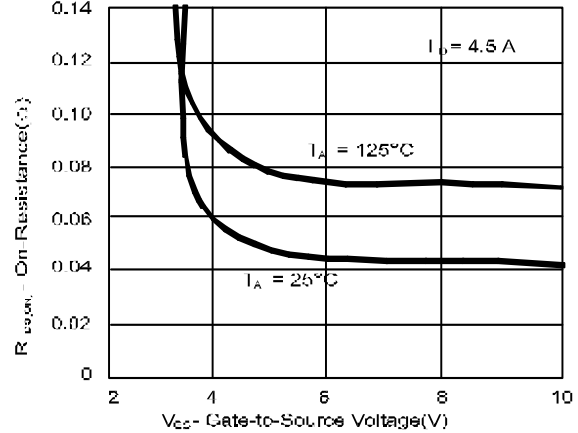

Transfer Characteristics

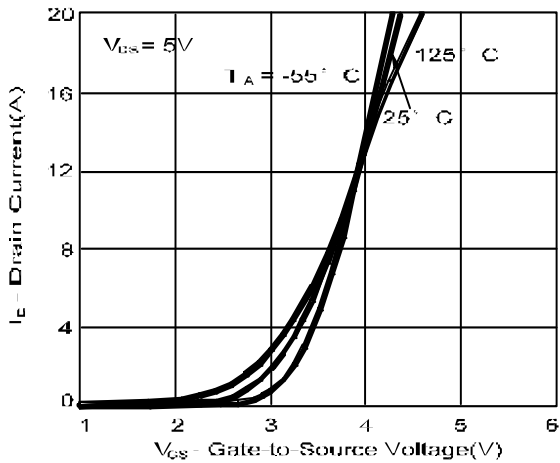

Body Diode Forward Voltage Variation with Source Current and Temperature

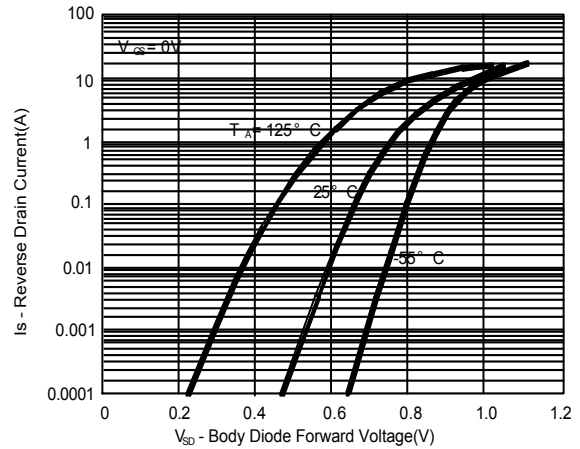

# Complementary MOSFET

## ELM34608AA-N

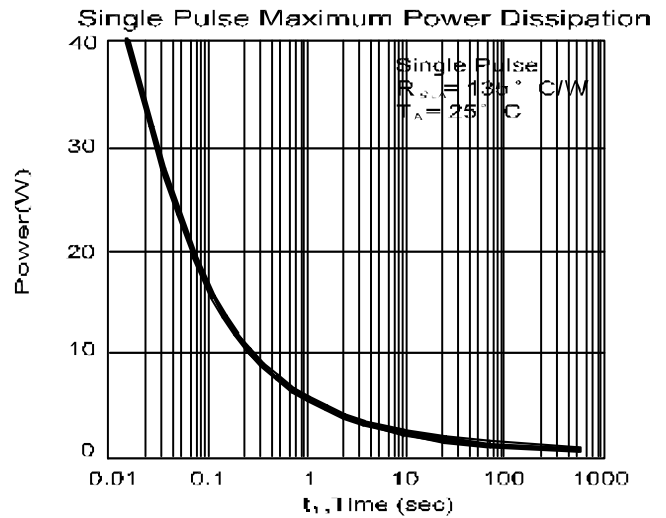
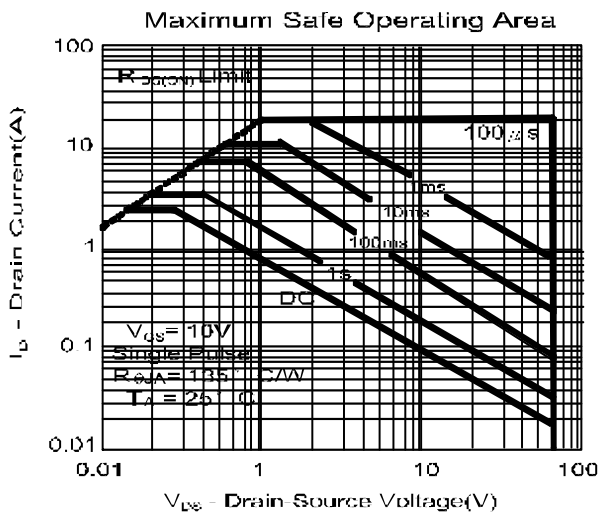
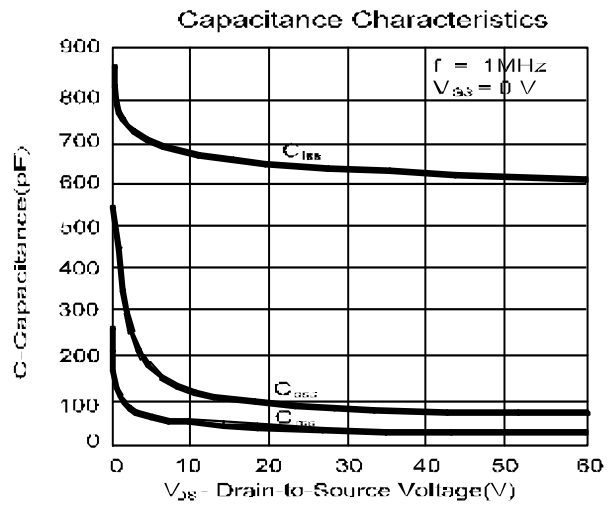
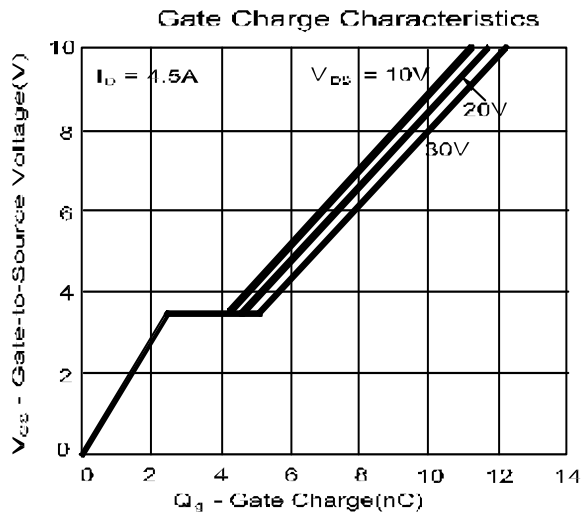

# Complementary MOSFET

## ELM34608AA-N

### ■Electrical Characteristics (P-ch)

Ta=25°C

Parameter	Symbol	Conditions	Min.	Typ.	Max.	Unit	Note
<b>STATIC PARAMETERS</b>							
Drain-source breakdown voltage	BVdss	Id=-250μA, Vgs=0V	-60			V	
Zero gate voltage drain current	Idss	Vds=-48V, Vgs=0V			-1	μA	
		Vds=-40V, Vgs=0V, Tj=55°C			-10		
Gate-body leakage current	Igss	Vds=0V, Vgs=±20V			±100	nA	
Gate threshold voltage	Vgs(th)	Vds=Vgs, Id=-250μA	-1.0	-1.5	-2.5	V	
On state drain current	Id(on)	Vgs=-10V, Vds=-5V	-20			A	1
Static drain-source on-resistance	Rds(on)	Vgs=-10V, Id=-3.5A		70	90	mΩ	1
		Vgs=-4.5V, Id=-3A		100	135		
Forward transconductance	Gfs	Vds=-5V, Id=-3.5A		9		S	1
Diode forward voltage	Vsd	If=Is=-1.3A, Vgs=0V			-1	V	1
Max.body-diode continuous current	Is				-1.3	A	
Pulsed current	Ism				-2.6	A	3
<b>DYNAMIC PARAMETERS</b>							
Input capacitance	Ciss	Vgs=0V, Vds=-30V, f=1MHz		630		pF	
Output capacitance	Coss			81		pF	
Reverse transfer capacitance	Crss			33		pF	
<b>SWITCHING PARAMETERS</b>							
Total gate charge	Qg	Vgs=-10V, Vds=-30V Id=-3.5A		11.0	15.0	nC	2
Gate-source charge	Qgs			2.1		nC	2
Gate-drain charge	Qgd			2.5		nC	2
Turn-on delay time	td(on)	Vgs=-10V, Vds=-30V Id≈-1A, Rgen=6Ω		6	13	ns	2
Turn-on rise time	tr			8	18	ns	2
Turn-off delay time	td(off)			17	31	ns	2
Turn-off fall time	tf			11	20	ns	2

NOTE :

1. Pulse test : Pulsed width≤300μsec and Duty cycle≤2%.
2. Independent of operating temperature.
3. Pulsed width limited by maximum junction temperature.

# Complementary MOSFET

## ELM34608AA-N

### ■ Typical Electrical and Thermal Characteristics (P-ch)

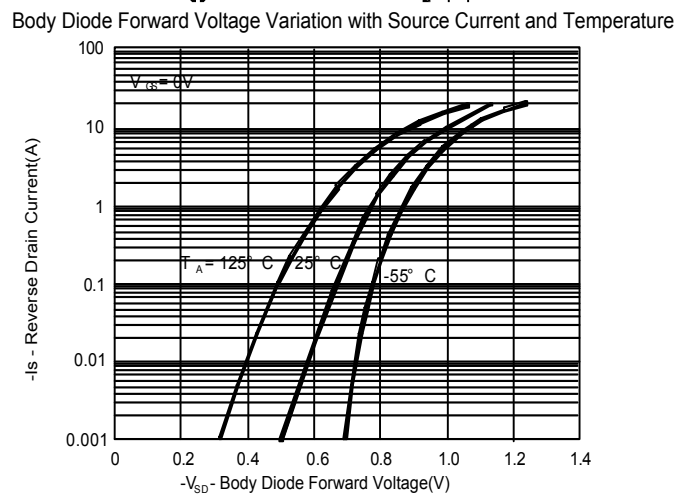
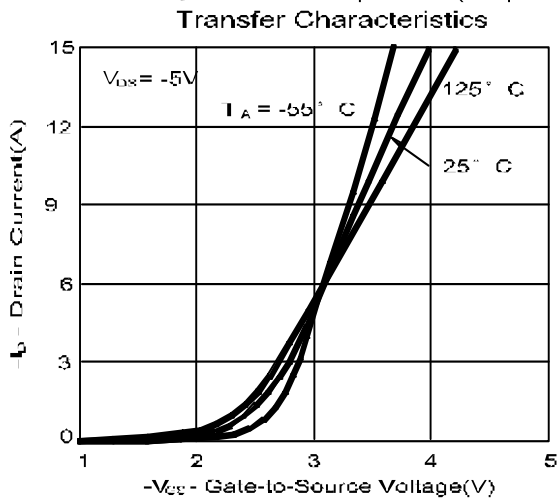
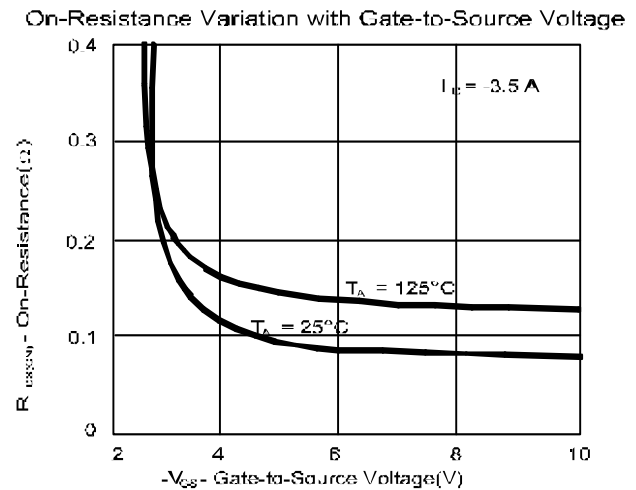
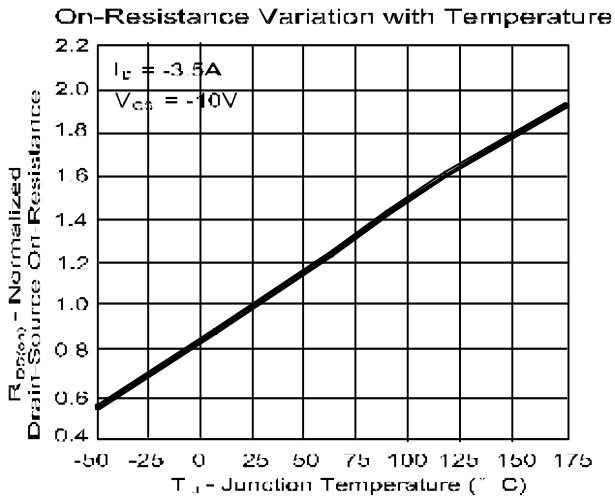
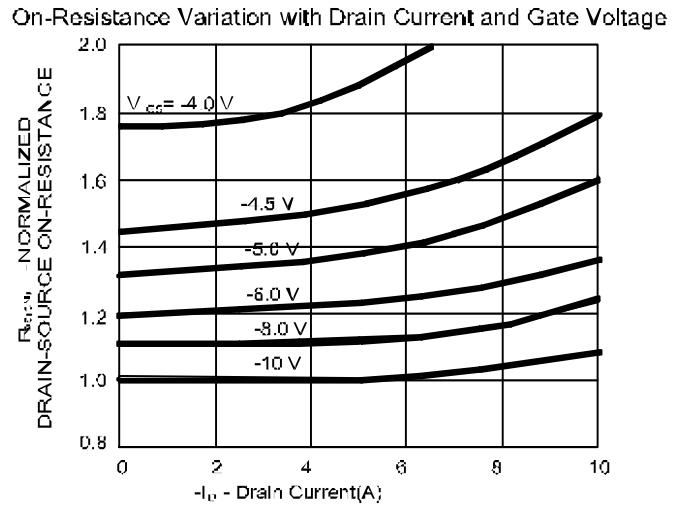
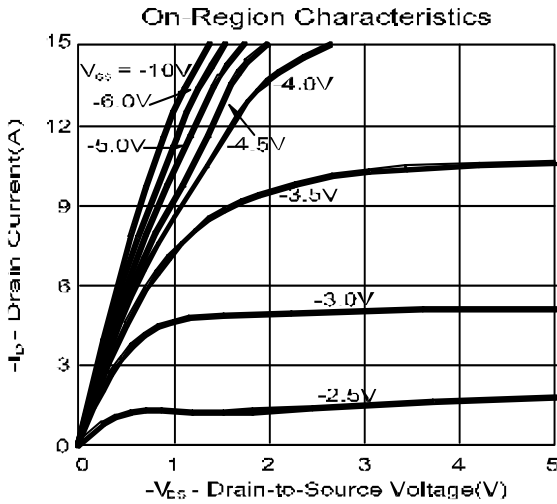

# Complementary MOSFET

## ELM34608AA-N

