

# Complementary MOSFET

## ELM34603AA-N

### ■ General Description

ELM34603AA-N uses advanced trench technology to provide excellent  $R_{ds(on)}$  and low gate charge.

### ■ Features

- |   |   |
|---|---|
| N-channel                                 | P-channel                               |
| • $V_{ds}=30V$                            | $V_{ds}=-30V$                           |
| • $I_d=7A$                                | $I_d=-6A$                               |
| • $R_{ds(on)} < 27.5m\Omega (V_{gs}=10V)$ | $R_{ds(on)} < 34m\Omega (V_{gs}=-10V)$  |
| • $R_{ds(on)} < 40m\Omega (V_{gs}=4.5V)$  | $R_{ds(on)} < 56m\Omega (V_{gs}=-4.5V)$ |

### ■ Maximum Absolute Ratings

Parameter	Symbol	N-ch (Max.)	P-ch (Max.)	Unit	Note
Drain-source voltage	$V_{ds}$	30	-30	V	
Gate-source voltage	$V_{gs}$	$\pm 20$	$\pm 20$	V	
Continuous drain current	$I_d$	$T_a=25^\circ C$	7	-6	A
		$T_a=70^\circ C$	6	-5	
Pulsed drain current	$I_{dm}$	20	-20	A	3
Power dissipation	$P_d$	$T_a=25^\circ C$	2.0	2.0	W
		$T_a=70^\circ C$	1.3	1.3	
Junction and storage temperature range	$T_j, T_{stg}$	-55 to 150	-55 to 150	$^\circ C$	

### ■ Thermal Characteristics

Parameter	Symbol	Device	Typ.	Max.	Unit	Note
Maximum junction-to-ambient	$R_{\theta ja}$	N-ch		62.5	$^\circ C/W$	
Maximum junction-to-ambient	$R_{\theta ja}$	P-ch		62.5	$^\circ C/W$	

### ■ Pin configuration

SOP-8(TOP VIEW)

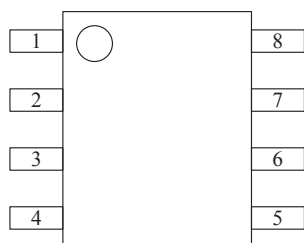

Pin No.	Pin name
1	SOURCE1
2	GATE1
3	SOURCE2
4	GATE2
5	DRAIN2
6	DRAIN2
7	DRAIN1
8	DRAIN1

### ■ Circuit

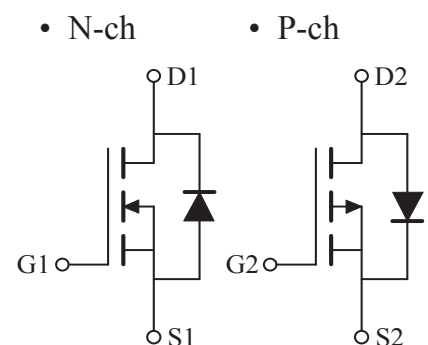

# Complementary MOSFET

## ELM34603AA-N

### ■Electrical Characteristics (N-ch)

Ta=25°C

Parameter	Symbol	Conditions	Min.	Typ.	Max.	Unit	Note
<b>STATIC PARAMETERS</b>							
Drain-source breakdown voltage	BVdss	Id=250μA, Vgs=0V	30			V	
Zero gate voltage drain current	Idss	Vds=24V, Vgs=0V			1	μA	
		Vds=20V, Vgs=0V, Tj=55°C			10		
Gate-body leakage current	Igss	Vds=0V, Vgs=±20V			±100	nA	
Gate threshold voltage	Vgs(th)	Vds=Vgs, Id=250μA	1.0	1.5	2.5	V	
On state drain current	Id(on)	Vgs=10V, Vds=5V	20			A	1
Static drain-source on-resistance	Rds(on)	Vgs=10V, Id=7A		20.5	27.5	mΩ	1
		Vgs=4.5V, Id=6A		30.0	40.0		
Forward transconductance	Gfs	Vds=5V, Id=7A		16		S	1
Diode forward voltage	Vsd	If=1A, Vgs=0V			1	V	1
Max.body-diode continuous current	Is				1.3	A	
Pulsed current	Ism				2.6	A	3
<b>DYNAMIC PARAMETERS</b>							
Input capacitance	Ciss	Vgs=0V, Vds=15V, f=1MHz		680		pF	
Output capacitance	Coss			105		pF	
Reverse transfer capacitance	Crss			75		pF	
<b>SWITCHING PARAMETERS</b>							
Total gate charge	Qg	Vgs=10V, Vds=15V, Id=7A		14.0		nC	2
Gate-source charge	Qgs			1.9		nC	2
Gate-drain charge	Qgd			3.3		nC	2
Turn-on delay time	td(on)	Vgs=10V, Vds=10V, Id≈1A Rgen=3Ω		4.6	7.0	ns	2
Turn-on rise time	tr			4.0	6.0	ns	2
Turn-off delay time	td(off)			20.0	30.0	ns	2
Turn-off fall time	tf			5.0	8.0	ns	2

NOTE :

1. Pulse test : Pulsed width≤300μsec and Duty cycle≤2%.
2. Independent of operating temperature.
3. Pulsed width limited by maximum junction temperature.
4. Duty cycle ≤ 1%.

# Complementary MOSFET

## ELM34603AA-N

### ■ Typical Electrical and Thermal Characteristics (N-ch)

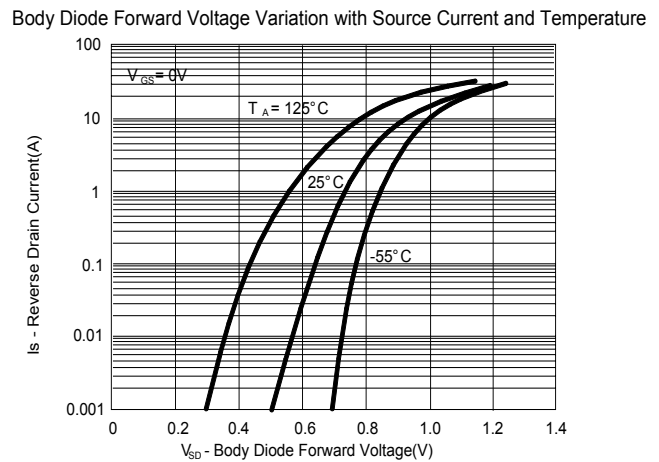
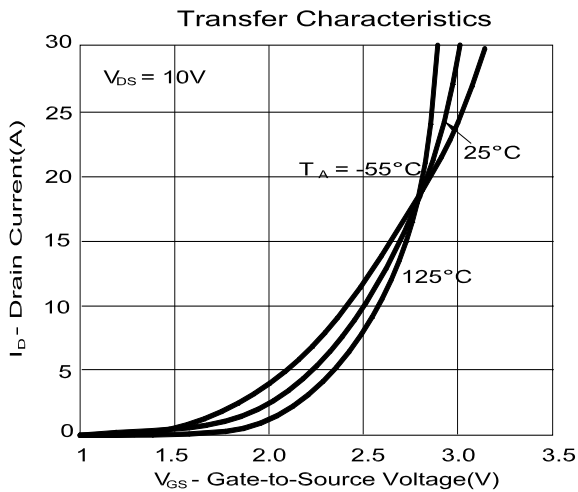
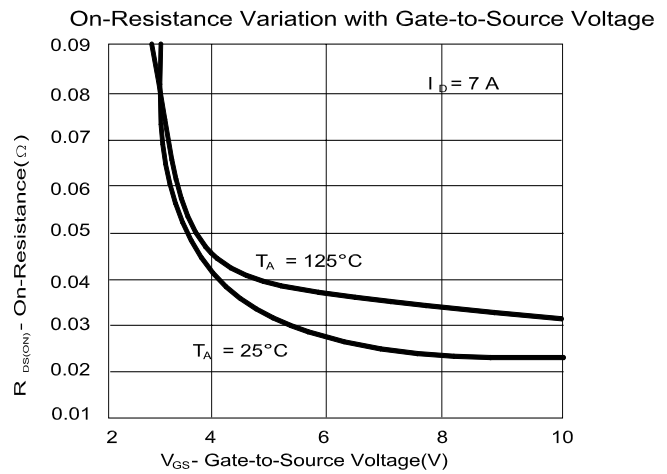
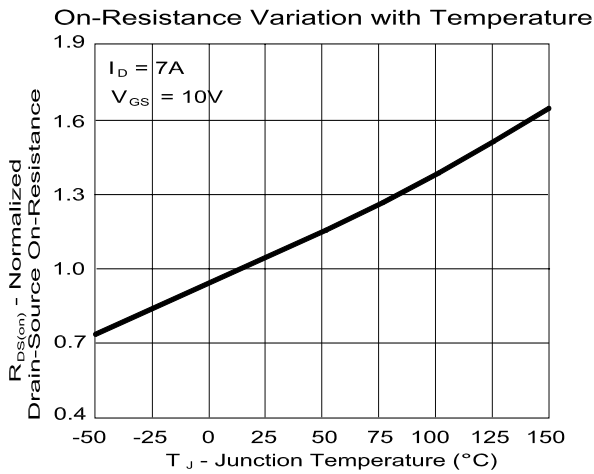
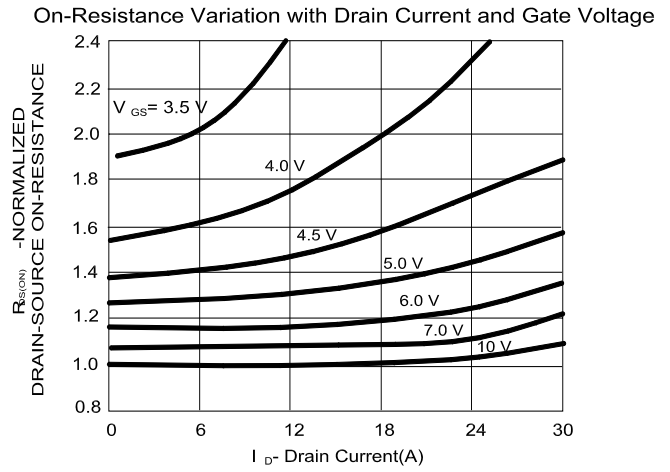
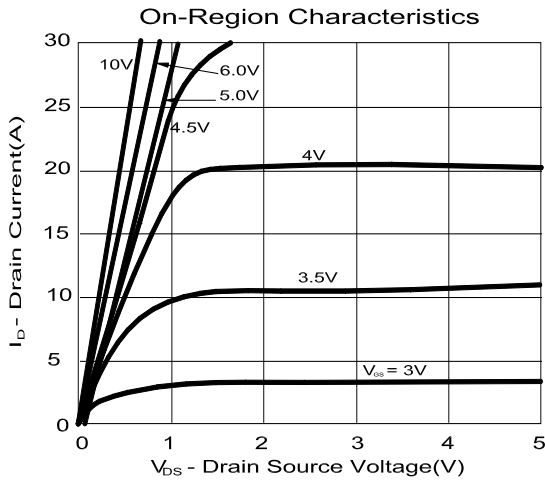

# Complementary MOSFET

## ELM34603AA-N

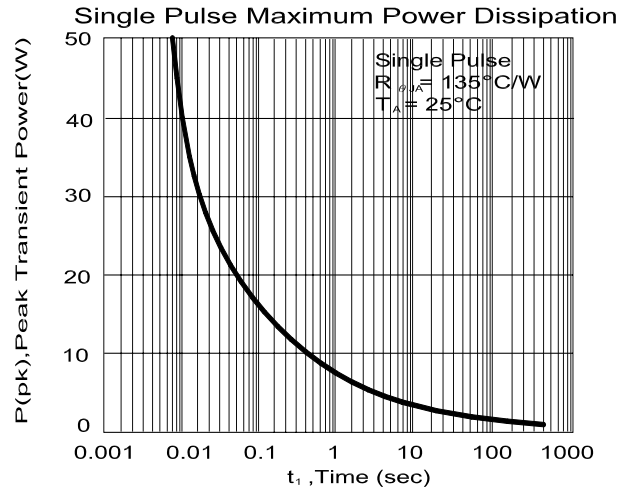
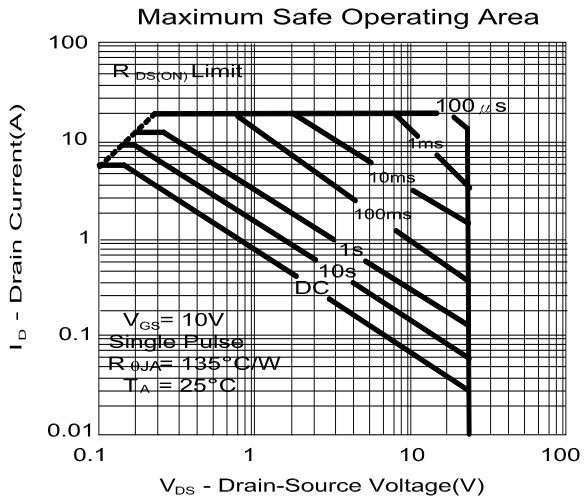
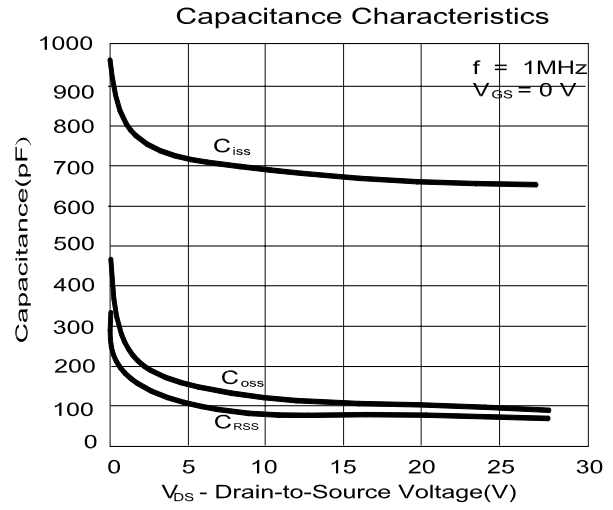
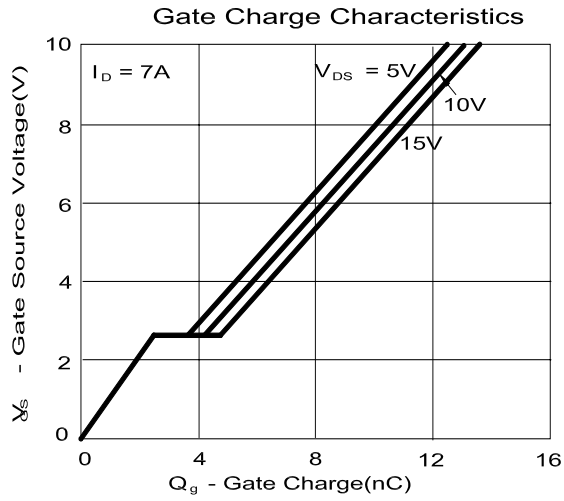

# Complementary MOSFET

## ELM34603AA-N

### ■Electrical Characteristics (P-ch)

Ta=25°C

Parameter	Symbol	Conditions	Min.	Typ.	Max.	Unit	Note
<b>STATIC PARAMETERS</b>							
Drain-source breakdown voltage	BVdss	Id=-250μA, Vgs=0V	-30			V	
Zero gate voltage drain current	Idss	Vds=-24V, Vgs=0V			-1	μA	
		Vds=-20V, Vgs=0V, Tj=55°C			-10		
Gate-body leakage current	Igss	Vds=0V, Vgs=±20V			±100	nA	
Gate threshold voltage	Vgs(th)	Vds=Vgs, Id=-250μA	-1.0	-1.5	-2.5	V	
On state drain current	Id(on)	Vgs=-10V, Vds=-5V	-20			A	1
Static drain-source on-resistance	Rds(on)	Vgs=-10V, Id=-6A		27.5	34.0	mΩ	1
		Vgs=-4.5V, Id=-5A		43.5	56.0		
Forward transconductance	Gfs	Vds=-5V, Id=-6A		13		S	1
Diode forward voltage	Vsd	If=-1A, Vgs=0V			-1	V	1
Max.body-diode continuous current	Is				-1.3	A	
Pulsed current	Ism				-2.6	A	3
<b>DYNAMIC PARAMETERS</b>							
Input capacitance	Ciss	Vgs=0V, Vds=-15V, f=1MHz		920		pF	
Output capacitance	Coss			190		pF	
Reverse transfer capacitance	Crss			120		pF	
<b>SWITCHING PARAMETERS</b>							
Total gate charge	Qg	Vgs=-10V, Vds=-15V Id=-6A		18.5		nC	2
Gate-source charge	Qgs			2.7		nC	2
Gate-drain charge	Qgd			4.5		nC	2
Turn-on delay time	td(on)	Vgs=-10V, Vds=-10V Id≈-1A, Rgen=3Ω		7.7	11.5	ns	2
Turn-on rise time	tr			5.7	8.5	ns	2
Turn-off delay time	td(off)			20.0	30.0	ns	2
Turn-off fall time	tf			9.5	14.0	ns	2

NOTE :

1. Pulse test : Pulsed width≤300μsec and Duty cycle≤2%.
2. Independent of operating temperature.
3. Pulsed width limited by maximum junction temperature.

# Complementary MOSFET

## ELM34603AA-N

### ■ Typical Electrical and Thermal Characteristics (P-ch)

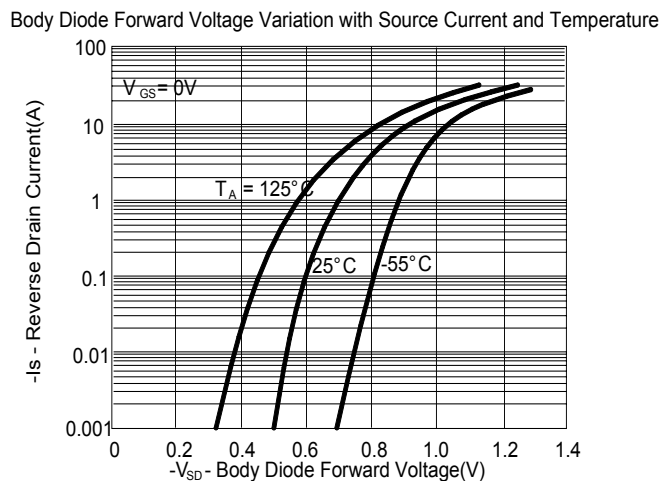
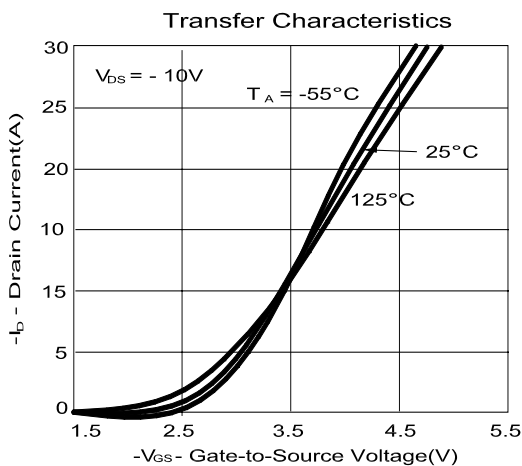
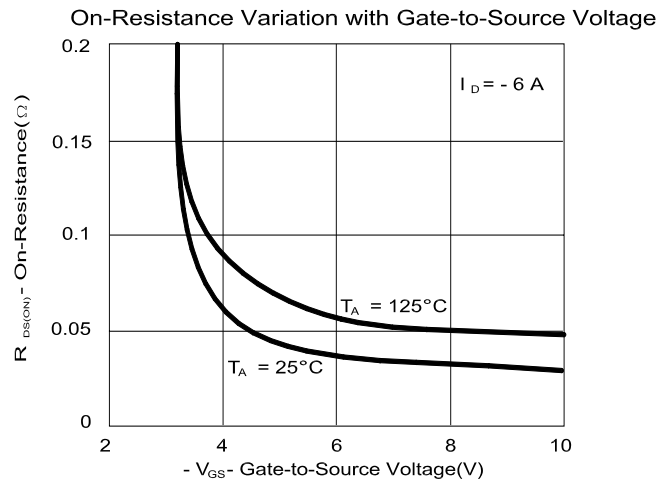
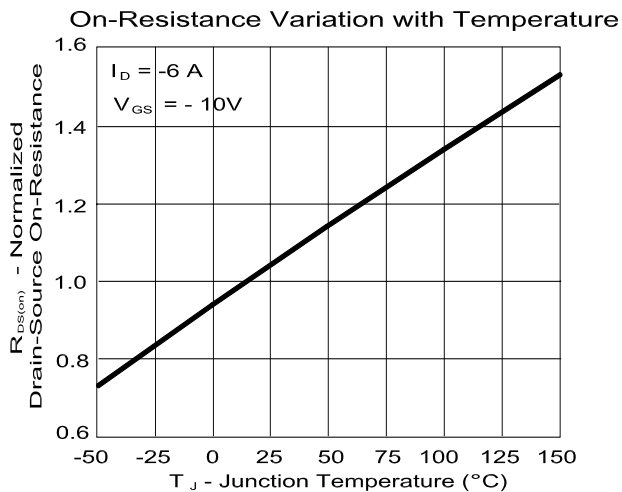
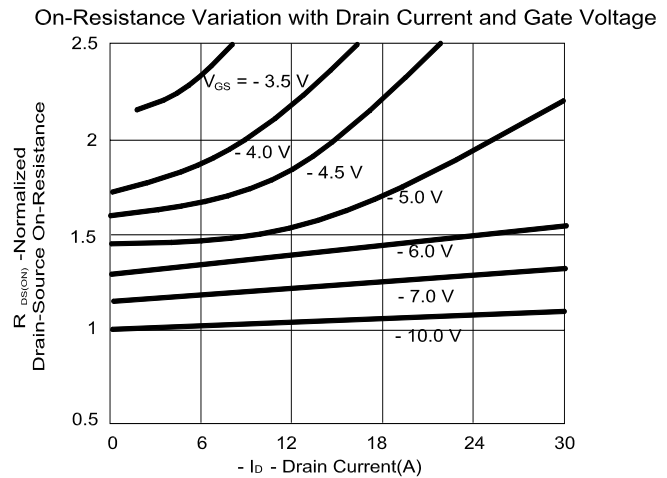
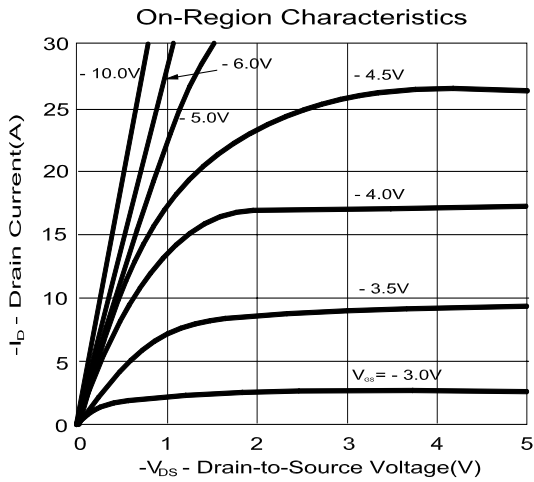

# Complementary MOSFET

## ELM34603AA-N

