

# Dual N-channel MOSFET

## ELM34804AA-N

### ■ General description

ELM34804AA-N uses advanced trench technology to provide excellent  $R_{ds(on)}$ , low gate charge and low gate resistance.

### ■ Features

- $V_{ds}=60V$
- $I_d=4.5A$
- $R_{ds(on)} < 55m\Omega$  ( $V_{gs}=10V$ )
- $R_{ds(on)} < 75m\Omega$  ( $V_{gs}=4.5V$ )

### ■ Maximum absolute ratings

Parameter	Symbol	Limit	Unit	Note
Drain-source voltage	$V_{ds}$	60	V	
Gate-source voltage	$V_{gs}$	$\pm 20$	V	
Continuous drain current	$I_d$	Ta=25°C	4.5	A
		Ta=70°C	4.0	
Pulsed drain current	$I_{dm}$	20	A	3
Power dissipation	$P_d$	Ta=25°C	2.0	W
		Ta=70°C	1.3	
Junction and storage temperature range	$T_j, T_{stg}$	-55 to 150	°C	

### ■ Thermal characteristics

Parameter		Symbol	Typ.	Max.	Unit	Note
Maximum junction-to-ambient	Steady-state	$R_{\theta ja}$		62.5	°C/W	

### ■ Pin configuration

SOP-8(TOP VIEW)

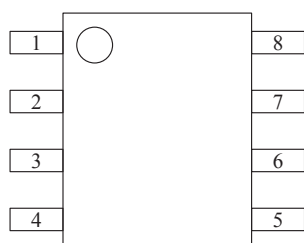

Pin No.	Pin name
1	SOURCE1
2	GATE1
3	SOURCE2
4	GATE2
5	DRAIN2
6	DRAIN2
7	DRAIN1
8	DRAIN1

### ■ Circuit

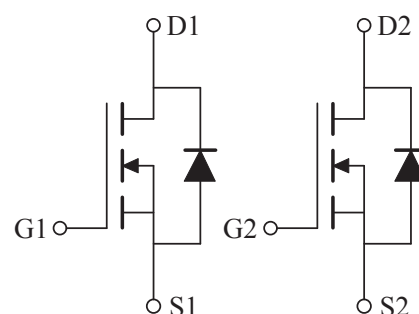

# Dual N-channel MOSFET

## ELM34804AA-N

### ■Electrical characteristics

Ta=25°C

Parameter	Symbol	Condition	Min.	Typ.	Max.	Unit	Note
<b>STATIC PARAMETERS</b>							
Drain-source breakdown voltage	BVdss	Id=250μA, Vgs=0V	60			V	
Zero gate voltage drain current	Idss	Vds=48V, Vgs=0V			1	μA	
		Vds=40V, Vgs=0V, Tj=55°C			10		
Gate-body leakage current	Igss	Vds=0V, Vgs=±20V			±100	nA	
Gate threshold voltage	Vgs(th)	Vds=Vgs, Id=250μA	1.0	1.5	2.5	V	
On state drain current	Id(on)	Vgs=10V, Vds=5V	20			A	1
Static drain-source on-resistance	Rds(on)	Vgs=10V, Id=4.5A		42	55	mΩ	1
		Vgs=4.5V, Id=4A		55	75	mΩ	
Forward transconductance	Gfs	Vds=10V, Id=4.5A		14		S	1
Diode forward voltage	Vsd	If=Is, Vgs=0V			1	V	1
Max.body-diode continuous current	Is				1.3	A	
Pulsed current	Ism				2.6	A	3
<b>DYNAMIC PARAMETERS</b>							
Input capacitance	Ciss	Vgs=0V, Vds=25V, f=1MHz		650		pF	
Output capacitance	Coss			80		pF	
Reverse transfer capacitance	Crss			35		pF	
<b>SWITCHING PARAMETERS</b>							
Total gate charge	Qg	Vgs=10V, Vds=30V, Id=4.5A		12.5	18.0	nC	2
Gate-source charge	Qgs			2.4		nC	2
Gate-drain charge	Qgd			2.6		nC	2
Turn-on delay time	td(on)	Vgs=10V, Vds=30V, Id≈1A Rgen=6Ω		11	20	ns	2
Turn-on rise time	tr			8	18	ns	2
Turn-off delay time	td(off)			19	35	ns	2
Turn-off fall time	tf			6	15	ns	2

NOTE :

1. Pulsed width ≤ 300μsec and Duty cycle ≤ 2%.
2. Independent of operating temperature.
3. Pulsed width limited by maximum junction temperature.
4. Duty cycle ≤ 1%.

# Dual N-channel MOSFET

## ELM34804AA-N

### ■ Typical electrical and thermal characteristics

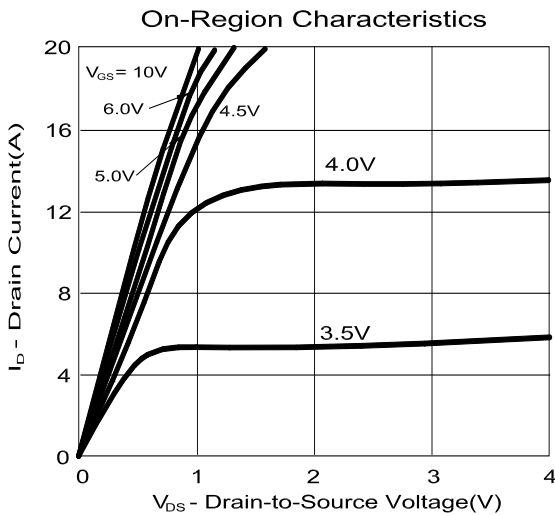

On-Resistance Variation with Drain Current and Gate Voltage

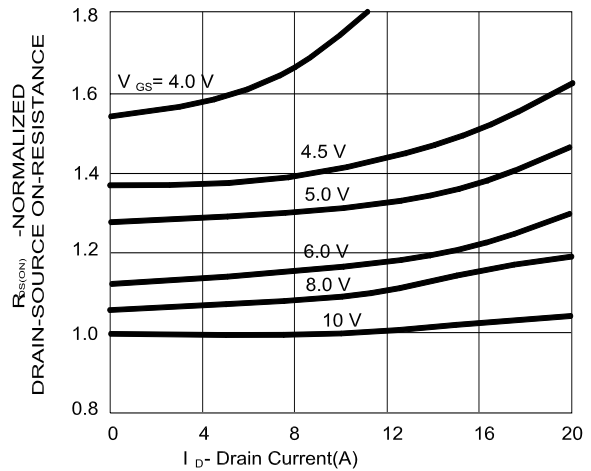

On-Resistance Variation with Temperature

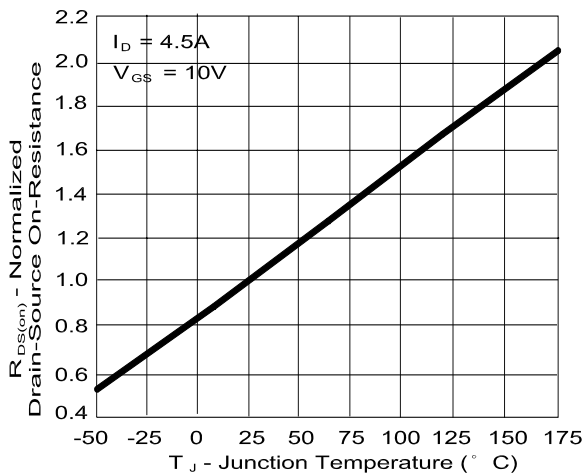

On-Resistance Variation with Gate-to-Source Voltage

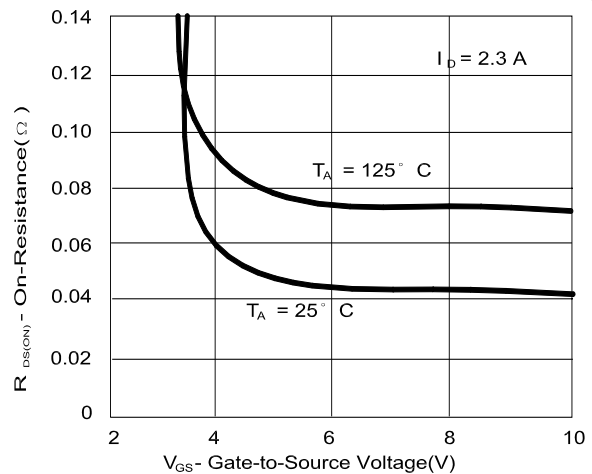

Transfer Characteristics

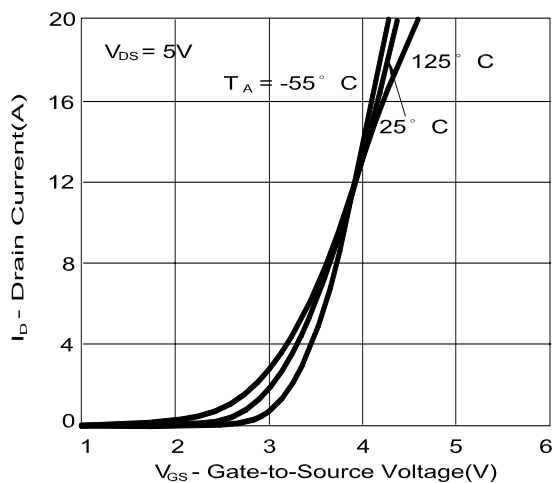

Body Diode Forward Voltage Variation with Source Current and Temperature

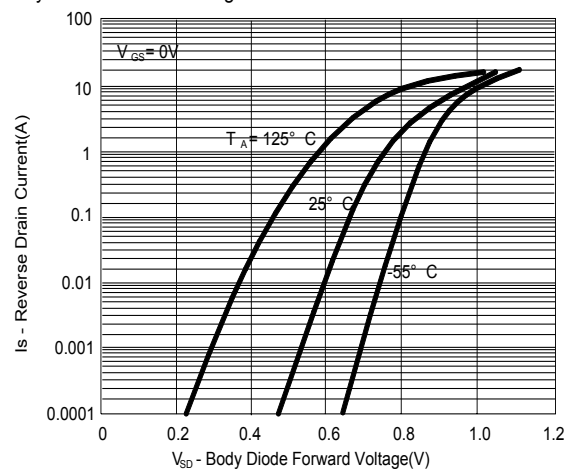

# Dual N-channel MOSFET

## ELM34804AA-N

