

Dual N-channel MOSFET

ELM14812AA-N

■ General description

ELM14812AA-N uses advanced trench technology to provide excellent $R_{ds(on)}$ and low gate charge.

■ Features

- $V_{ds}=30V$
- $I_d=6.9A$ ($V_{gs}=10V$)
- $R_{ds(on)} < 28m\Omega$ ($V_{gs}=10V$)
- $R_{ds(on)} < 42m\Omega$ ($V_{gs}=4.5V$)

■ Maximum absolute ratings

Parameter	Symbol	Limit	Unit	Note	
Drain-source voltage	V_{ds}	30	V		
Gate-source voltage	V_{gs}	± 20	V		
Continuous drain current	I_d	$T_a=25^\circ C$	6.9	A	1
		$T_a=70^\circ C$	5.8		
Pulsed drain current	I_{dm}	30	A	2	
Power dissipation	P_d	$T_a=25^\circ C$	2.00	W	
		$T_a=70^\circ C$	1.44		
Junction and storage temperature range	T_j, T_{stg}	-55 to 150	$^\circ C$		

■ Thermal characteristics

Parameter		Symbol	Typ.	Max.	Unit	Note
Maximum junction-to-ambient	$t \leq 10s$	$R_{\theta ja}$	48.0	62.5	$^\circ C/W$	1
Maximum junction-to-ambient	Steady-state		74.0	110.0	$^\circ C/W$	
Maximum junction-to-lead	Steady-state	$R_{\theta jl}$	35.0	40.0	$^\circ C/W$	3

■ Pin configuration

SOP-8(TOP VIEW)

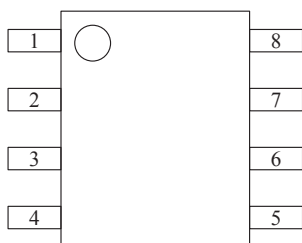

Pin No.	Pin name
1	SOURCE2
2	GATE2
3	SOURCE1
4	GATE1
5	DRAIN1
6	DRAIN1
7	DRAIN2
8	DRAIN2

■ Circuit

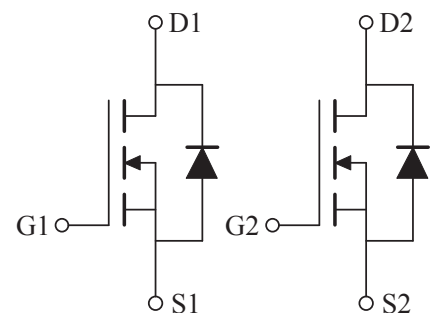

Dual N-channel MOSFET

ELM14812AA-N

■ Electrical characteristics

Ta=25°C

Parameter	Symbol	Condition	Min.	Typ.	Max.	Unit
STATIC PARAMETERS						
Drain-source breakdown voltage	BVdss	Id=250μA, Vgs=0V	30			V
Zero gate voltage drain current	Idss	Vds=24V, Vgs=0V		0.004	1.000	μA
		Tj=55°C			5.000	
Gate-body leakage current	Igss	Vds=0V, Vgs=±20V			100	nA
Gate threshold voltage	Vgs(th)	Vds=Vgs, Id=250μA	1.0	1.9	3.0	V
On state drain current	Id(on)	Vgs=4.5V, Vds=5V	20			A
Static drain-source on-resistance	Rds(on)	Vgs=10V, Id=6.9A		22.5	28.0	mΩ
		Tj=125°C		31.3	38.0	
		Vgs=4.5V, Id=5A		34.5	42.0	mΩ
Forward transconductance	Gfs	Vds=5V, Id=6.9A	10.0	15.4		S
Diode forward voltage	Vsd	Is=1A		0.76	1.00	V
Max. body-diode continuous current	Is				3	A
DYNAMIC PARAMETERS						
Input capacitance	Ciss			680	820	pF
Output capacitance	Coss	Vgs=0V, Vds=15V, f=1MHz		102		pF
Reverse transfer capacitance	Crss			77		pF
Gate resistance	Rg	Vgs=0V, Vds=0V, f=1MHz		3.0	3.6	Ω
SWITCHING PARAMETERS						
Total gate charge (10V)	Qg	Vgs=10V, Vds=15V, Id=6.9A		13.84	17.00	nC
Total gate charge (4.5V)	Qg			6.74	8.10	nC
Gate-source charge	Qgs			1.82		nC
Gate-drain charge	Qgd			3.20		nC
Turn-on delay time	td(on)	Vgs=10V, Vds=15V		4.6	7.0	ns
Turn-on rise time	tr			4.1	6.2	ns
Turn-off delay time	td(off)		RI=2.2Ω, Rgen=3Ω		20.6	30.0
Turn-off fall time	tf			5.2	7.5	ns
Body diode reverse recovery time	trr	If=6.9A, dl/dt=100A/μs		16.5	20.0	ns
Body diode reverse recovery charge	Qrr	If=6.9A, dl/dt=100A/μs		7.8	10.0	nC

NOTE :

1. The value of Rθja is measured with the device mounted on 1in² FR-4 board of 2oz. Copper, in still air environment with Ta=25°C. The value in any given applications depends on the user's specific board design, The current rating is based on the t ≤ 10s thermal resistance rating.
2. Repetitive rating, pulse width limited by junction temperature.
3. The Rθja is the sum of the thermal impedance from junction to lead Rθjl and lead to ambient.
4. The static characteristics in Figures 1 to 6 are obtained using 80μs pulses, duty cycle 0.5%max.
5. These tests are performed with the device mounted on 1in² FR-4 board with 2oz. Copper, in a still air environment with Ta=25°C. The SOA curve provides a single pulse rating.

Dual N-channel MOSFET

ELM14812AA-N

■ Typical electrical and thermal characteristics

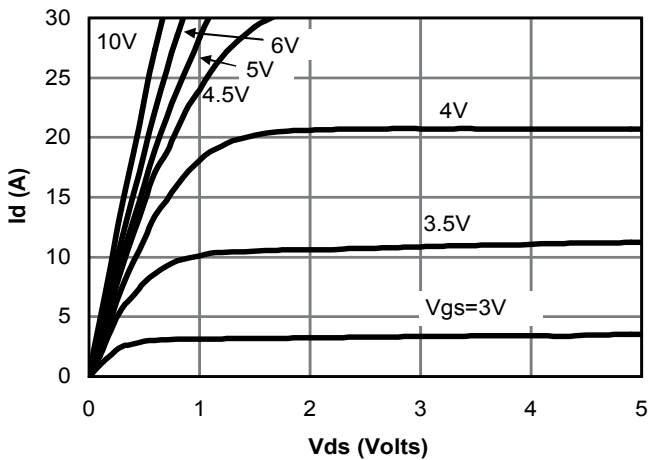

Fig 1: On-Region Characteristics

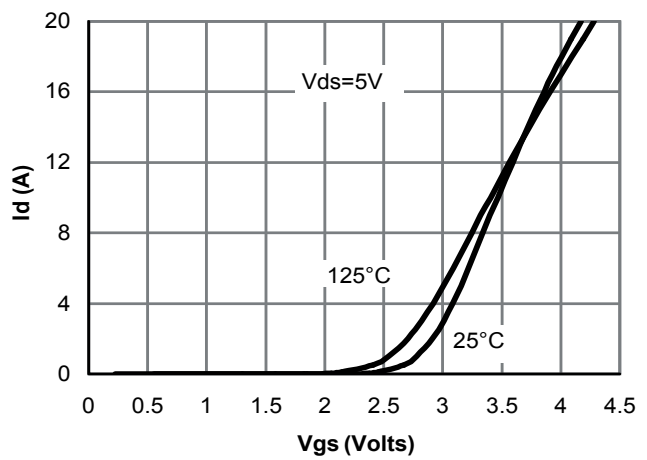

Figure 2: Transfer Characteristics

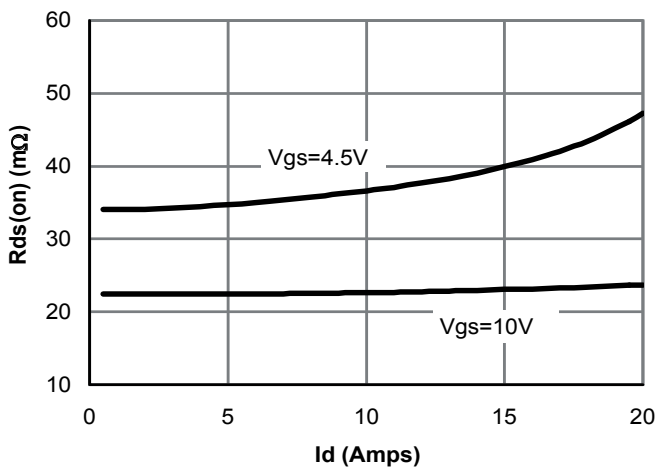

Figure 3: On-Resistance vs. Drain Current and Gate Voltage

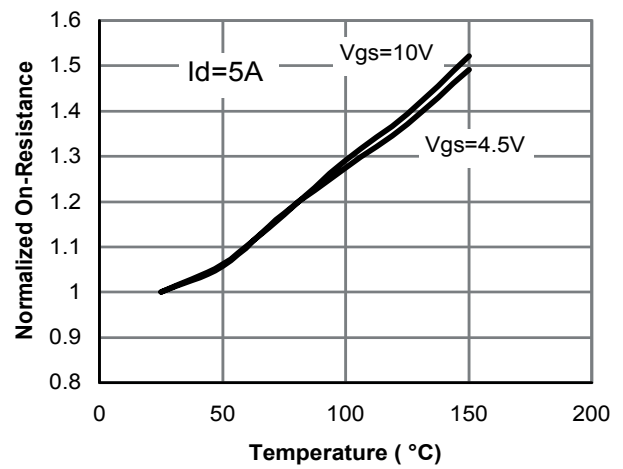

Figure 4: On-Resistance vs. Junction Temperature

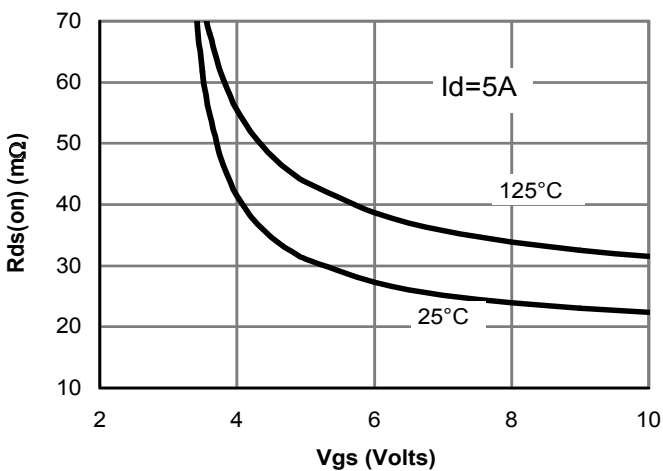

Figure 5: On-Resistance vs. Gate-Source Voltage

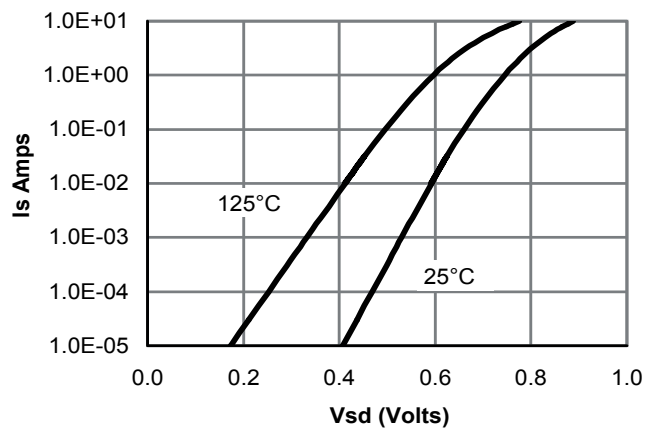

Figure 6: Body diode characteristics

Dual N-channel MOSFET

ELM14812AA-N

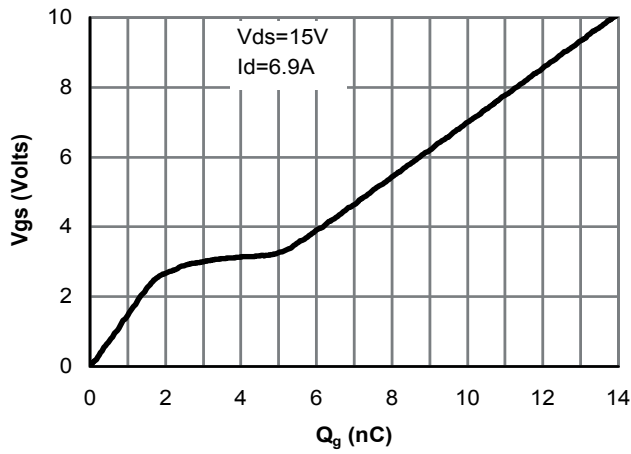

Figure 7: Gate-Charge characteristics

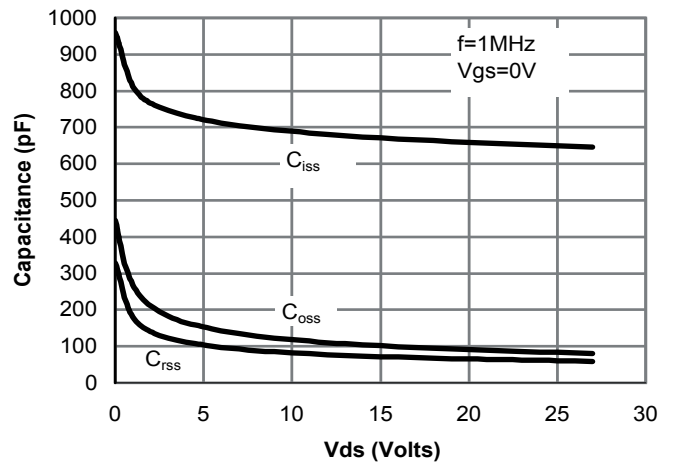

Figure 8: Capacitance Characteristics

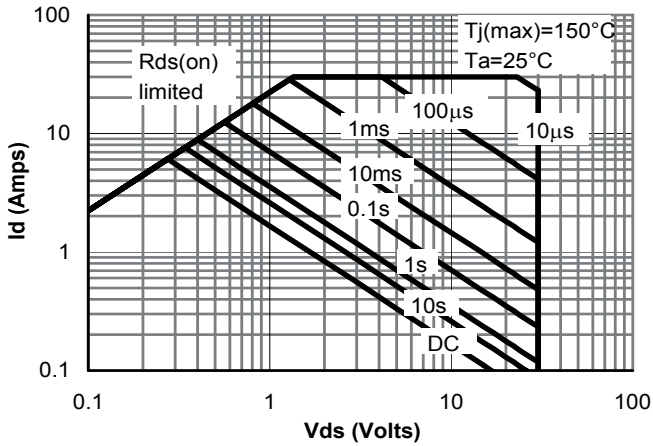

Figure 9: Maximum Forward Biased Safe Operating Area (Note E)

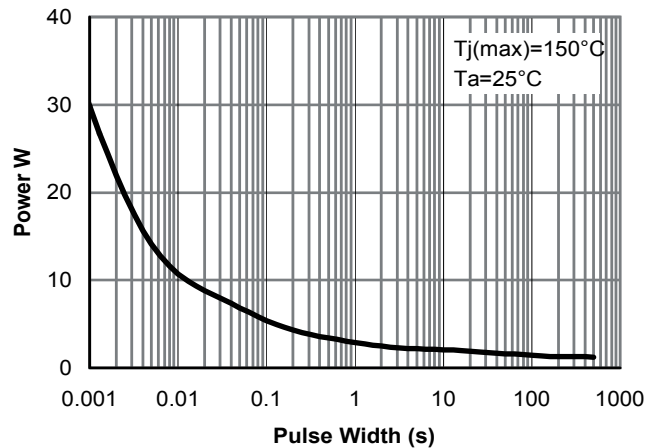

Figure 10: Single Pulse Power Rating Junction-to-Ambient (Note E)

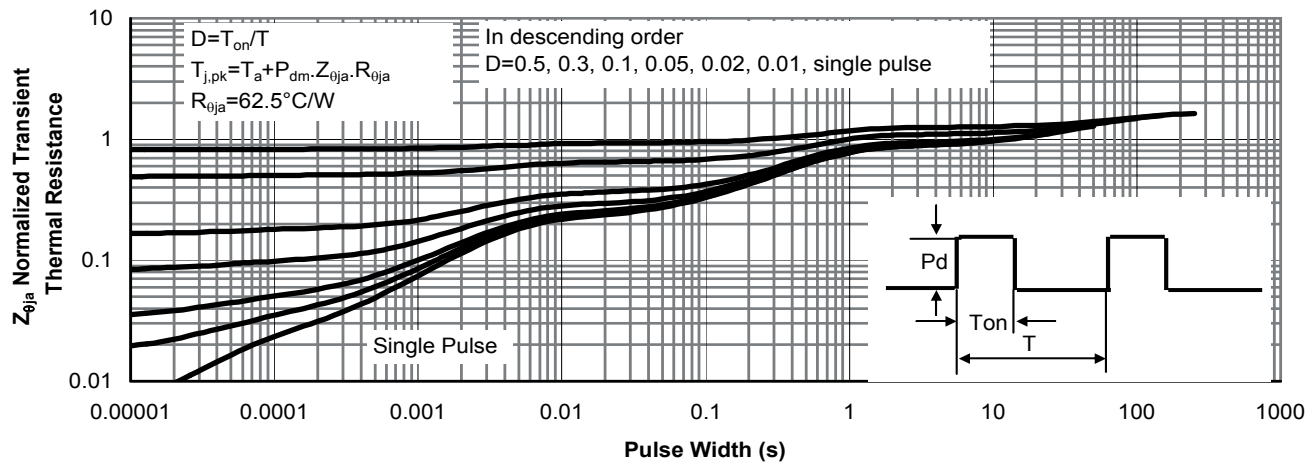

Figure 11: Normalized Maximum Transient Thermal Impedance