

Single N-channel MOSFET

ELM5E402PA-S

■ General description

ELM5E402PA-S uses advanced trench technology to provide excellent $R_{ds(on)}$, low gate charge and low gate resistance.

■ Features

- $V_{ds}=20V$
- $I_d=0.7A$
- $R_{ds(on)} = 360m\Omega$ ($V_{gs}=4.5V$)
- $R_{ds(on)} = 420m\Omega$ ($V_{gs}=2.5V$)
- $R_{ds(on)} = 560m\Omega$ ($V_{gs}=1.8V$)

■ Maximum absolute ratings

Parameter	Symbol	Limit	Unit
Drain-source voltage	V_{ds}	20	V
Gate-source voltage	V_{gs}	± 12	V
Continuous drain current $T_j=150^\circ C$	I_d	$T_a=25^\circ C$	0.7
		$T_a=70^\circ C$	0.4
Pulsed drain current	I_{dm}	1.0	A
Power dissipation	P_d	$T_a=25^\circ C$	0.27
		$T_a=70^\circ C$	0.16
Junction and storage temperature range	T_j, T_{stg}	-55 to 150	$^\circ C$

■ Pin configuration

SOT-523(TOP VIEW)

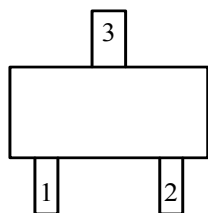

Pin No.	Pin name
1	GATE
2	SOURCE
3	DRAIN

■ Circuit

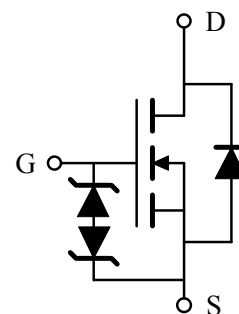

Single N-channel MOSFET

ELM5E402PA-S

■ Electrical characteristics

Ta=25°C

Parameter	Symbol	Condition	Min.	Typ.	Max.	Unit
STATIC PARAMETERS						
Drain-source breakdown voltage	BVdss	Id=250μA, Vgs=0V	20			V
Zero gate voltage drain current	Idss	Vds=16V, Vgs=0V Tj=85°C			1	μA
					5	
Gate-body leakage current	Igss	Vds=0V, Vgs=±12V			±1	mA
Gate threshold voltage	Vgs(th)	Vds=Vgs, Id=250μA	0.3		0.8	V
On state drain current	Id(on)	Vgs=4.5V, Vds=5V	0.7			A
Static drain-source on-resistance	Rds(on)	Vgs=4.5V, Id=0.6A		240	360	mΩ
		Vgs=2.5V, Id=0.5A		300	420	
		Vgs=1.8V, Id=0.4A		420	560	
Forward transconductance	Gfs	Vds=10V, Id=0.4A		1		S
Diode forward voltage	Vsd	Is=0.15A, Vgs=0V		0.65	1.20	V
Max. body-diode continuous current	Is				0.3	A
DYNAMIC PARAMETERS						
Input capacitance	Ciss			70		pF
Output capacitance	Coss	Vgs=0V, Vds=10V, f=1MHz		20		pF
Reverse transfer capacitance	Crss			8		pF
SWITCHING PARAMETERS						
Total gate charge	Qg			1.06	1.38	nC
Gate-source charge	Qgs	Vgs=4.5V, Vds=10V, Id=0.6A		0.18		nC
Gate-drain charge	Qgd			0.32		nC
Turn-on delay time	td(on)			18	26	ns
Turn-on rise time	tr	Vgs=4.5V, Vds=10V		20	28	ns
Turn-off delay time	td(off)	Rl=20Ω, Id=0.5A, Rgen=1Ω		70	110	ns
Turn-off fall time	tf			25	40	ns

Single N-channel MOSFET

ELM5E402PA-S

■ Typical electrical and thermal characteristics

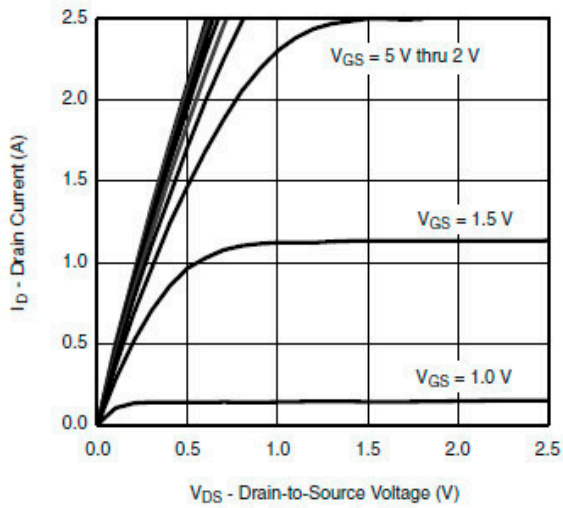

Output Characteristics

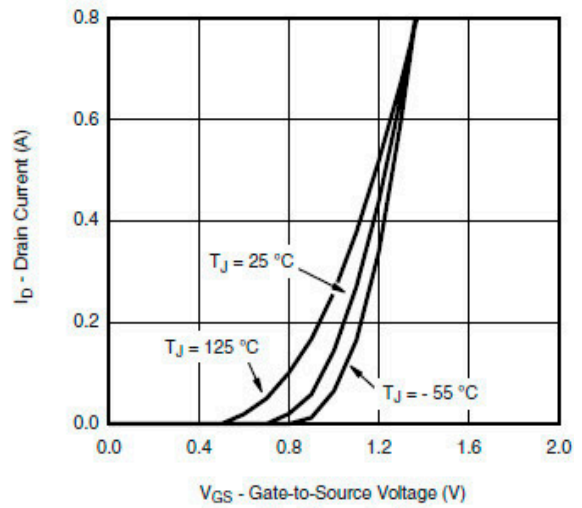

Transfer Characteristics

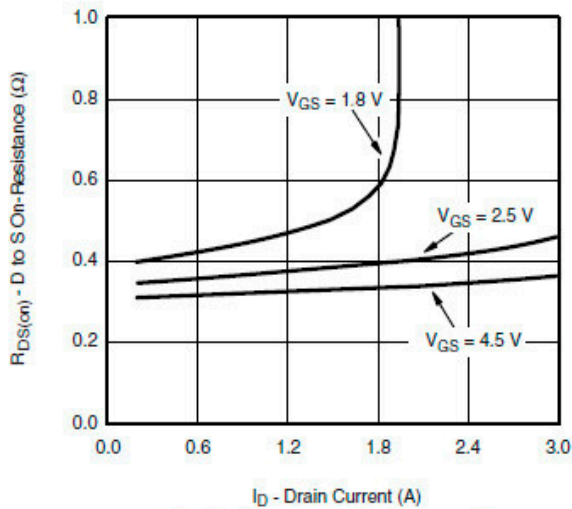

On-Resistance vs. Drain Current

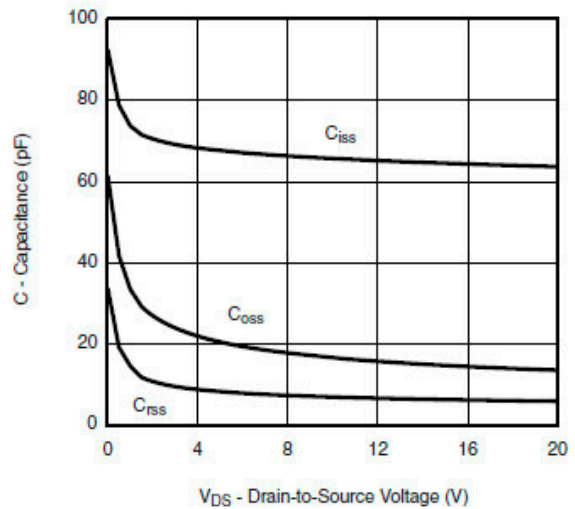

Capacitance

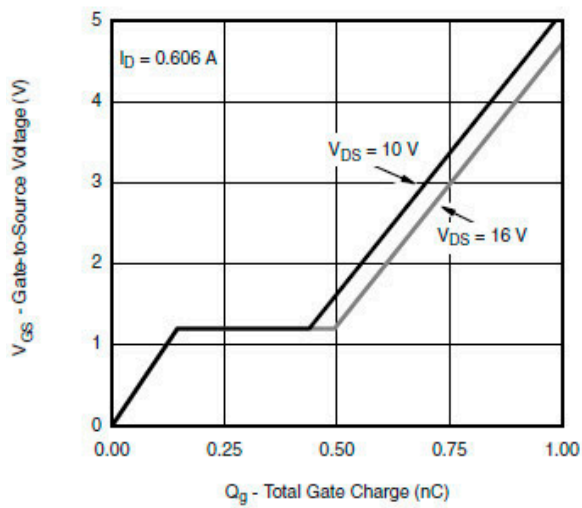

Gate Charge

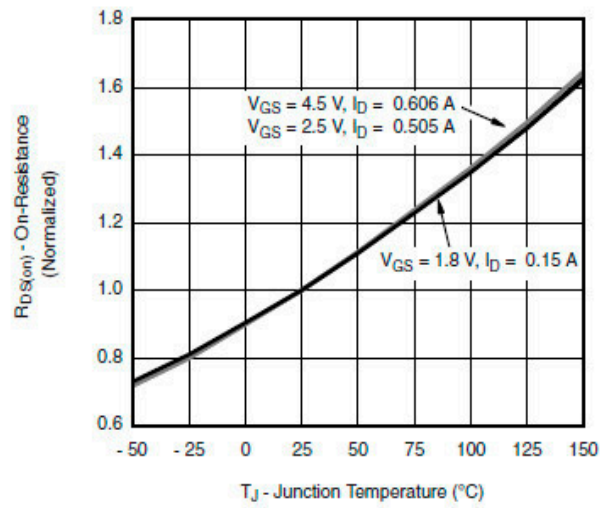

On-Resistance vs. Junction Temperature

Single N-channel MOSFET

ELM5E402PA-S

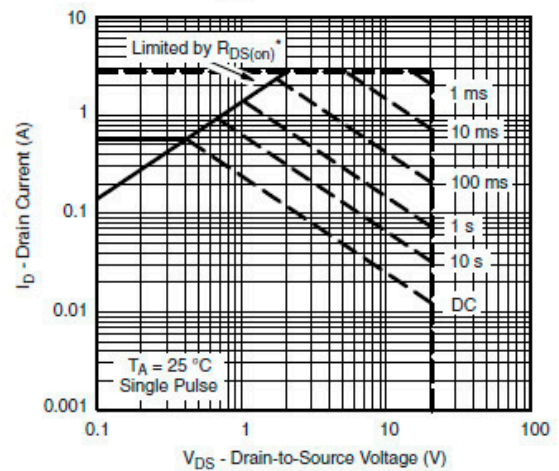
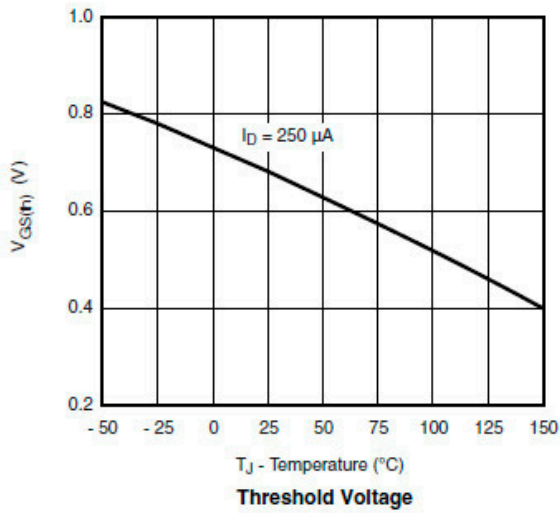
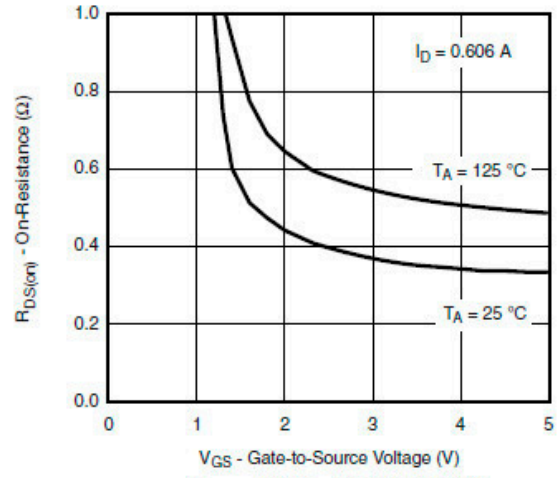
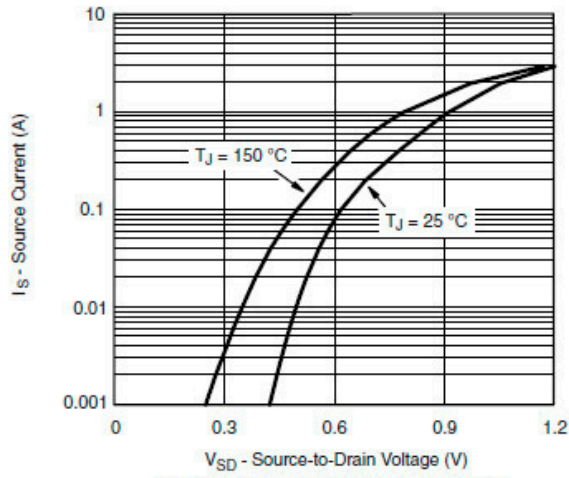

* $V_{GS} >$ minimum V_{GS} at which $R_{DS(on)}$ is specified

Safe Operating Area, Junction-to-Ambient

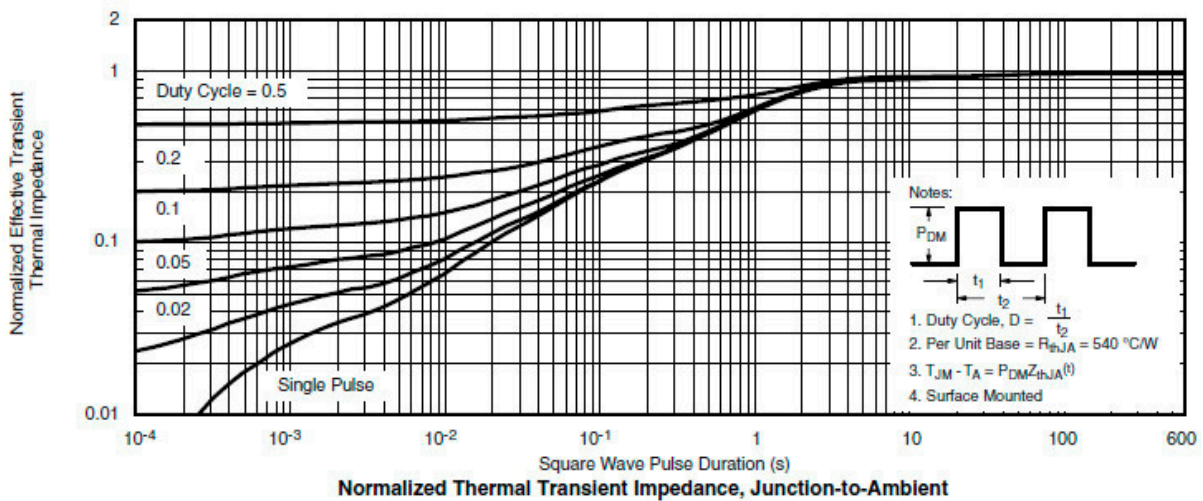

Single N-channel MOSFET

ELM5E402PA-S

■ Test circuit and waveform

Gate Charge Test Circuit & Waveform

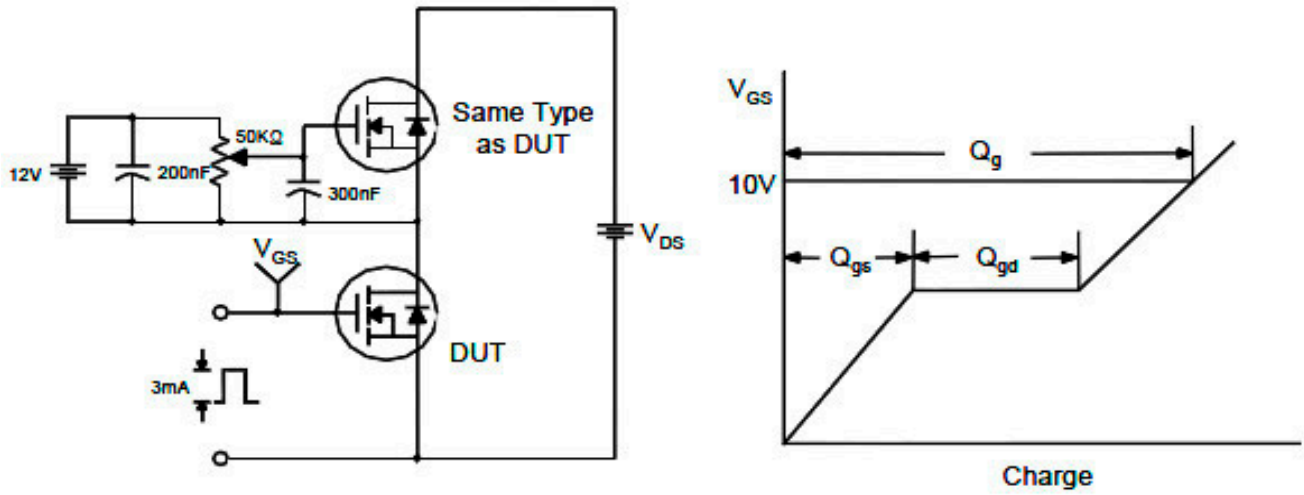

Resistive Switching Test Circuit & Waveforms

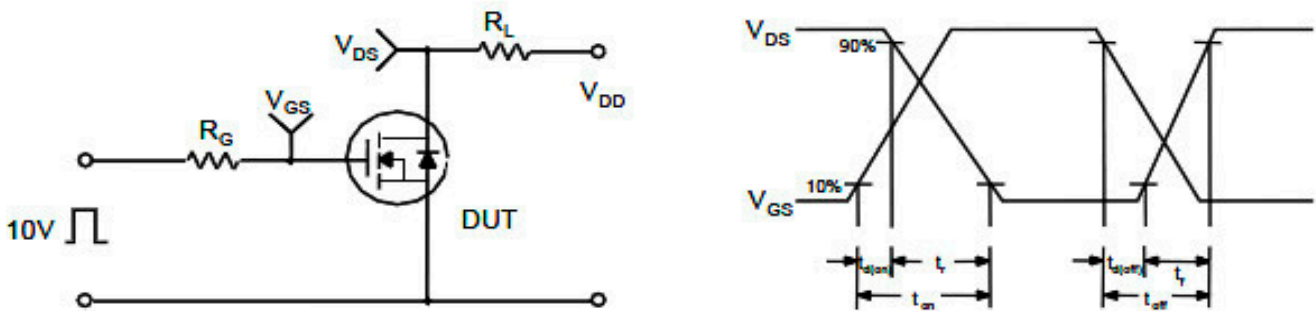

Unclamped Inductive Switching Test Circuit & Waveforms

