

RoHS Compliant Product
A suffix of "-C" specifies halogen and lead-free

DESCRIPTION

These miniature surface mount MOSFETs utilize a high cell density trench process to provide low $R_{DS(on)}$ and to ensure minimal power loss and heat dissipation.

MECHANICAL DATA

- Trench Technology
- Supper high density cell design
- Excellent ON resistance
- Extremely Low Threshold Voltage

APPLICATION

- DC-DC converter circuit
- Load Switch

MARKING

53

PACKAGE INFORMATION

Package	MPQ	Leader Size
SOT-363	3K	7 inch

SOT-363

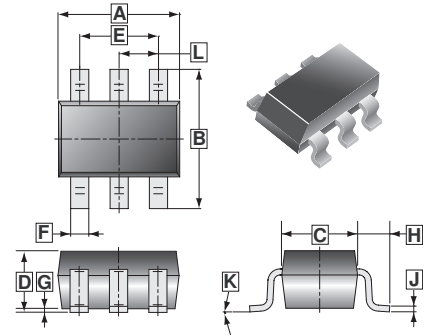

REF.	Millimeter		REF.	Millimeter	
	Min.	Max.		Min.	Max.
A	1.80	2.20	G	0.100	REF.
B	1.80	2.45	H	0.525	REF.
C	1.15	1.35	J	0.08	0.25
D	0.80	1.10	K	8°	
E	1.10	1.50	L	0.650 TYP.	
F	0.10	0.35			

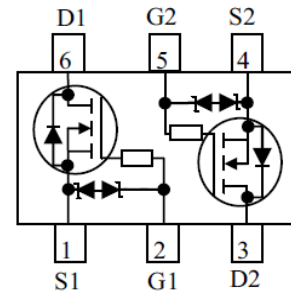

MAXIMUM RATINGS ($T_A = 25^\circ\text{C}$ unless otherwise specified)

Parameter	Symbol	Rating		Unit	
		10S	Steady State		
Drain – Source Voltage	V_{DS}	20		V	
Gate – Source Voltage	V_{GS}	± 6		V	
Continuous Drain Current ¹	I_D	$T_A = 25^\circ\text{C}$	0.89	0.81	A
		$T_A = 70^\circ\text{C}$	0.71	0.64	
Power Dissipation ¹	P_D	$T_A = 25^\circ\text{C}$	0.38	0.31	W
		$T_A = 70^\circ\text{C}$	0.24	0.2	
Continuous Drain Current ²	I_D	$T_A = 25^\circ\text{C}$	0.76	0.69	A
		$T_A = 70^\circ\text{C}$	0.61	0.55	
Power Dissipation ²	P_D	$T_A = 25^\circ\text{C}$	0.28	0.23	W
		$T_A = 70^\circ\text{C}$	0.17	0.15	
Pulsed Drain Current ³	I_{DM}	1.4		A	
Lead Temperature	T_L	260		$^\circ\text{C}$	
Operating Junction & Storage Temperature Range	T_J, T_{STG}	150, -55~150		$^\circ\text{C}$	

THERMAL RESISTANCE RATINGS

Parameter	Symbol	Rating		Unit	
		Typ.	Max.		
Single Operation					
Junction-to-Ambient Thermal Resistance ¹	$T \leq 10S$	$R_{\theta JA}$	276	325	°C / W
	Steady State		328	395	
Junction-to-Ambient Thermal Resistance ²	$T \leq 10S$	$R_{\theta JA}$	375	445	
	Steady State		446	532	
Junction-to-Case Thermal Resistance	Steady State	$R_{\theta JC}$	260	300	
Dual Operation					
Junction-to-Ambient Thermal Resistance ¹	$T \leq 10S$	$R_{\theta JA}$	310	360	°C / W
	Steady State		366	432	
Junction-to-Ambient Thermal Resistance ²	$T \leq 10S$	$R_{\theta JA}$	415	486	
	Steady State		498	575	
Junction-to-Case Thermal Resistance	Steady State	$R_{\theta JC}$	265	305	

Note:

1. Surface mounted on FR4 Board using 1 square inch pad size, 1oz copper.
2. Surface mounted on FR4 board using minimum pad size, 1oz copper
3. Repetitive rating, pulse width limited by junction temperature, $t_p=10\mu s$, Duty Cycle=1%
4. Repetitive rating, pulse width limited by junction temperature $T_J=150^\circ C$.

ELECTRICAL CHARACTERISTICS ($T_A=25^\circ C$ unless otherwise specified)

Parameter	Symbol	Min.	Typ.	Max.	Unit	Teat Conditions
Static						
Drain-Source Breakdown Voltage	$V_{(BR)DSS}$	20	-	-	V	$V_{GS}=0, I_D=250\mu A$
Zero Gate Voltage Drain Current	I_{DSS}	-	-	1	μA	$V_{DS}=16V, V_{GS}=0$
Gate-Source Leakage	I_{GSS}	-	-	± 5	μA	$V_{DS}=0, V_{GS}= \pm 5V$
Gate-Threshold Voltage	$V_{GS(TH)}$	0.45	0.58	0.85	V	$V_{DS}=V_{GS}, I_D=250\mu A$
Drain-Source On Resistance	$R_{DS(ON)}$	-	220	310	m Ω	$V_{GS}=4.5V, I_D=0.55A$
		-	260	360		$V_{GS}=2.5V, I_D=0.45A$
		-	320	460		$V_{GS}=1.8V, I_D=0.35A$
Forward Transconductance	g_{FS}	-	2	-	S	$V_{DS}=5V, I_D= 0.55A$
Body-Drain Diode Ratings						
Diode Forward On-Voltage	V_{SD}	0.5	0.7	1.5	V	$I_S=350mA, V_{GS}=0$
Dynamic Characteristics						
Input Capacitance	C_{ISS}	-	50	-	pF	$V_{DS}=10V, V_{GS}=0, f=100KHz$
Output Capacitance	C_{OSS}	-	13	-		
Reverse Transfer Capacitance	C_{RSS}	-	8	-		
Total Gate Charge	$Q_{G(TOT)}$	-	1.15	-	nC	$V_{DS}=10V, V_{GS}=4.5V, I_D=0.55A$
Threshold Gate Charge	$Q_{G(TH)}$	-	0.06	-		
Gate-to-Source Charge	Q_{GS}	-	0.15	-		
Gate-to-Drain Charge	Q_{GD}	-	0.23	-		
Turn-on Delay Time	$T_{d(ON)}$	-	22	-	nS	$V_{DD}=10V, I_D=0.55A, V_{GS}=4.5V, R_G=6\Omega.$
Rise Time	T_r	-	80	-		
Turn-off Delay Time	$T_{d(OFF)}$	-	700	-		
Fall Time	T_f	-	380	-		

CHARACTERISTIC CURVES

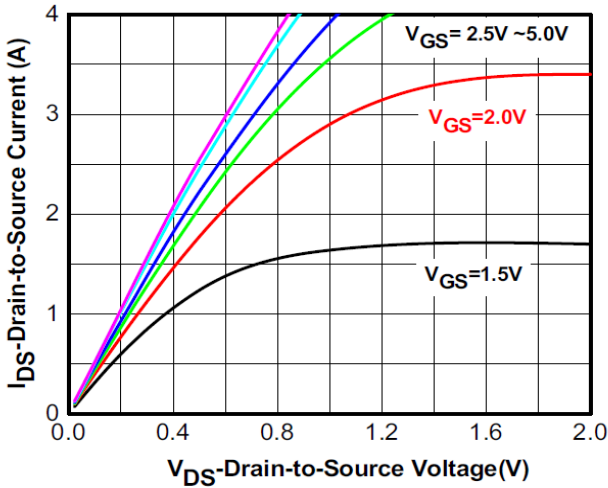

Output characteristics

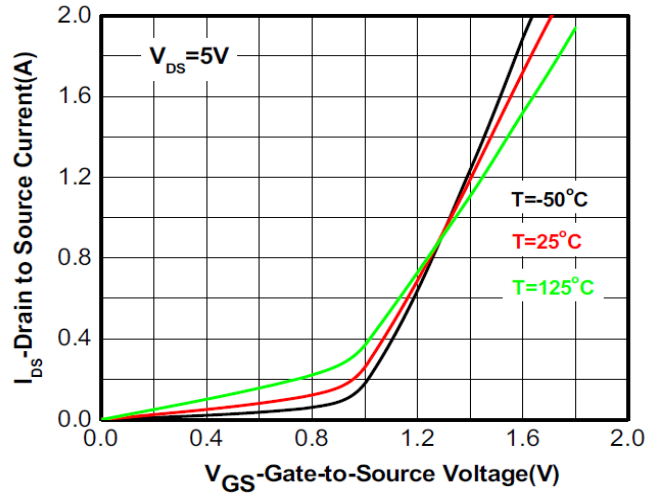

Transfer characteristics

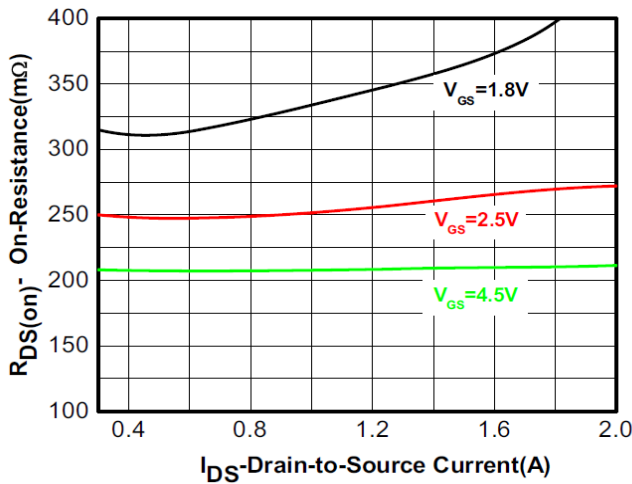

On-Resistance vs. Drain current

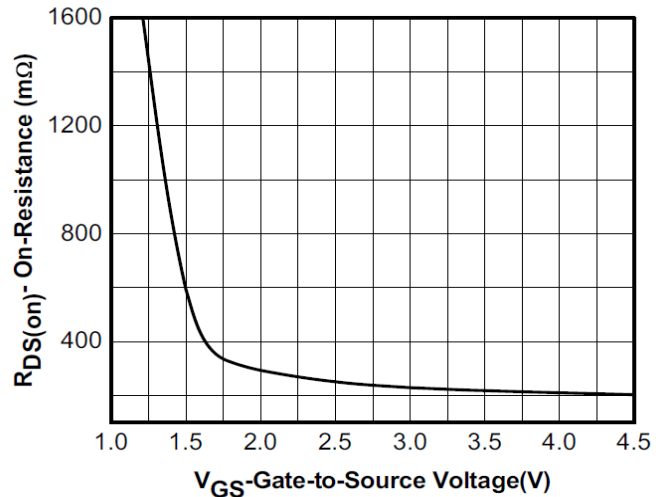

On-Resistance vs. Gate-to-Source voltage

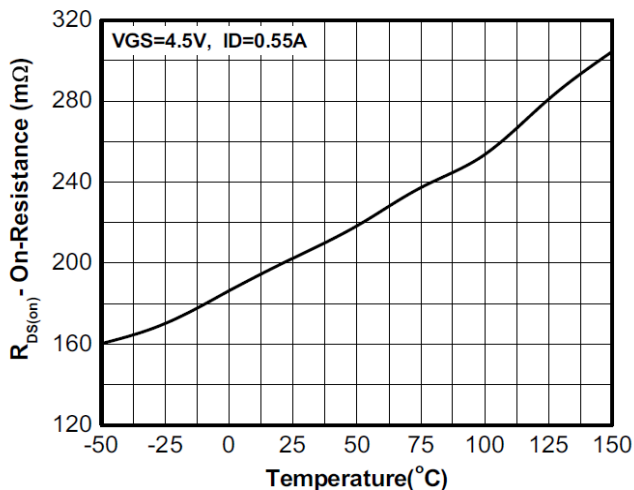

On-Resistance vs. Junction temperature

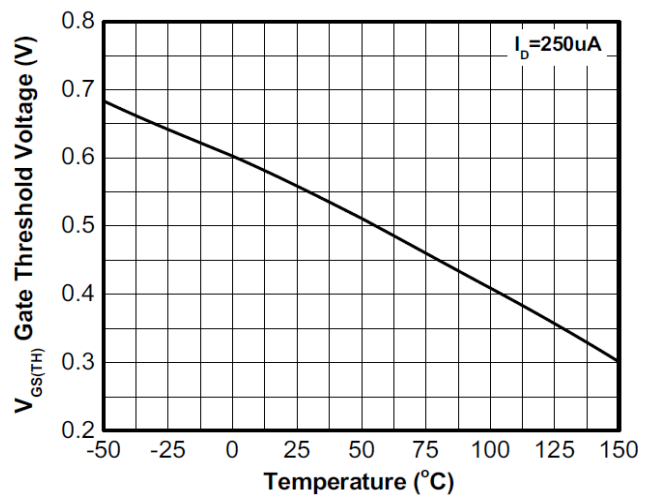

Threshold voltage vs. Temperature

CHARACTERISTIC CURVES

