

# Small Signal MOSFET

## 115 mAmps, 60 Volts

### N-Channel SC-74

**L2N7002DMT1G**

- We declare that the material of product compliance with RoHS requirements.

#### MAXIMUM RATINGS

Rating	Symbol	Value	Unit
Drain-Source Voltage	$V_{DSS}$	60	V <sub>dc</sub>
Drain-Gate Voltage ( $R_{GS} = 1.0 \text{ M}\Omega$ )	$V_{DGR}$	60	V <sub>dc</sub>
Drain Current	$I_D$	$\pm 115$	mAdc
– Continuous $T_C = 25^\circ\text{C}$ (Note 1.)	$I_D$	$\pm 75$	
– Pulsed (Note 2.)	$I_{DM}$	$\pm 800$	
Gate-Source Voltage	$V_{GS}$	$\pm 20$	V <sub>dc</sub>
– Continuous	$V_{GSM}$	$\pm 40$	V <sub>pk</sub>
– Non-repetitive ( $t_p \leq 50 \mu\text{s}$ )			

#### THERMAL CHARACTERISTICS

Characteristic	Symbol	Max	Unit
Total Device Dissipation FR-5 Board (Note 3.) $T_A = 25^\circ\text{C}$ Derate above $25^\circ\text{C}$	$P_D$	225 1.8	mW mW/ $^\circ\text{C}$
Thermal Resistance, Junction to Ambient	$R_{\theta JA}$	556	$^\circ\text{C}/\text{W}$
Total Device Dissipation Alumina Substrate, (Note 4.) $T_A = 25^\circ\text{C}$ Derate above $25^\circ\text{C}$	$P_D$	300 2.4	mW mW/ $^\circ\text{C}$
Thermal Resistance, Junction to Ambient	$R_{\theta JA}$	417	$^\circ\text{C}/\text{W}$
Junction and Storage Temperature	$T_J, T_{stg}$	-55 to +150	$^\circ\text{C}$

1. The Power Dissipation of the package may result in a lower continuous drain current.
2. Pulse Test: Pulse Width  $\leq 300 \mu\text{s}$ , Duty Cycle  $\leq 2.0\%$ .
3. FR-5 = 1.0 x 0.75 x 0.062 in.
4. Alumina = 0.4 x 0.3 x 0.025 in 99.5% alumina.

#### ORDERING INFORMATION

Device	Marking	Shipping
L2N7002DMT1G	72D	3000 Tape & Reel
L2N7002DMT3G	72D	10000 Tape & Reel

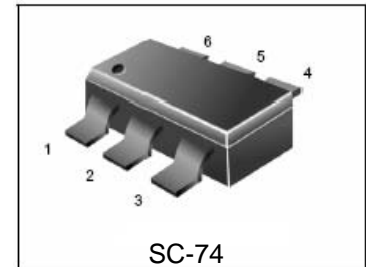

**115 mAmps**  
**60 VOLTS**  
 **$R_{DS(on)} = 7.5 \Omega$**   
N - Channel

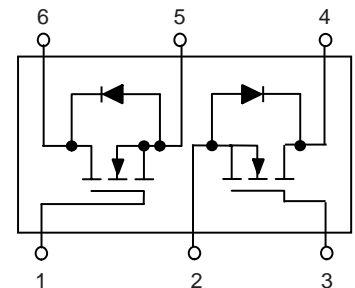

**L2N7002DMT1G**
**ELECTRICAL CHARACTERISTICS** ( $T_A = 25^\circ\text{C}$  unless otherwise noted)

Characteristic	Symbol	Min	Typ	Max	Unit
<b>OFF CHARACTERISTICS</b>					
Drain–Source Breakdown Voltage ( $V_{GS} = 0, I_D = 250\mu\text{A}$ )	$V_{(BR)DSS}$	60	–	–	Vdc
Zero Gate Voltage Drain Current ( $V_{GS} = 0, V_{DS} = 60\text{ Vdc}$ )	$I_{DSS}$	– –	– –	1.0 500	$\mu\text{A}$ dc
Gate–Body Leakage Current, Forward ( $V_{GS} = 20\text{ Vdc}$ )	$I_{GSSF}$	–	–	100	nA
Gate–Body Leakage Current, Reverse ( $V_{GS} = -20\text{ Vdc}$ )	$I_{GSSR}$	–	–	-100	nA

**ON CHARACTERISTICS** (Note 2.)

Gate Threshold Voltage ( $V_{DS} = V_{GS}, I_D = 250\mu\text{A}$ )	$V_{GS(th)}$	1.0	1.6	2	Vdc
On–State Drain Current ( $V_{DS} \geq 2.0 V_{DS(on)}, V_{GS} = 10\text{ Vdc}$ )	$I_{D(on)}$	500	–	–	mA
Static Drain–Source On–State Voltage ( $V_{GS} = 10\text{ Vdc}, I_D = 500\text{ mA}$ ) ( $V_{GS} = 5.0\text{ Vdc}, I_D = 50\text{ mA}$ )	$V_{DS(on)}$	– –	– –	3.75 0.375	Vdc
Static Drain–Source On–State Resistance ( $V_{GS} = 10\text{ V}, I_D = 500\text{ mA}$ ) $T_C = 25^\circ\text{C}$ $T_C = 125^\circ\text{C}$ ( $V_{GS} = 5.0\text{ Vdc}, I_D = 50\text{ mA}$ ) $T_C = 25^\circ\text{C}$ $T_C = 125^\circ\text{C}$	$r_{DS(on)}$	– – – –	1.4 – 1.8 –	7.5 13.5 7.5 13.5	Ohms
Forward Transconductance ( $V_{DS} \geq 2.0 V_{DS(on)}, I_D = 200\text{ mA}$ )	$g_{FS}$	80	–	–	mmhos

**DYNAMIC CHARACTERISTICS**

Input Capacitance ( $V_{DS} = 25\text{ Vdc}, V_{GS} = 0, f = 1.0\text{ MHz}$ )	$C_{iss}$	–	17	50	pF
Output Capacitance ( $V_{DS} = 25\text{ Vdc}, V_{GS} = 0, f = 1.0\text{ MHz}$ )	$C_{oss}$	–	10	25	pF
Reverse Transfer Capacitance ( $V_{DS} = 25\text{ Vdc}, V_{GS} = 0, f = 1.0\text{ MHz}$ )	$C_{rss}$	–	2.5	5.0	pF

**SWITCHING CHARACTERISTICS** (Note 2.)

Turn–On Delay Time	( $V_{DD} = 25\text{ Vdc}, I_D \cong 500\text{ mA}$ , $R_G = 25\ \Omega, R_L = 50\ \Omega, V_{gen} = 10\text{ V}$ )	$t_{d(on)}$	–	7	20	ns
Turn–Off Delay Time		$t_{d(off)}$	–	11	40	ns

**BODY–DRAIN DIODE RATINGS**

Diode Forward On–Voltage ( $I_S = 115\text{ mA}, V_{GS} = 0\text{ V}$ )	$V_{SD}$	–	–	-1.5	Vdc
Source Current Continuous (Body Diode)	$I_S$	–	–	-115	mA
Source Current Pulsed	$I_{SM}$	–	–	-800	mA

 2. Pulse Test: Pulse Width  $\leq 300\ \mu\text{s}$ , Duty Cycle  $\leq 2.0\%$ .

L2N7002DMT1G

TYPICAL ELECTRICAL CHARACTERISTICS

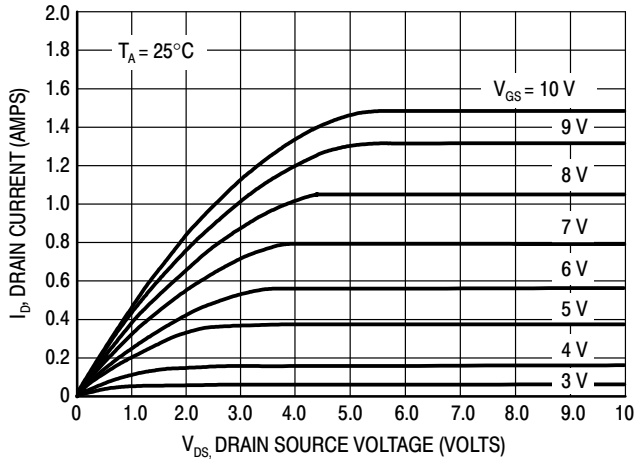

Figure 1. Ohmic Region

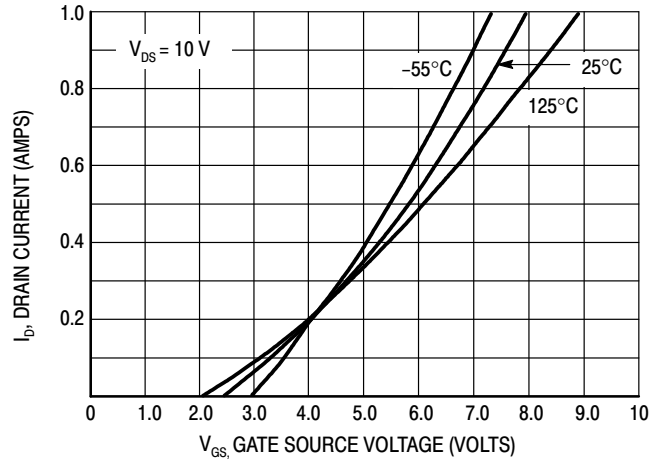

Figure 2. Transfer Characteristics

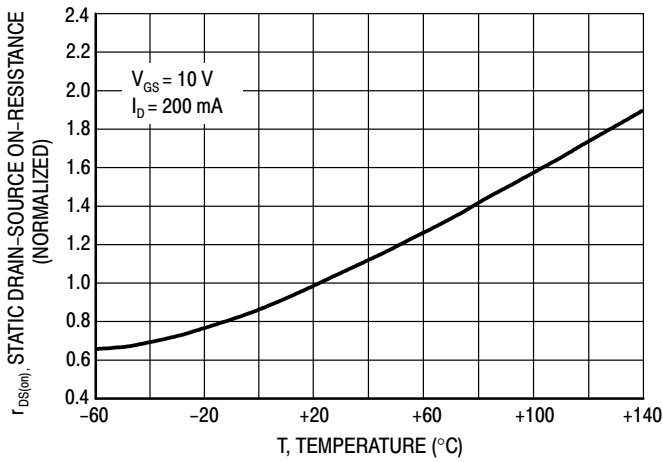

Figure 3. Temperature versus Static Drain-Source On-Resistance

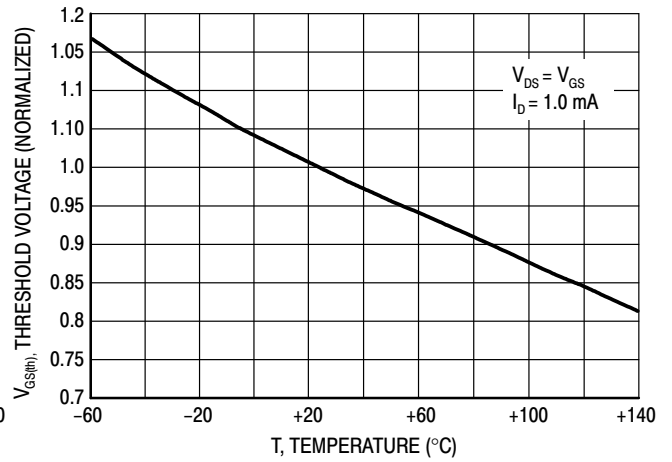
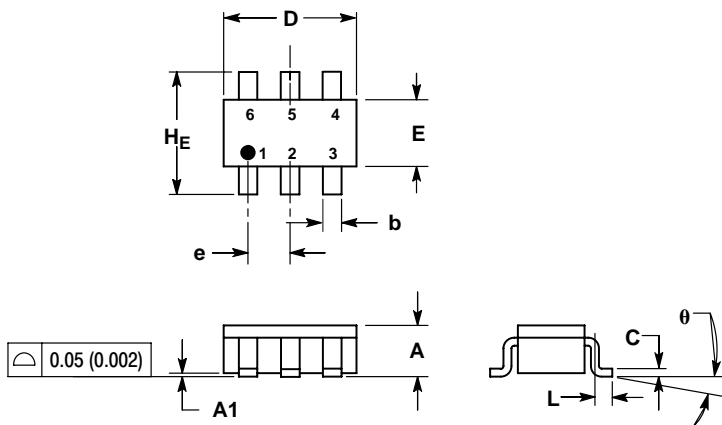
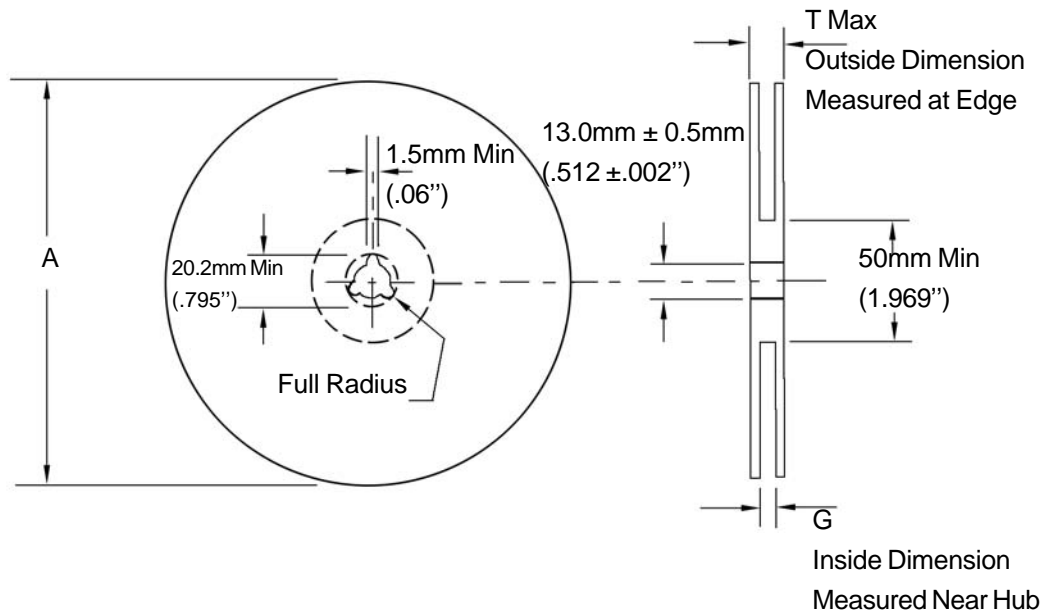

Figure 4. Temperature versus Gate Threshold Voltage

**L2N7002DMT1G**
**SC-74**

DIM	MILLIMETERS			INCHES		
	MIN	NOM	MAX	MIN	NOM	MAX
A	0.90	1.00	1.10	0.035	0.039	0.043
A1	0.01	0.06	0.10	0.001	0.002	0.004
b	0.25	0.37	0.50	0.010	0.015	0.020
c	0.10	0.18	0.26	0.004	0.007	0.010
D	2.90	3.00	3.10	0.114	0.118	0.122
E	1.30	1.50	1.70	0.051	0.059	0.067
e	0.85	0.95	1.05	0.034	0.037	0.041
L	0.20	0.40	0.60	0.008	0.016	0.024
HE	2.50	2.75	3.00	0.099	0.108	0.118
$\theta$	0°	-	10°	0°	-	10°

## EMBOSSED TAPE AND REEL DATA FOR DISCRETES



Size	A Max	G	T Max
8 mm	178.0mm (7.0")	8.4mm+1.5mm, -0.0 (.33"+.039", -0.00)	10.9mm (.43")

### Reel Dimensions

Metric Dimensions Govern — English are in parentheses for reference only

#### Storage Conditions

Temperature: 5 to 40 Deg.C (20 to 30 Deg. C is preferred)

Humidity: 30 to 80 RH (40 to 60 is preferred)

Recommended Period: One year after manufacturing

(This recommended period is for the soldering condition only. The characteristics and reliabilities of the products are not restricted to this limitation)

# Shipment Specification

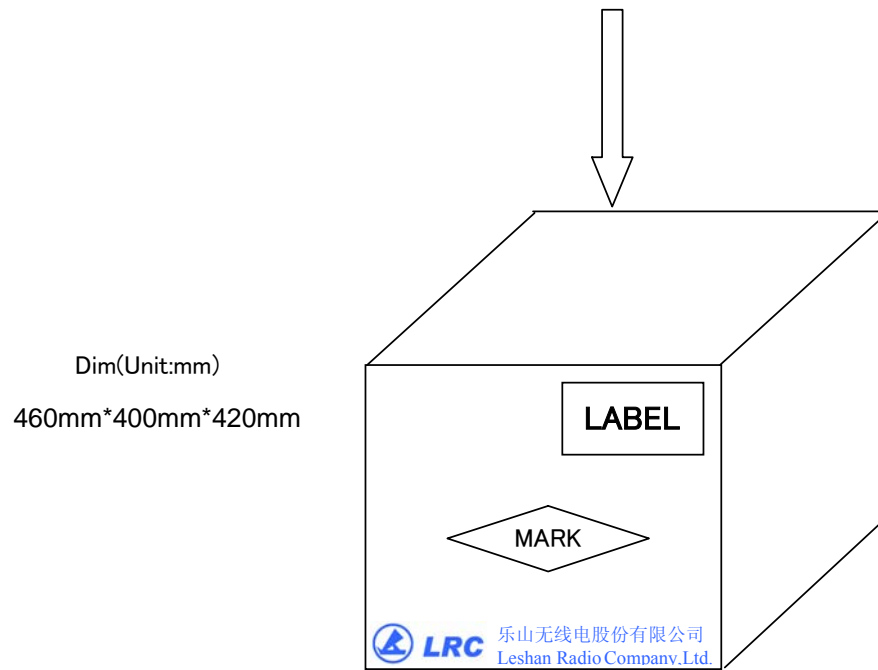
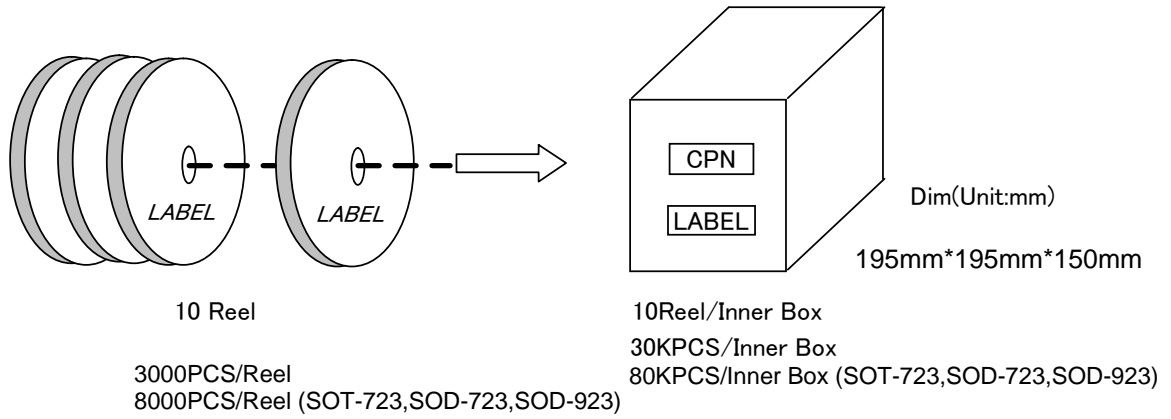

12 Inner Box/Carton

360KPCS/Carton  
960KPCS/Carton (SOT-723,SOD-723,SOD-923)