

Silicon N-channel MOSFET

100 mA, 30 V

• Features

- 1) Low on-resistance.
 - 2) Fast switching speed.
 - 3) Low voltage drive (2.5V) makes this device ideal for portable equipment.
 - 4) Easily designed drive circuits.
 - 5) Easy to parallel.
- We declare that the material of product compliance with RoHS requirements.

MAXIMUM RATINGS

Parameter	Symbol	Limits	Unit
Drain-source voltage	V_{DS}	30	V
Gate-source voltage	V_{GS}	± 20	V
Drain current	Continuous	I_D	± 100 mA
	Pulsed	I_{DP}^{*1}	± 400 mA
Total power dissipation ($T_c=25^\circ\text{C}$)	P_D^{*2}	200	mW
Channel temperature	T_{ch}	150	$^\circ\text{C}$
Storage temperature	T_{stg}	-55 to +150	$^\circ\text{C}$

*1 $P_w \leq 10\mu\text{s}$, Duty cycle $\leq 1\%$

*2 With each pin mounted on the recommended lands.

ORDERING INFORMATION

Device	Marking	Shipping
L2SK3018WT1G	KN	3000 Tape & Reel
L2SK3018WT3G	KN	10000 Tape & Reel

L2SK3018WT1G

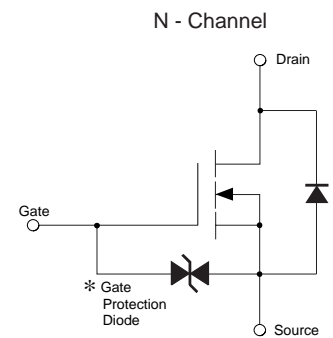
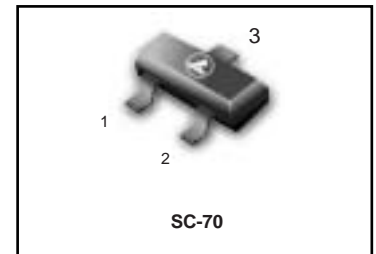

*A protection diode is included between the gate and the source terminals to protect the diode against static electricity when the product is in use. Use a protection circuit when the fixed voltages are exceeded.

MARKING DIAGRAM & PIN ASSIGNMENT

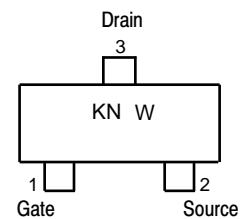

KN = Device Code
W = Work Week

L2SK3018WT1G

ELECTRICAL CHARACTERISTICS ($T_A = 25^\circ\text{C}$ unless otherwise noted)

Parameter	Symbol	Min.	Typ.	Max.	Unit	Conditions
Gate-source leakage	I_{GSS}	–	–	± 1	μA	$V_{GS} = \pm 20\text{V}, V_{DS} = 0\text{V}$
Drain-source breakdown voltage	$V_{(BR)DSS}$	30	–	–	V	$I_D = 10\mu\text{A}, V_{GS} = 0\text{V}$
Zero gate voltage drain current	I_{DSS}	–	–	1	μA	$V_{DS} = 30\text{V}, V_{GS} = 0\text{V}$
Gate threshold voltage	$V_{GS(th)}$	0.8	–	1.5	V	$V_{DS} = 3\text{V}, I_D = 100\mu\text{A}$
Static drain-source on-state resistance	$R_{DS(on)}$	–	5	8	Ω	$I_D = 10\text{mA}, V_{GS} = 4\text{V}$
	$R_{DS(on)}$	–	7	13	Ω	$I_D = 1\text{mA}, V_{GS} = 2.5\text{V}$
Forward transfer admittance	$ Y_{fs} $	20	–	–	mS	$V_{DS} = 3\text{V}, I_D = 10\text{mA}$
Input capacitance	C_{iss}	–	13	–	pF	$V_{DS} = 5\text{V}$
Output capacitance	C_{oss}	–	9	–	pF	$V_{GS} = 0\text{V}$
Reverse transfer capacitance	C_{rss}	–	4	–	pF	$f = 1\text{MHz}$
Turn-on delay time	$t_{d(on)}$	–	15	–	ns	$I_D = 10\text{mA}, V_{DD} \approx 5\text{V}$
Rise time	t_r	–	35	–	ns	$V_{GS} = 5\text{V}$
Turn-off delay time	$t_{d(off)}$	–	80	–	ns	$R_L = 500\Omega$
Fall time	t_f	–	80	–	ns	$R_G = 10\Omega$

L2SK3018WT1G

TYPICAL ELECTRICAL CHARACTERISTICS

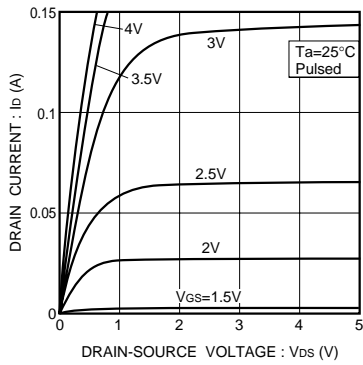

Fig.1 Typical output characteristics

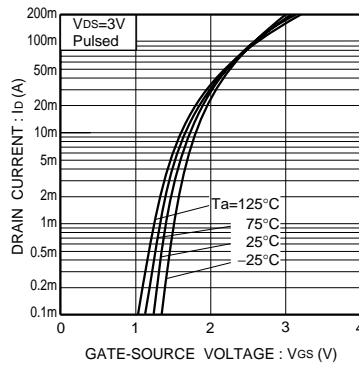

Fig.2 Typical transfer characteristics

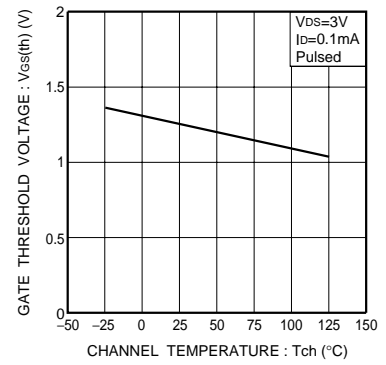

Fig.3 Gate threshold voltage vs. channel temperature

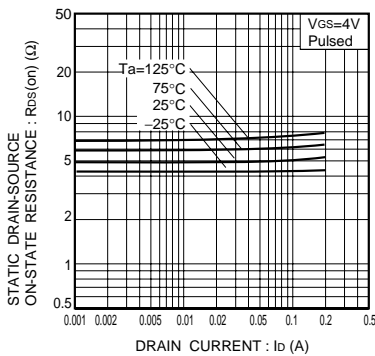

Fig.4 Static drain-source on-state resistance vs. drain current (I)

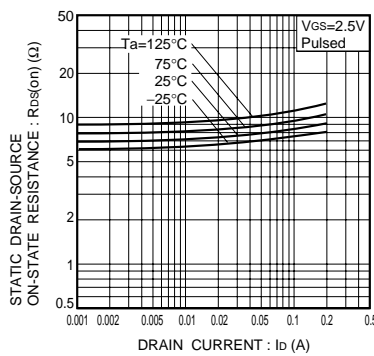

Fig.5 Static drain-source on-state resistance vs. drain current (II)

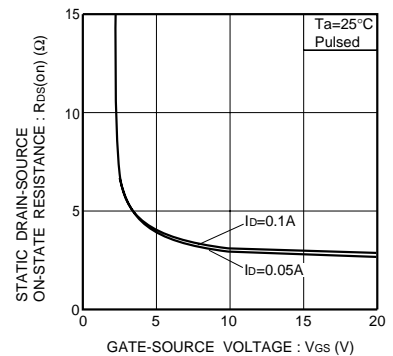

Fig.6 Static drain-source on-state resistance vs. gate-source voltage

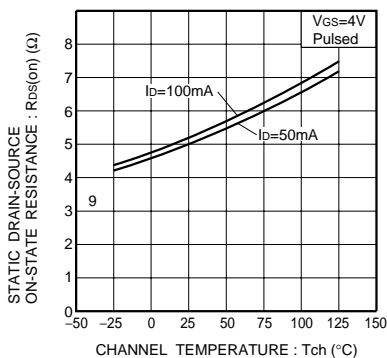

Fig.7 Static drain-source on-state resistance vs. channel temperature

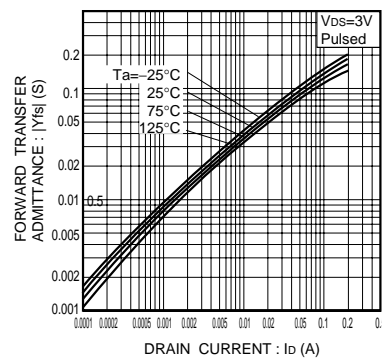

Fig.8 Forward transfer admittance vs. drain current

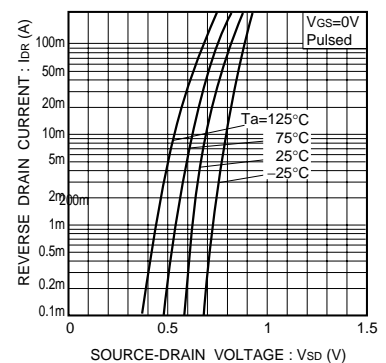

Fig.9 Reverse drain current vs. source-drain voltage (I)

L2SK3018WT1G

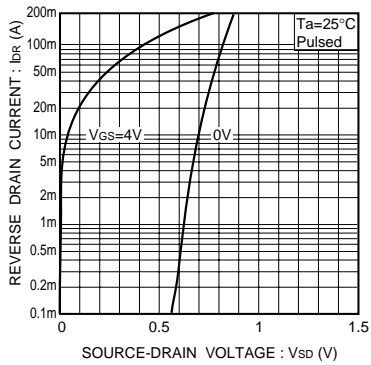

Fig.10 Reverse drain current vs. source-drain voltage (II)

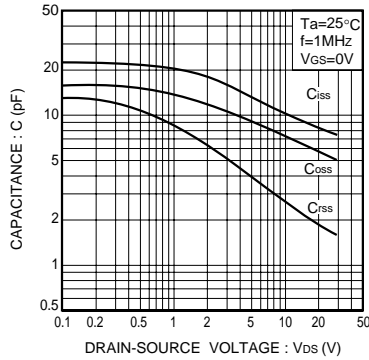

Fig.11 Typical capacitance vs. drain-source voltage

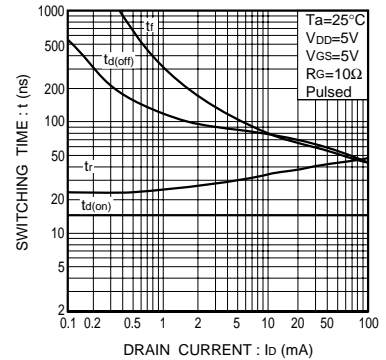

Fig.12 Switching characteristics (See Figures 13 and 14 for the measurement circuit and resultant waveforms)

● Switching characteristics measurement circuit

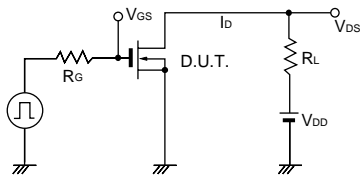

Fig.13 Switching time measurement circuit

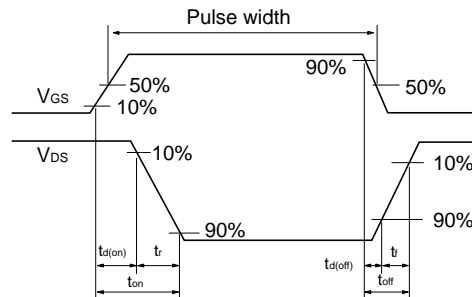
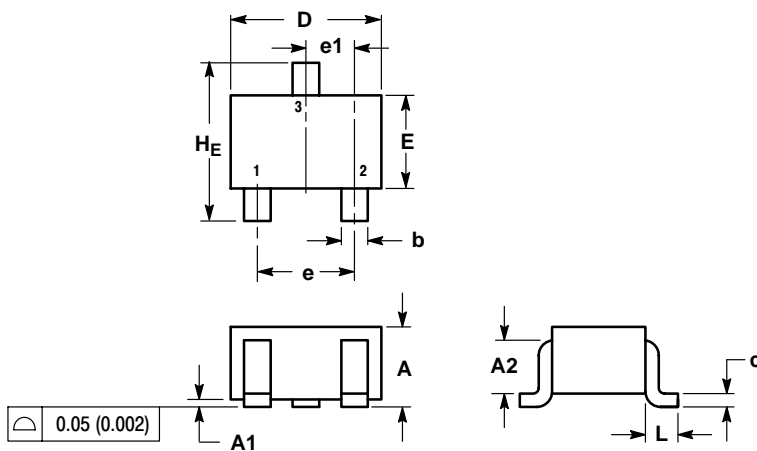
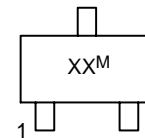

Fig.14 Switching time waveforms

L2SK3018WT1G
SC-70

NOTES:

1. DIMENSIONING AND TOLERANCING PER ANSI Y14.5M, 1982.
2. CONTROLLING DIMENSION: INCH.

DIM	MILLIMETERS			INCHES		
	MIN	NOM	MAX	MIN	NOM	MAX
A	0.80	0.90	1.00	0.032	0.035	0.040
A1	0.00	0.05	0.10	0.000	0.002	0.004
A2	0.7 REF			0.028 REF		
b	0.30	0.35	0.40	0.012	0.014	0.016
c	0.10	0.18	0.25	0.004	0.007	0.010
D	1.80	2.10	2.20	0.071	0.083	0.087
E	1.15	1.24	1.35	0.045	0.049	0.053
e	1.20	1.30	1.40	0.047	0.051	0.055
e1	0.65 BSC			0.026 BSC		
L	0.425 REF			0.017 REF		
HE	2.00	2.10	2.40	0.079	0.083	0.095

GENERIC MARKING DIAGRAM

- XX = Specific Device Code
- M = Date Code
- = Pb-Free Package

*This information is generic. Please refer to device data sheet for actual part marking. Pb-Free indicator, "G" or microdot "▪", may or may not be present.

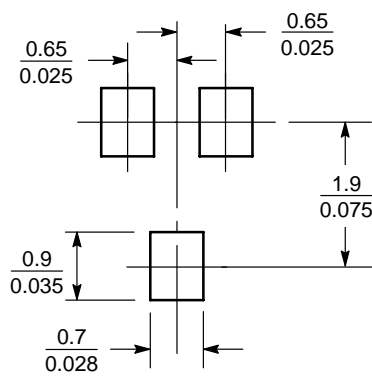
SOLDERING FOOTPRINT*

SCALE 10:1 (mm/inches)