



ELECTROSTATIC SENSITIVE DEVICE
OBSERVE HANDLING PRECAUTIONS

MITSUBISHI RF POWER MOS FET

RD00HVS1

RoHS Compliance, Silicon MOSFET Power Transistor 175MHz,0.5W

DESCRIPTION

RD00HVS1 is a MOS FET type transistor specifically designed for VHF/UHF RF amplifiers applications.

FEATURES

High power gain
Pout>0.5W, Gp>20dB @Vdd=12.5V,f=175MHz

APPLICATION

For output stage of high power amplifiers in VHF/UHF Band mobile radio sets.

RoHS COMPLIANT

RD00HVS1-101,T113 is a RoHS compliant products.

This product include the lead in high melting temperature type solders.
How ever,it applicable to the following exceptions of RoHS Directions.

- 1.Lead in high melting temperature type solders(i.e.tin-lead solder alloys containing more than85% lead.)

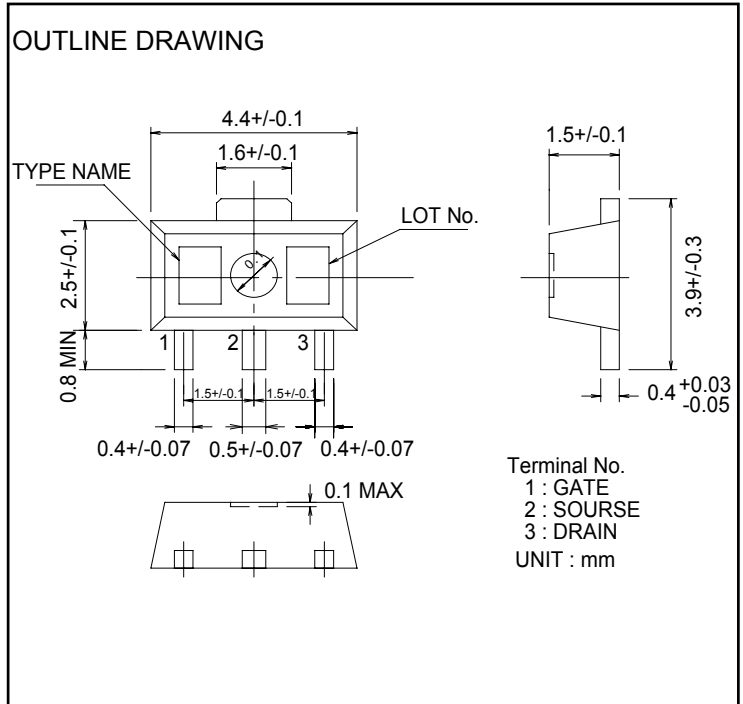

ABSOLUTE MAXIMUM RATINGS

(Tc=25°C UNLESS OTHERWISE NOTED)

SYMBOL	PARAMETER	CONDITIONS	RATINGS	UNIT
VDSS	Drain to source voltage	Vgs=0V	30	V
VGSS	Gate to source voltage	Vds=0V	+/-10	V
Pch	Channel dissipation	Tc=25°C	3.1	W
Pin	Input Power	Zg=Zl=50Ω	20	mW
ID	Drain Current	-	200	mA
Tch	Channel Temperature	-	150	°C
Tstg	Storage temperature	-	-40 to +125	°C
Rth j-c	Thermal resistance	Junction to case	40	°C/W

Note : Above parameters are guaranteed independently.

ELECTRICAL CHARACTERISTICS

(Tc=25deg.C , UNLESS OTHERWISE NOTED)

SYMBOL	PARAMETER	CONDITIONS	LIMITS			UNIT
			MIN	TYP	MAX.	
IDSS	Zero gate voltage drain current	VDS=17V, VGS=0V	-	-	25	uA
IGSS	Gate to source leak current	VGS=10V, VDS=0V	-	-	1	uA
Vth	Gate threshold Voltage	VDS=12V, IDS=1mA	1	2	3	V
Pout	Output power	VDD=12.5V, Pin=5mW, f=175MHz, Idq=50mA	0.5	0.8	-	W
ηD	Drain efficiency		50	60	-	%

Note : Above parameters , ratings , limits and conditions are subject to change.

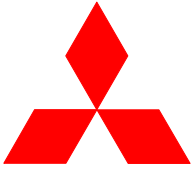

ELECTROSTATIC SENSITIVE DEVICE
OBSERVE HANDLING PRECAUTIONS

MITSUBISHI RF POWER MOS FET

RD00HVS1

RoHS Compliance, Silicon MOSFET Power Transistor 175MHz,0.5W

TYPICAL CHARACTERISTICS

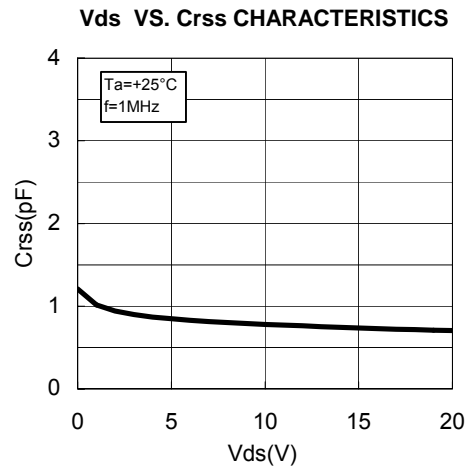
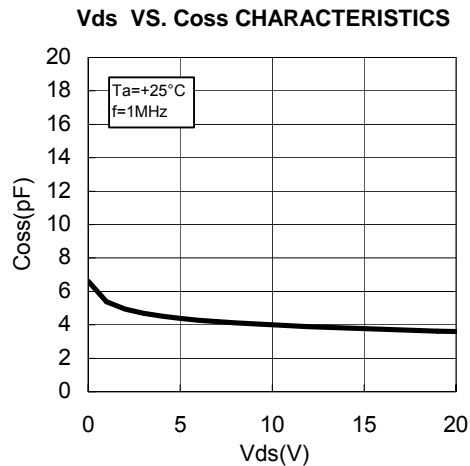
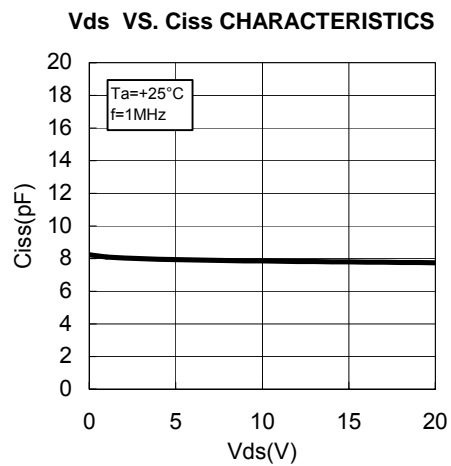
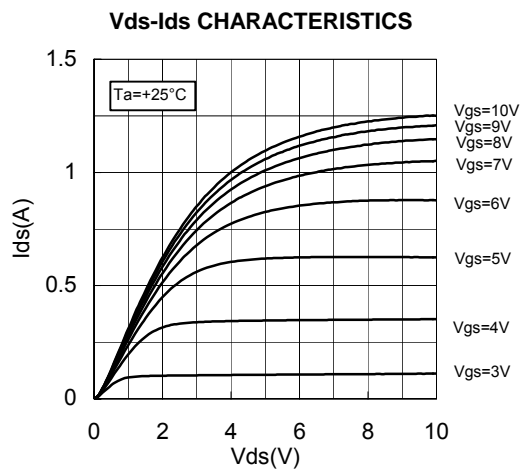
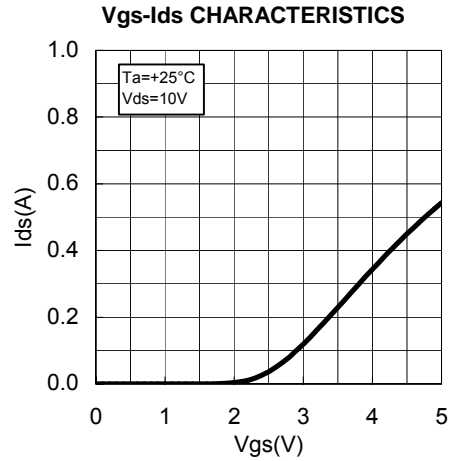
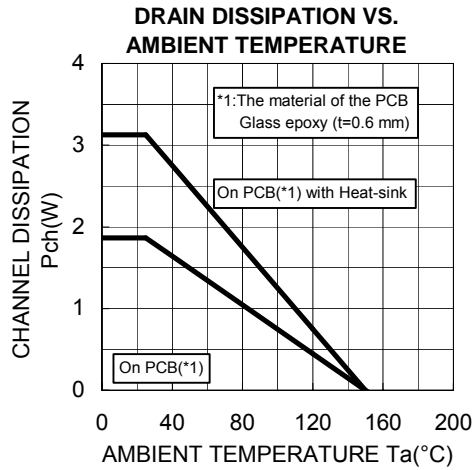

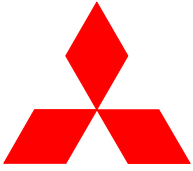

ELECTROSTATIC SENSITIVE DEVICE
OBSERVE HANDLING PRECAUTIONS

MITSUBISHI RF POWER MOS FET

RD00HVS1

RoHS Compliance, Silicon MOSFET Power Transistor 175MHz,0.5W

TYPICAL CHARACTERISTICS

Pin-Po CHARACTERISTICS

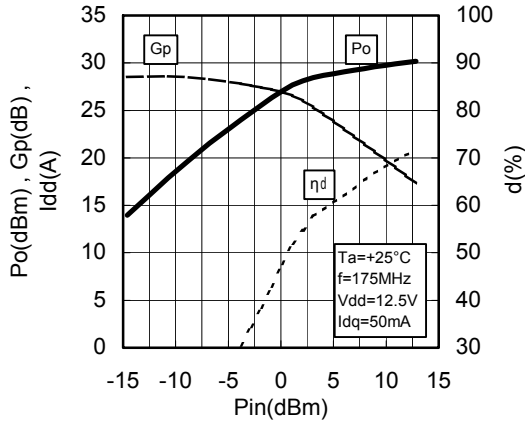

Pin-Po CHARACTERISTICS

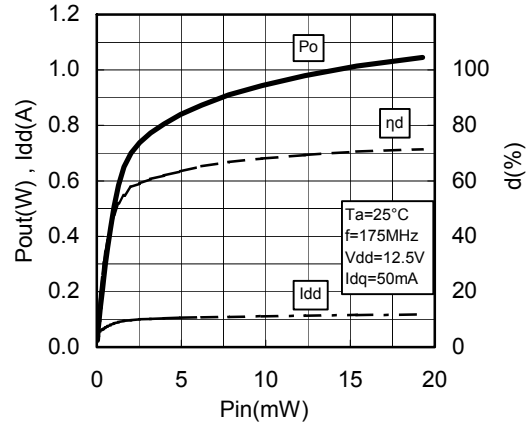

Pin-Po CHARACTERISTICS

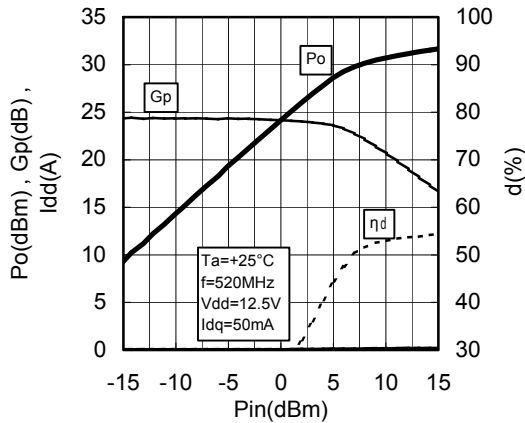

Pin-Po CHARACTERISTICS

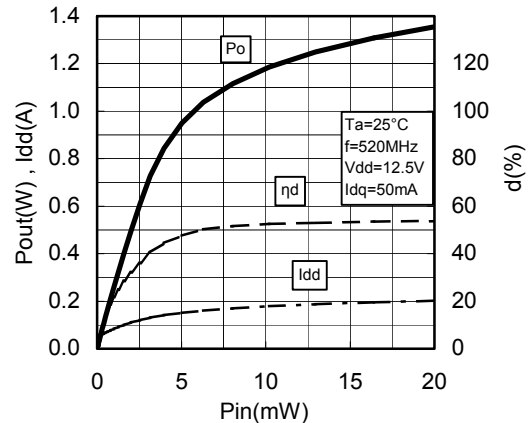

Vdd-Po CHARACTERISTICS

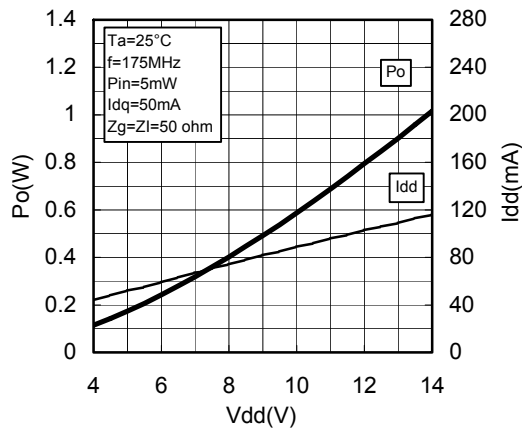

Vdd-Po CHARACTERISTICS

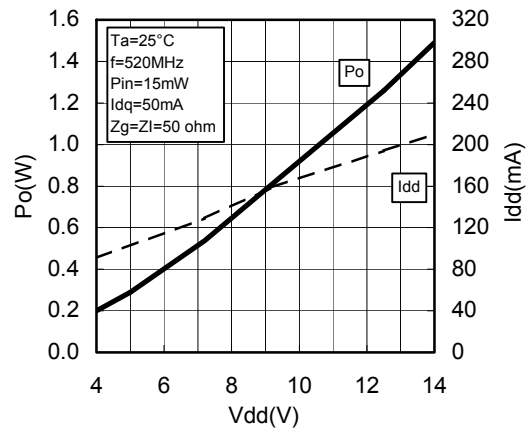

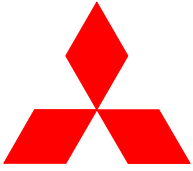

ELECTROSTATIC SENSITIVE DEVICE
OBSERVE HANDLING PRECAUTIONS

MITSUBISHI RF POWER MOS FET

RD00HVS1

RoHS Compliance, Silicon MOSFET Power Transistor 175MHz,0.5W

TEST CIRCUIT(f=175MHz)

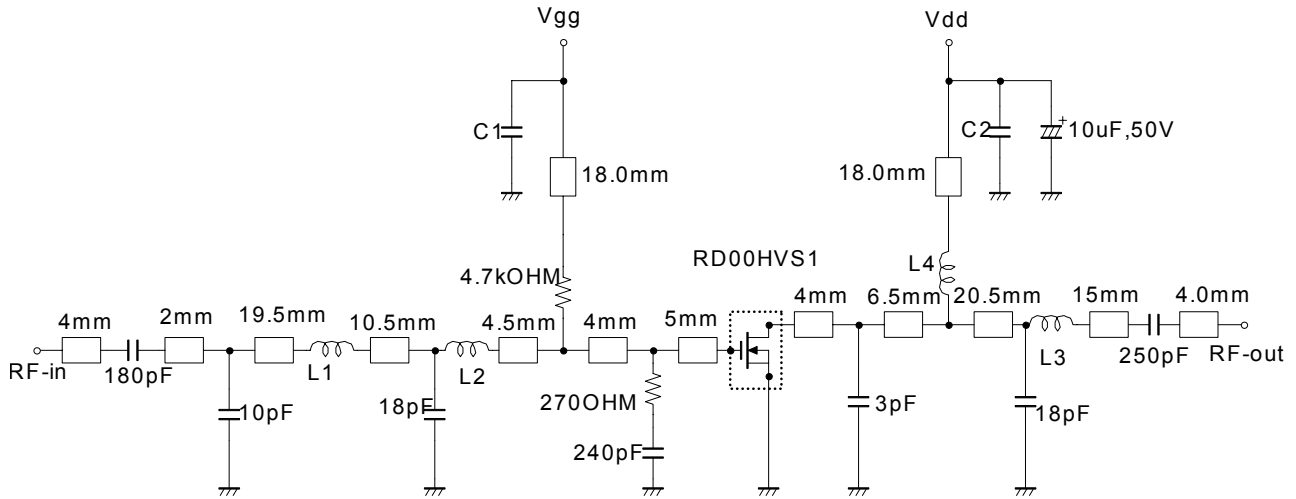

- L1: Enameled wire 4Turns,D:0.43mm,2.46mmO.D
- L2:LQG11A68N(68nH,murata)
- L3: Enameled wire 9Turns,D:0.43mm,2.46mmO.D
- L4: Enameled wire 7Turns,D:0.43mm,2.46mmO.D
- C1,C2:1000pF,0.022uF in parallel

Note:Board material-glass epoxy substrate
Micro strip line width=1.0mm/50 OHM,er:4.8,t=0.6mm

TEST CIRCUIT(f=520MHz)

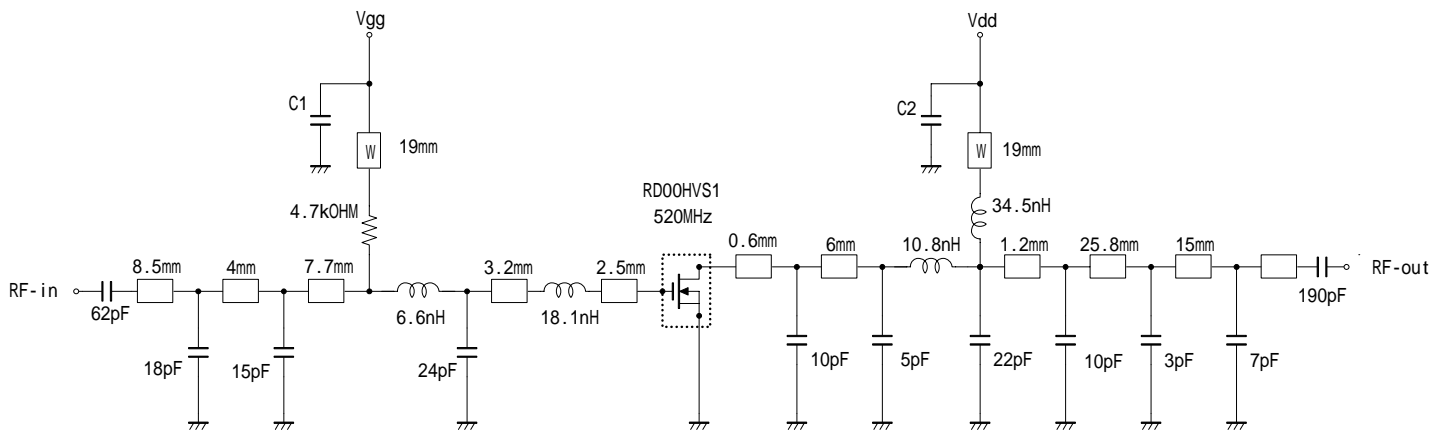

Note: Board material- Glass epoxy copper-clad laminates FR-4
Micro strip line width=1mm,50 OHM, er:4.8, t=0.6mm

C1,C2:1000pF,0.022uF in parallel
W:Line width=1.0mm

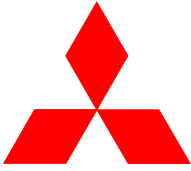

ELECTROSTATIC SENSITIVE DEVICE
OBSERVE HANDLING PRECAUTIONS

MITSUBISHI RF POWER MOS FET

RD00HVS1

RoHS Compliance, Silicon MOSFET Power Transistor 175MHz,0.5W

RD00HVS1 S-PARAMETER DATA (@Vdd=7.2V, Id=50mA)

Freq. [MHz]	S11		S21		S12		S22	
	(mag)	(ang)	(mag)	(ang)	(mag)	(ang)	(mag)	(ang)
100	1.004	-35.2	13.480	158.7	0.027	66.7	0.928	-24.7
150	0.987	-51.9	12.911	147.1	0.039	56.1	0.889	-36.5
175	0.972	-59.7	12.500	141.6	0.043	50.7	0.865	-42.0
200	0.957	-67.1	12.035	136.2	0.048	45.6	0.843	-47.2
250	0.929	-80.1	11.030	126.6	0.054	37.5	0.796	-56.4
300	0.898	-91.5	10.055	118.7	0.058	30.2	0.754	-64.4
350	0.875	-101.4	9.157	111.3	0.060	23.7	0.716	-71.5
400	0.857	-110.0	8.322	104.9	0.062	18.2	0.688	-77.6
450	0.844	-117.3	7.642	99.3	0.063	13.3	0.668	-83.4
500	0.831	-124.1	6.991	93.9	0.063	8.5	0.652	-88.7
550	0.824	-130.0	6.432	89.5	0.064	4.8	0.640	-93.3
600	0.815	-135.0	5.963	84.9	0.063	1.1	0.633	-97.9
650	0.810	-139.9	5.480	80.7	0.062	-2.3	0.627	-102.1
700	0.809	-144.1	5.103	77.0	0.061	-5.4	0.626	-105.9
750	0.807	-148.1	4.769	73.1	0.060	-8.6	0.625	-109.6
800	0.806	-151.8	4.420	69.9	0.058	-11.0	0.627	-113.4
850	0.808	-155.1	4.161	66.8	0.056	-13.5	0.630	-116.8
900	0.808	-158.0	3.900	63.1	0.054	-16.2	0.634	-120.0
950	0.810	-161.1	3.639	60.3	0.053	-17.8	0.639	-123.3
1000	0.811	-163.9	3.466	57.7	0.051	-20.0	0.645	-126.4
1050	0.814	-166.5	3.254	54.1	0.048	-22.1	0.654	-129.3
1100	0.817	-168.9	3.045	51.9	0.046	-23.5	0.661	-132.1

RD00HVS1 S-PARAMETER DATA (@Vdd=12.5V, Id=50mA)

Freq. [MHz]	S11		S21		S12		S22	
	(mag)	(ang)	(mag)	(ang)	(mag)	(ang)	(mag)	(ang)
100	1.005	-33.4	13.343	160.0	0.024	68.3	0.898	-22.6
150	0.995	-49.7	12.874	149.0	0.034	57.9	0.865	-33.1
175	0.980	-57.5	12.525	143.6	0.038	53.2	0.845	-38.0
200	0.967	-64.6	12.108	138.3	0.042	47.8	0.826	-42.9
250	0.943	-77.5	11.193	129.0	0.047	39.3	0.781	-51.3
300	0.916	-88.9	10.249	121.2	0.052	32.3	0.743	-58.9
350	0.891	-98.7	9.403	113.9	0.054	26.2	0.709	-65.6
400	0.877	-107.6	8.582	107.3	0.056	20.6	0.681	-71.5
450	0.862	-115.0	7.916	101.9	0.057	15.7	0.661	-77.0
500	0.852	-121.9	7.273	96.4	0.057	11.2	0.644	-82.0
550	0.844	-128.1	6.706	91.9	0.057	7.5	0.633	-86.6
600	0.835	-133.3	6.224	87.3	0.058	3.4	0.625	-91.2
650	0.828	-138.3	5.755	83.0	0.056	0.2	0.619	-95.2
700	0.824	-142.7	5.358	79.3	0.056	-2.5	0.618	-99.0
750	0.823	-146.8	5.024	75.4	0.054	-5.8	0.616	-102.9
800	0.820	-150.6	4.671	72.0	0.053	-8.4	0.615	-106.6
850	0.821	-153.9	4.398	68.9	0.051	-10.5	0.618	-110.1
900	0.822	-157.2	4.134	65.2	0.050	-13.3	0.622	-113.2
950	0.823	-160.2	3.853	62.3	0.048	-15.2	0.628	-116.5
1000	0.822	-163.1	3.677	59.7	0.047	-17.2	0.633	-119.8
1050	0.826	-165.9	3.459	56.3	0.044	-19.5	0.640	-122.9
1100	0.828	-168.4	3.241	53.9	0.042	-20.2	0.646	-125.7

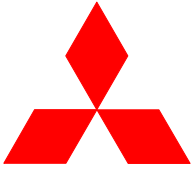

ELECTROSTATIC SENSITIVE DEVICE
OBSERVE HANDLING PRECAUTIONS

mitsubishi RF POWER MOS FET

RD00HVS1

RoHS Compliance, Silicon MOSFET Power Transistor 175MHz,0.5W

—————Keep safety first in your circuit designs! —————

Mitsubishi Electric Corporation puts the maximum effort into making semiconductor products better and more reliable, but there is always the possibility that trouble may occur with them. Trouble with semiconductors may lead to personal injury, fire or property damage. Remember to give due consideration to safety when making your circuit designs, with appropriate measures such as (i) placement of substitutive, auxiliary circuits, (ii) use of non-flammable material or (iii) prevention against any malfunction or mishap.

warning !

Do not use the device at the exceeded the maximum rating condition. In case of plastic molded devices, the exceeded maximum rating condition may cause blowout, smoldering or catch fire of the molding resin due to extreme short current flow between the drain and the source of the device. These results causes in fire or injury.