



ELECTROSTATIC SENSITIVE DEVICE
OBSERVE HANDLING PRECAUTIONS

MITSUBISHI RF POWER MOS FET

RD02MUS2

RoHS Compliance, Silicon MOSFET Power Transistor 175MHz, 520MHz, 2W

DESCRIPTION

RD02MUS2 is a MOS FET type transistor specifically designed for VHF/UHF RF power amplifiers applications. This device has an internal monolithic zener diode from gate to source for ESD protection.

FEATURES

- High power gain:
Pout > 2W, Gp > 16dB
@ Vdd = 7.2V, f = 175MHz, 520MHz
- High Efficiency: 65% typ. (175MHz)
- High Efficiency: 65% typ. (520MHz)
- Integrated gate protection diode

APPLICATION

For output stage of high power amplifiers
In VHF/UHF band mobile radio sets.

OUTLINE DRAWING

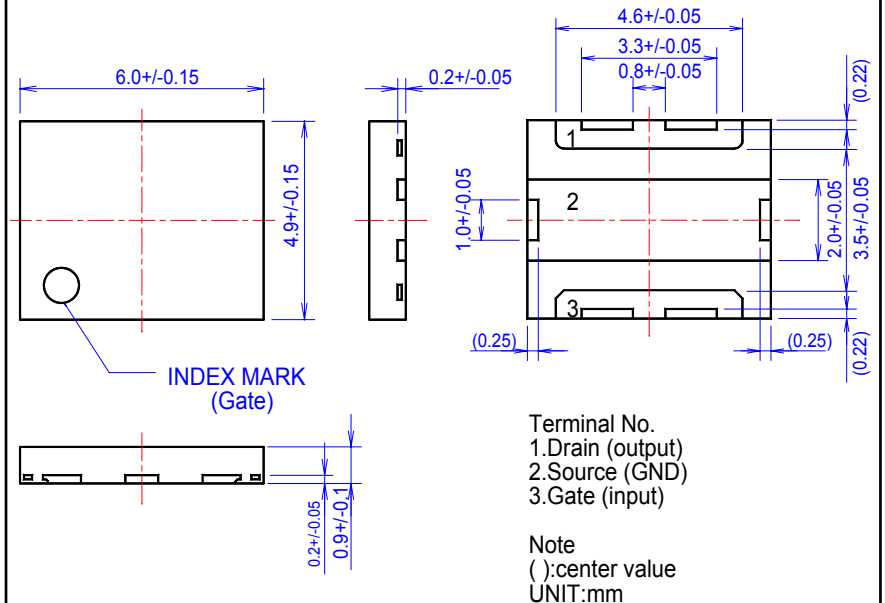

RoHS COMPLIANT

RD02MUS2-101, T112 is a RoHS compliant product.

RoHS compliance is indicated by the letter "G" after the Lot Marking.

This product includes lead in high melting temperature type solders.

However, it is applicable to the following exceptions of RoHS Directives.

1. Lead in high melting temperature type solders (i.e. tin-lead solder alloys containing more than 85% lead.)



ELECTROSTATIC SENSITIVE DEVICE
OBSERVE HANDLING PRECAUTIONS

MITSUBISHI RF POWER MOS FET

RD02MUS2

RoHS Compliance, Silicon MOSFET Power Transistor 175MHz, 520MHz, 2W

ABSOLUTE MAXIMUM RATINGS

(Tc=25°C UNLESS OTHERWISE NOTED)

SYMBOL	PARAMETER	CONDITIONS	RATINGS	UNIT
VDSS	Drain to source voltage	Vgs=0V	30	V
VGSS	Gate to source voltage	Vds=0V	-5/+10	V
Pch	Channel dissipation	Tc=25°C	21.9	W
Pin	Input Power	Zg=Zl=50Ω	0.1	W
ID	Drain Current	-	1.5	A
Tch	Junction temperature	-	150	°C
Tstg	Storage temperature	-	-40 to +125	°C
Rth j-c	Thermal resistance	Junction to case	5.7	°C/W

SCHEMATIC DRAWING

Note 1: Above parameters are guaranteed independently.

ELECTRICAL CHARACTERISTICS (Tc=25°C, UNLESS OTHERWISE NOTED)

SYMBOL	PARAMETER	CONDITIONS	LIMITS			UNIT
			MIN	TYP	MAX.	
Idss	Zero gate Voltage drain current	Vds=17V, Vgs=0V	-	-	100	uA
Igss	Gate to source leak current	VGS=10V, VDS=0V	-	-	1	uA
Vth	Gate threshold Voltage	VDS=12V, IDS=1mA	1	1.8	3	V
Pout1	Output power	VDD=7.2V, Pin=50mW, f=175MHz Idq=200mA	2	3	-	W
ηD1	Drain efficiency		55	65	-	%
Pout2	Output power	VDD=7.2V, Pin=50mW, f=520MHz Idq=200mA	2	3	-	W
ηD2	Drain efficiency		50	65	-	%
	Load VSWR tolerance	VDD=9.2V, Po=2W(Pin Control) f=175MHz, Idq=200mA, Zg=50Ω Load VSWR=20:1(All Phase)	No destroy			-
	Load VSWR tolerance	VDD=9.2V, Po=2W(Pin Control) f=520MHz, Idq=200mA, Zg=50Ω Load VSWR=20:1(All Phase)	No destroy			-

Note : Above parameters , ratings , limits and conditions are subject to change.

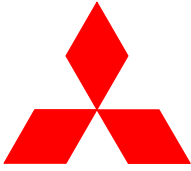

ELECTROSTATIC SENSITIVE DEVICE
OBSERVE HANDLING PRECAUTIONS

MITSUBISHI RF POWER MOS FET

RD02MUS2

RoHS Compliance, Silicon MOSFET Power Transistor 175MHz, 520MHz, 2W

TYPICAL CHARACTERISTICS

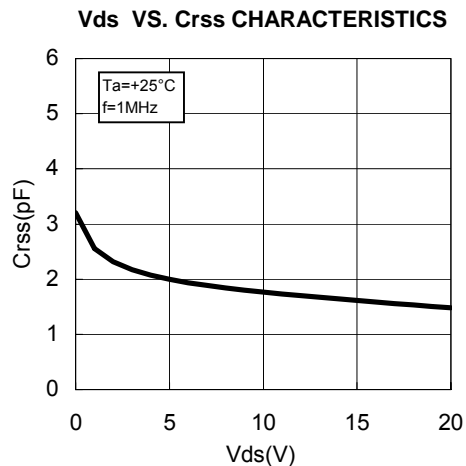
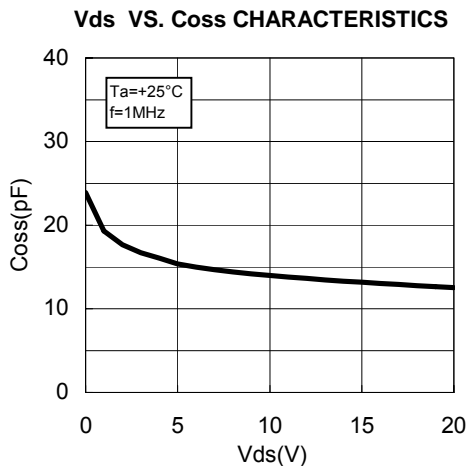
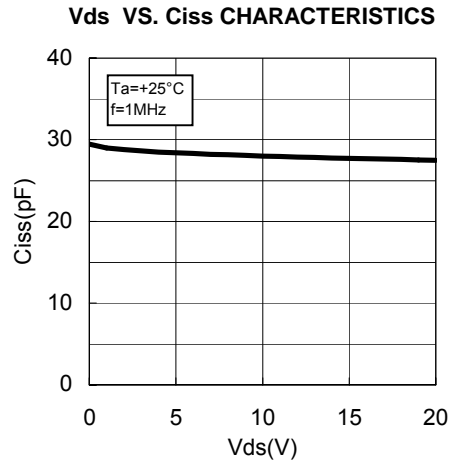
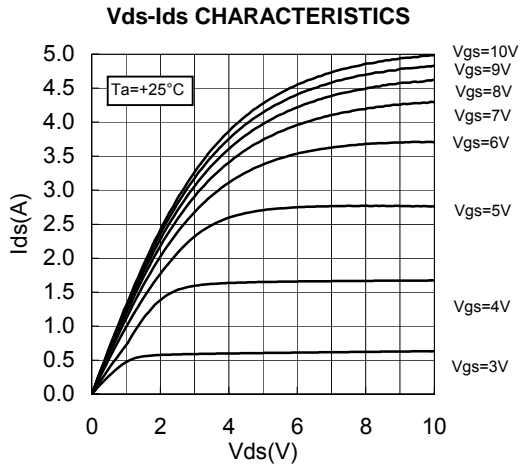
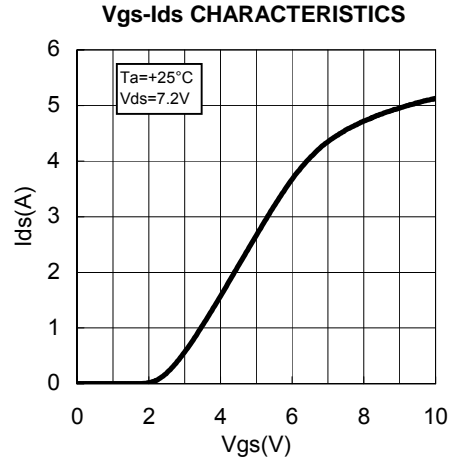
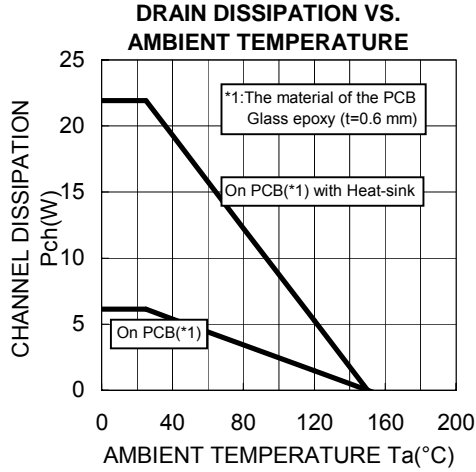

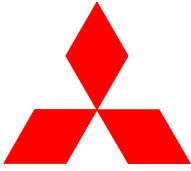

ELECTROSTATIC SENSITIVE DEVICE
OBSERVE HANDLING PRECAUTIONS

MITSUBISHI RF POWER MOS FET

RD02MUS2

RoHS Compliance, Silicon MOSFET Power Transistor 175MHz, 520MHz, 2W

TYPICAL CHARACTERISTICS

Pin-Po CHARACTERISTICS
@f=175MHz

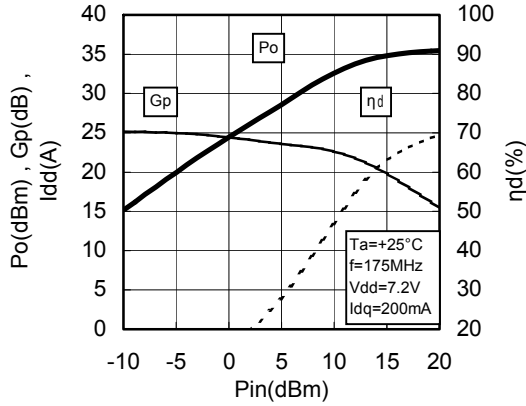

Pin-Po CHARACTERISTICS
@f=175MHz

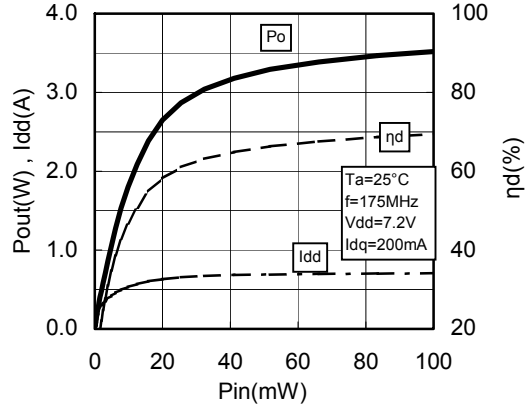

Pin-Po CHARACTERISTICS
@f=520MHz

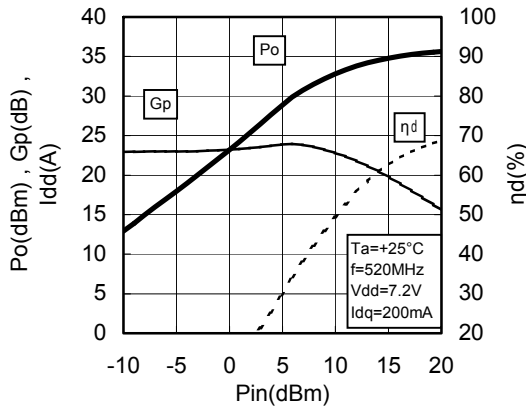

Pin-Po CHARACTERISTICS
@f=520MHz

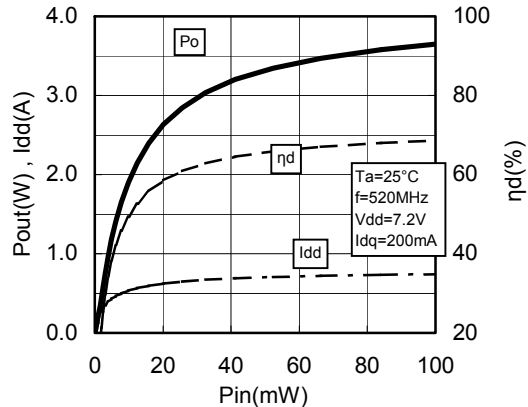

Vdd-Po CHARACTERISTICS
@f=175MHz

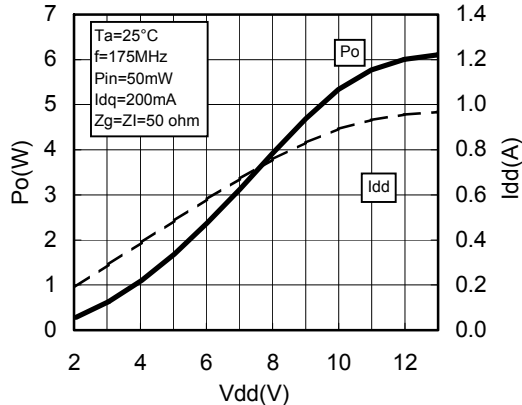

Vdd-Po CHARACTERISTICS
@f=520MHz

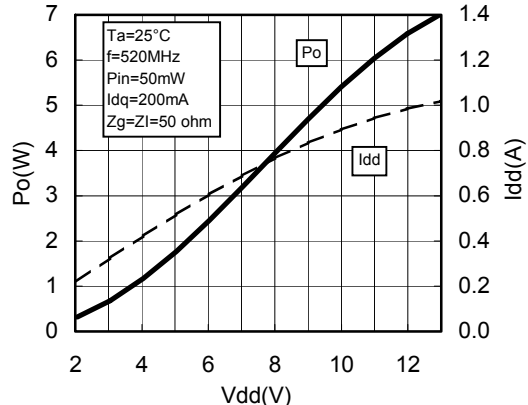

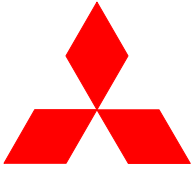

ELECTROSTATIC SENSITIVE DEVICE
OBSERVE HANDLING PRECAUTIONS

MITSUBISHI RF POWER MOS FET

RD02MUS2

RoHS Compliance, Silicon MOSFET Power Transistor 175MHz, 520MHz, 2W

TYPICAL CHARACTERISTICS

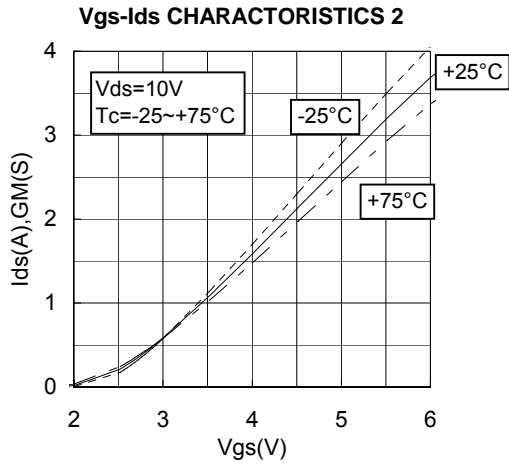



ELECTROSTATIC SENSITIVE DEVICE
OBSERVE HANDLING PRECAUTIONS

MITSUBISHI RF POWER MOS FET

RD02MUS2

RoHS Compliance, Silicon MOSFET Power Transistor 175MHz, 520MHz, 2W

TEST CIRCUIT(f=175MHz)

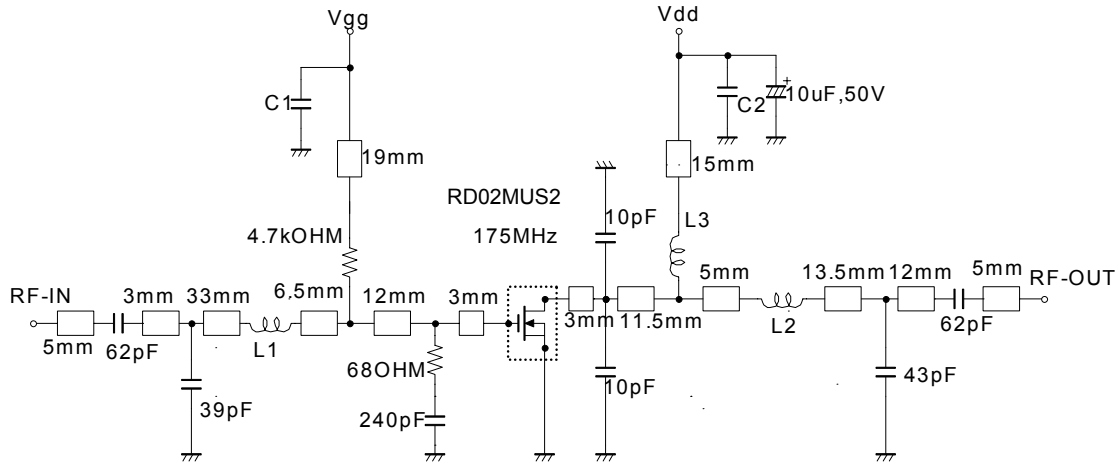

L1: Enameled wire 5Turns, D:0.43mm, 2.46mm O.D
L2: Enameled wire 3Turns, D:0.43mm, 2.46mm O.D
L3: Enameled wire 9Turns, D:0.43mm, 2.46mm O.D
C1, C2: 1000pF, 0.0022uF in parallel

Note: Board material-Teflon substrate
Micro strip line width=2.2mm/50OHM, er:2.7, t=0.8mm

TEST CIRCUIT(f=520MHz)

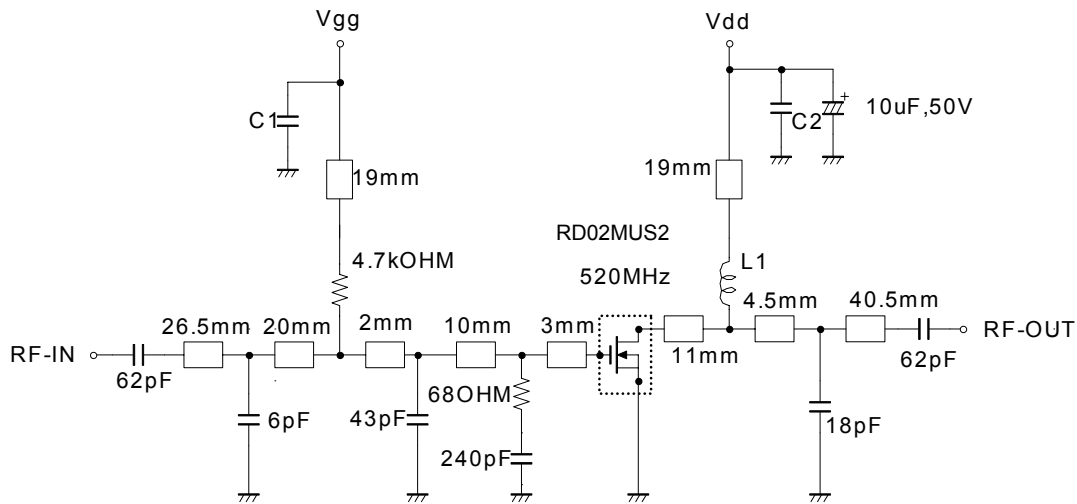

L1: Enameled wire 9Turns, D:0.43mm, 2.46mm O.D
C1, C2: 1000pF, 0.022uF in parallel

Note: Board material-Teflon substrate
Micro strip line width=2.2mm/50OHM, er:2.7, t=0.8mm



ELECTROSTATIC SENSITIVE DEVICE
OBSERVE HANDLING PRECAUTIONS

MITSUBISHI RF POWER MOS FET

RD02MUS2

RoHS Compliance, Silicon MOSFET Power Transistor 175MHz, 520MHz, 2W

INPUT/OUTPUT IMPEDANCE VS. FREQUENCY CHARACTERISTICS

175MHz Z_{in}^* Z_{out}^*
 $Z_o=50\Omega$

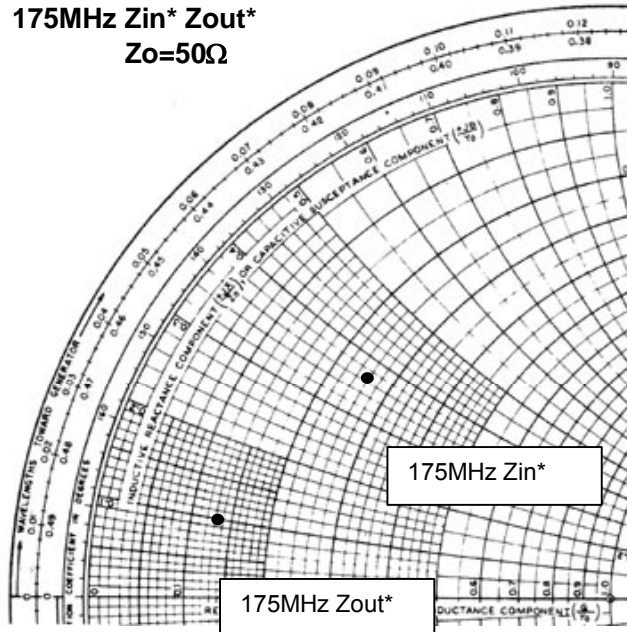

Vdd=7.2V, Idq=200mA(Vgg adj.), Pin=0.05W

$Z_{in}^*=11.61+j17.88$
 $Z_{out}^*=6.83+j5.21$

Z_{in}^* : Complex conjugate of input impedance
 Z_{out}^* : Complex conjugate of input impedance

520MHz Z_{in}^* Z_{out}^*
 $Z_o=50\Omega$

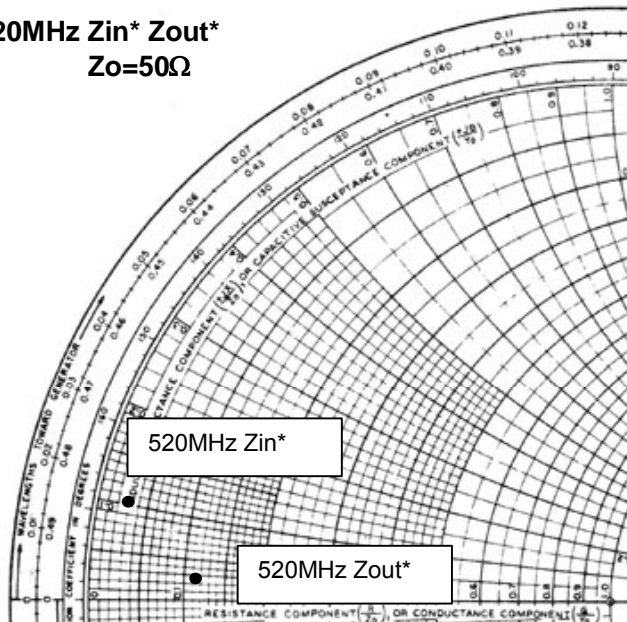

Vdd=7.2V, Idq=200mA(Vgg adj.), Pin=0.05W

$Z_{in}^*=1.20+j5.47$
 $Z_{out}^*=5.56+j1.31$

Z_{in}^* : Complex conjugate of input impedance
 Z_{out}^* : Complex conjugate of input impedance



ELECTROSTATIC SENSITIVE DEVICE
OBSERVE HANDLING PRECAUTIONS

MITSUBISHI RF POWER MOS FET

RD02MUS2

RoHS Compliance, Silicon MOSFET Power Transistor 175MHz, 520MHz, 2W

RD02MSU2 S-PARAMETER DATA (@Vdd=7.2V, Id=200mA)

Freq. [MHz]	S11		S21		S12		S22	
	(mag)	(ang)	(mag)	(ang)	(mag)	(ang)	(mag)	(ang)
100	0.827	-137.1	16.666	99.9	0.038	10.7	0.571	-126.8
150	0.819	-151.1	11.358	88.9	0.039	1.0	0.561	-139.9
175	0.816	-155.3	9.733	84.7	0.039	-3.4	0.565	-143.5
200	0.813	-158.5	8.455	81.1	0.040	-5.7	0.573	-146.3
250	0.819	-163.4	6.704	74.4	0.037	-12.7	0.586	-149.9
300	0.823	-166.9	5.469	68.6	0.036	-17.0	0.604	-152.6
350	0.832	-169.4	4.593	63.6	0.036	-22.1	0.626	-154.8
400	0.836	-171.5	3.904	58.8	0.034	-26.4	0.646	-156.6
450	0.841	-173.2	3.362	54.3	0.033	-29.9	0.669	-158.2
500	0.851	-174.9	2.941	50.1	0.032	-33.6	0.690	-159.6
520	0.854	-175.5	2.793	48.5	0.032	-34.5	0.697	-160.2
550	0.857	-176.4	2.572	46.2	0.031	-35.7	0.710	-161.1
600	0.864	-177.7	2.298	42.8	0.028	-39.1	0.732	-162.5
650	0.869	-179.1	2.041	39.1	0.028	-41.1	0.745	-163.7
700	0.878	-179.6	1.836	35.8	0.026	-43.6	0.762	-165.3
750	0.882	-178.7	1.652	32.9	0.024	-46.5	0.779	-166.5
800	0.888	-177.6	1.490	30.1	0.023	-49.7	0.788	-167.9
850	0.893	-176.4	1.357	27.1	0.022	-54.7	0.802	-168.9
900	0.894	-175.5	1.232	24.9	0.019	-52.1	0.813	-170.0
950	0.899	-174.7	1.131	22.8	0.019	-54.9	0.823	-171.3
1000	0.903	-173.8	1.043	20.2	0.017	-55.3	0.835	-172.0
1050	0.907	-172.9	0.957	18.5	0.016	-56.1	0.844	-173.1
1100	0.909	-172.1	0.882	16.3	0.015	-54.1	0.853	-173.9

RD02MSU2 S-PARAMETER DATA (@Vdd=12.5V, Id=200mA)

Freq. [MHz]	S11		S21		S12		S22	
	(mag)	(ang)	(mag)	(ang)	(mag)	(ang)	(mag)	(ang)
100	0.844	-132.5	17.379	102.5	0.037	12.8	0.541	-122.6
150	0.832	-147.7	11.947	91.0	0.037	2.1	0.533	-136.2
175	0.829	-152.5	10.288	86.5	0.037	-1.8	0.538	-140.2
200	0.830	-156.2	8.975	82.5	0.037	-4.7	0.541	-143.1
250	0.832	-161.5	7.098	75.9	0.037	-12.5	0.559	-147.2
300	0.836	-165.3	5.821	70.1	0.036	-17.0	0.578	-149.8
350	0.841	-168.3	4.863	64.7	0.034	-21.0	0.601	-151.9
400	0.849	-170.6	4.167	59.9	0.034	-25.3	0.624	-153.9
450	0.853	-172.8	3.597	55.1	0.032	-28.8	0.648	-155.3
500	0.861	-174.6	3.139	50.9	0.030	-31.6	0.669	-156.9
520	0.859	-175.3	2.965	49.2	0.030	-34.7	0.677	-157.6
550	0.865	-176.1	2.759	46.9	0.028	-35.4	0.691	-158.3
600	0.869	-177.5	2.440	43.3	0.028	-39.0	0.710	-159.9
650	0.877	-178.9	2.179	39.7	0.026	-41.6	0.729	-161.4
700	0.881	-179.9	1.958	36.7	0.024	-43.3	0.745	-162.9
750	0.890	-178.9	1.772	33.5	0.023	-46.6	0.765	-164.2
800	0.894	-177.9	1.597	30.8	0.022	-47.9	0.777	-165.4
850	0.897	-176.6	1.448	28.2	0.020	-48.2	0.790	-166.8
900	0.902	-175.7	1.331	25.4	0.018	-48.2	0.800	-167.9
950	0.905	-174.7	1.212	23.3	0.018	-50.7	0.814	-169.2
1000	0.910	-174.0	1.110	20.8	0.017	-52.3	0.825	-170.3
1050	0.913	-173.1	1.026	18.8	0.015	-55.2	0.834	-171.4
1100	0.914	-172.4	0.953	16.7	0.014	-56.5	0.843	-172.1

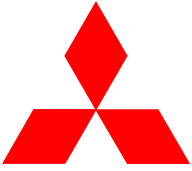

ELECTROSTATIC SENSITIVE DEVICE
OBSERVE HANDLING PRECAUTIONS

MITSUBISHI RF POWER MOS FET

RD02MUS2

RoHS Compliance, Silicon MOSFET Power Transistor 175MHz, 520MHz, 2W

Keep safety first in your circuit designs!

Mitsubishi Electric Corporation puts the maximum effort into making semiconductor products better and more reliable, but there is always the possibility that trouble may occur with them. Trouble with semiconductors may lead to personal injury, fire or property damage. Remember to give due consideration to safety when making your circuit designs, with appropriate measures such as (i) placement of substitutive, auxiliary circuits, (ii) use of non-flammable material or (iii) prevention against any malfunction or mishap.

warning !

Do not use the device at the exceeded the maximum rating condition. In case of plastic molded devices, the exceeded maximum rating condition may cause blowout, smoldering or catch fire of the molding resin due to extreme short current flow between the drain and the source of the device. These results causes in fire or injury.