

### Bias Resistor Transistor PNP Silicon

 Lead(Pb)-Free

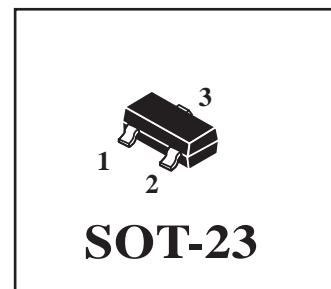
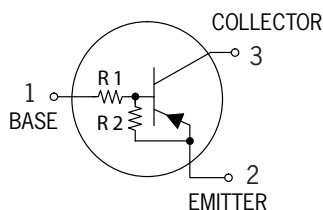

### Maximum Ratings (T<sub>A</sub>=25°C unless otherwise noted)

Rating	Symbol	Value	Unit
Collector-Emitter Voltage	V <sub>CEO</sub>	50	Vdc
Collector-Base Voltage	V <sub>CBO</sub>	50	Vdc
Collector Current-Continuous	I <sub>C</sub>	100	mAdc

### Thermal Characteristics

Characteristics	Symbol	Max	Unit
Total Device Dissipation FR-5 Board (1)T <sub>A</sub> =25°C Derate above 25°C	P <sub>D</sub>	246 (1)	mW
		400 (2)	
		1.5 (1)	mW/°C
		2.0 (2)	
Thermal Resistance, Junction to Ambient	R <sub>θJA</sub>	508 311	°C/W
Junction and Storage, Temperature Range	T <sub>J</sub> ,T <sub>stg</sub>	-55 to +150	°C

1.FR-4 @ minimum pad

2.FR-4 @ 1.0×1.0 inch Pad

### Device Marking and Resistor Values

Device	Marking	R1(K)	R2(K)	Device	Marking	R1(K)	R2(K)
MMUN2111	A6A	10	10	MMUN2130	A6G	1.0	1.0
MMUN2112	A6B	22	22	MMUN2131	A6H	2.2	2.2
MMUN2113	A6C	47	47	MMUN2132	A6J	4.7	4.7
MMUN2114	A6D	10	47	MMUN2133	A6K	4.7	47
MMUN2115	A6E	10	∞	MMUN2134	A6L	22	47
MMUN2116	A6F	4.7	∞				

**Electrical Characteristics** (TA=25°C Unless Otherwise noted)

Characteristics	Symbol	Min	Typ	Max	Unit
-----------------	--------	-----	-----	-----	------

**Off Characteristics**

Collector-Emitter Breakdown Voltage ( $I_C=2.0\text{mA}$ , $I_B=0$ )	V(BR)CEO	50	-	-	V
Collector-Base Breakdown Voltage ( $I_C=10\text{ }\mu\text{A}$ , $I_E=0$ )	V(BR)CBO	50	-	-	V
Collector-Base Cutoff Voltage ( $V_{CB}=50\text{V}$ , $I_E=0$ )	ICBO	-	-	100	nA
Collector-Emitter Cutoff Current ( $V_{CE}=50\text{V}$ , $I_B=0$ )	ICEO	-	-	500	nA
Emitter-Base Cutoff Current ( $V_{EB}=6.0\text{V}$ , $I_C=0$ )	IEBO	-	-	0.5	mA
MMUN2111		-	-	0.2	
MMUN2112		-	-	0.1	
MMUN2113		-	-	0.2	
MMUN2114		-	-	0.9	
MMUN2115		-	-	1.9	
MMUN2116		-	-	4.3	
MMUN2130		-	-	2.3	
MMUN2131		-	-	1.5	
MMUN2132		-	-	0.18	
MMUN2133		-	-	0.13	
MMUN2134		-	-		

**On Characteristics**

Collector-Emitter Saturation Voltage ( $I_C=10\text{mA}$ , $I_B=0.3\text{mA}$ ) ( $I_C=10\text{mA}$ , $I_B=5\text{mA}$ ) MMUN2130/MMUN2131 ( $I_C=10\text{mA}$ , $I_B=1\text{mA}$ ) MMUN2115/MMUN2116 MMUN2132/MMUN2133/MMUN2134	VCE(sat)	-	-	0.25	Vdc
--	----------	---	---	------	-----

3. Pulse Test: Pulse Width < 300 us, Duty Cycle < 2.0%

**Electrical Characteristics** (TA=25°C Unless Otherwise noted)

Characteristics	Symbol	Min	Typ	Max	Unit
-----------------	--------	-----	-----	-----	------

**On Characteristics** (3)

DC Current Gain (VCE=10V, IC=5.0mA)	MMUN2111 MMUN2112 MMUN2113 MMUN2114 MMUN2115 MMUN2116 MMUN2130 MMUN2131 MMUN2132 MMUN2133 MMUN2134	hFE	35 60 80 80 160 160 3.0 8.0 15 80 80	60 100 140 140 250 250 5.0 15 27 140 130	- - - - - - - - - - -	
Output Voltage(on) (VCC=5.0V, VB=2.5V, RL=1.0kΩ)  (VCC=5.0V, VB=3.5V, RL=1.0kΩ)	MMUN2111 MMUN2112 MMUN2114 MMUN2115 MMUN2116 MMUN2130 MMUN2131 MMUN2132 MMUN2133 MMUN2134 MMUN2113	VOL	- - - - - - - - - - -	- - - - - - - - - - -	0.2 0.2 0.2 0.2 0.2 0.2 0.2 0.2 0.2 0.2 0.2	Vdc
Output Voltage(off) (VCC=5.0V, VB=0.5V, RL=1.0kΩ) (VCC=5.0V, VB=0.25V, RL=1.0kΩ)  (VCC=5.0V, VB=0.050V, RL=1.0kΩ)	MMUN2115 MMUN2116 MMUN2131 MMUN2132 MMUN2130	VOH	4.9	-	-	Vdc

3. Pulse Test: Pulse Width<300 us, Duty Cycle<2.0%

## Electrical Characteristics (TA=25°C Unless Otherwise noted)

Characteristics	Symbol	Min	Typ	Max	Unit
-----------------	--------	-----	-----	-----	------

### On Characteristics

Input Resistor	MMUN2111	R1	7.0	10	13	kΩ
	MMUN2112		15.4	22	28.6	
	MMUN2113		32.9	47	61.1	
	MMUN2114		7.0	10	13	
	MMUN2115		7.0	10	13	
	MMUN2116		3.3	4.7	6.1	
	MMUN2130		0.7	1.0	1.3	
	MMUN2131		1.5	2.2	2.9	
	MMUN2132		3.3	4.7	6.1	
	MMUN2133		3.3	4.7	6.1	
	MMUN2134		15.4	22	28.6	
	Resistor Ratio MMUNM2111/MMUN2112/MMUN2113		R1/R2	0.8	1.0	
MMUN2114	0.17	0.21		0.25		
MMUN2115/MMUN2116	-	-		-		
MMUN2130/MMUN2131/MMUN2132	0.8	1.0		1.2		
MMUN2133	0.055	0.1		0.185		

4. Pulse Test: Pulse Width < 300 us, Duty Cycle < 2.0 %

MMUN2111 Series  
**TYPICAL ELECTRICAL CHARACTERISTICS**  
 MMUN2114

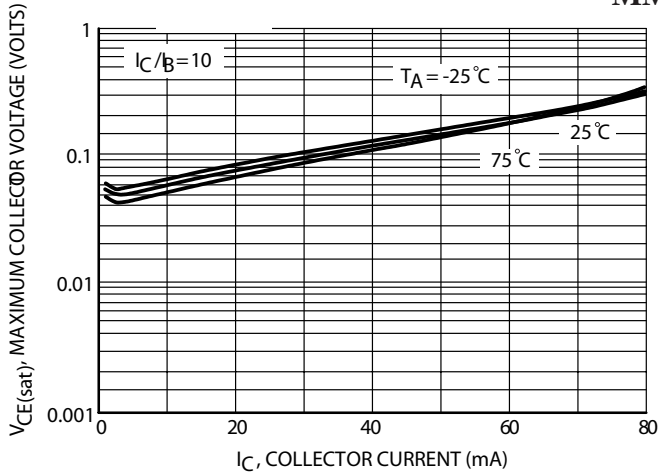

**FIG.1  $V_{CE(sat)}$  versus  $I_C$**

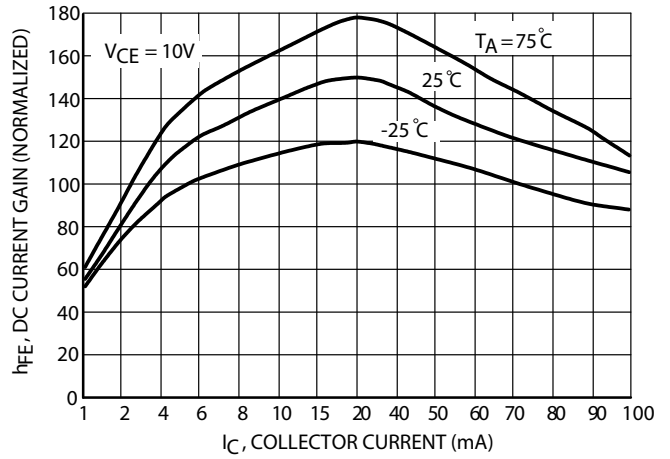

**FIG.2 DC Current Gain**

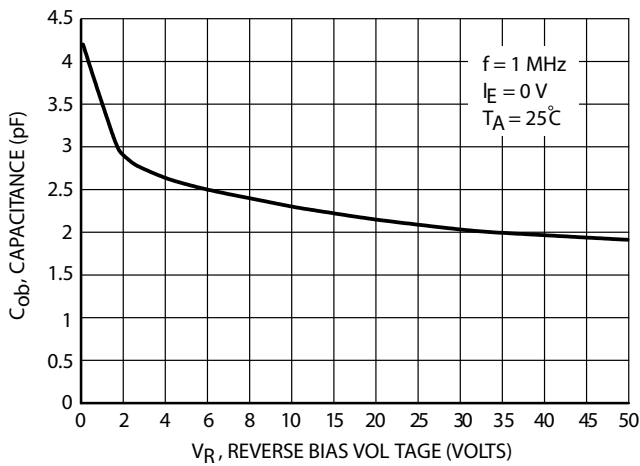

**FIG.3 Output Capacitance**

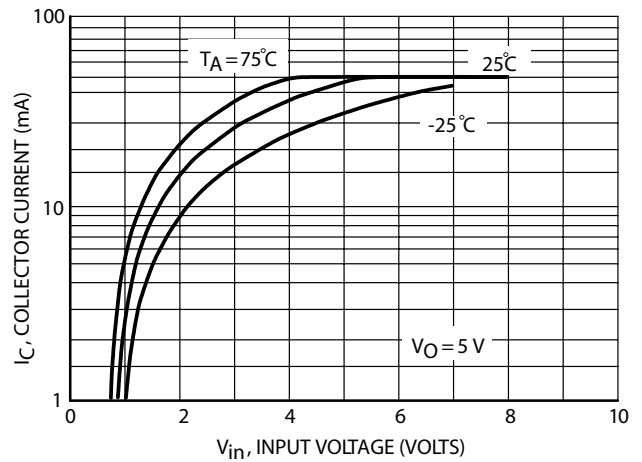

**FIG.4 Output Current versus Input Voltage**

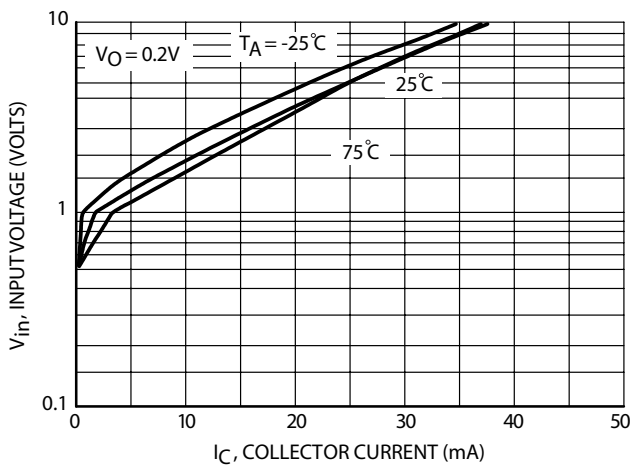

**FIG.5 Input Voltage versus Output Current**

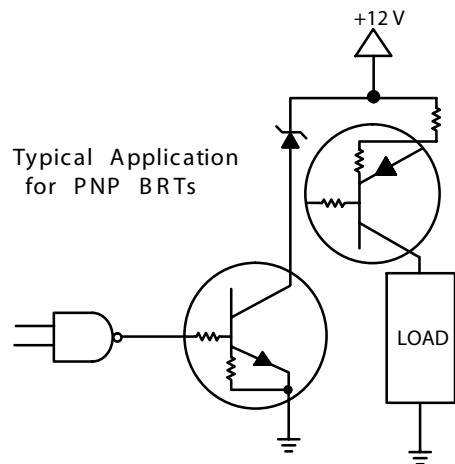

**FIG.6 Inexpensive, Unregulated Current Source**

### SOT-23 Package Outline Dimensions

Unit:mm

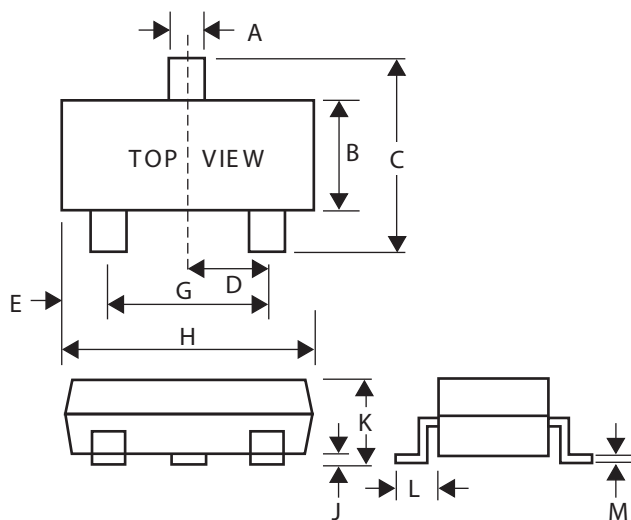

Dim	Min	Max
A	0.35	0.51
B	1.19	1.40
C	2.10	3.00
D	0.85	1.05
E	0.46	1.00
G	1.70	2.10
H	2.70	3.10
J	0.01	0.13
K	0.89	1.10
L	0.30	0.61
M	0.076	0.25