

Description

- Complex type bipolar transistor

Feature

- Very small package save PCB area
- Reduce quantity of parts and mounting cost
- Both DN030 chip and DP030 chip in SOT-563F package

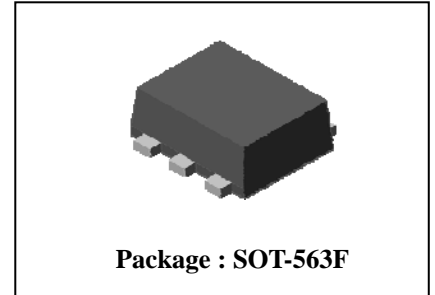

Ordering Information

Type NO.	Marking	Package Code
SUT575EF	NX□	SOT-563F

□ : Year & Week Code

Equivalent circuit & PIN Connections

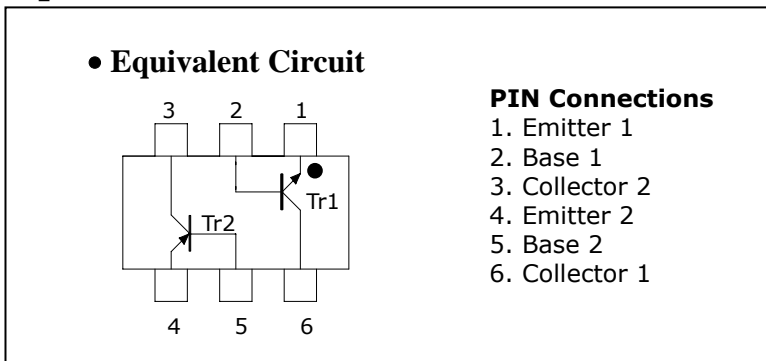

Absolute Maximum Ratings [Tr1, Tr2]

(Ta=25°C)

Characteristic	Symbol	Rating		Unit
		Tr1	Tr2	
Collector-base voltage	V_{CBO}	15	-15	V
Collector-emitter voltage	V_{CEO}	12	-12	V
Emitter-base voltage	V_{EBO}	5	-5	V
Collector current	I_C	500	-500	mA
Collector power dissipation	P_C^{**}	150		mW
Junction temperature	T_J	150		°C
Storage temperature range	T_{stg}	-55~150		°C

※: Total rating

Electrical Characteristics [Tr1]

(Ta=25°C)

Characteristic	Symbol	Test Condition	Min.	Typ.	Max.	Unit
Collector-emitter breakdown voltage	BV_{CEO}	$I_C=1mA, I_B=0$	12	-	-	V
Collector cut-off current	I_{CBO}	$V_{CB}=15V, I_E=0$	-	-	0.1	μA
Emitter cut-off current	I_{EBO}	$V_{EB}=5V, I_C=0$	-	-	0.1	μA
DC current gain	h_{FE}^*	$V_{CE}=2V, I_C=10mA$	200	-	450	-
Collector-emitter saturation voltage	$V_{CE(sat)}$	$I_C=100mA, I_B=10mA$	-	-	0.2	V
	$V_{CE(sat)}^*$	$I_C=300mA, I_B=30mA$	-	-	0.5	V
Base-emitter saturation voltage	$V_{BE(sat)}$	$I_C=100mA, I_B=10mA$	-	-	1.2	V
	$V_{BE(sat)}^*$	$I_C=300mA, I_B=30mA$	-	-	1.7	V
Transition frequency	f_T	$V_{CE}=5V, I_C=10mA$	-	300	-	MHz
Collector output capacitance	C_{ob}	$V_{CB}=10V, I_E=0, f=1MHz$	-	3	-	pF

*: Pulse test: $t_p \leq 300\mu s$, Duty cycle $\leq 2\%$

Electrical Characteristics [Tr2]

(Ta=25°C)

Characteristic	Symbol	Test Condition	Min.	Typ.	Max.	Unit
Collector-emitter breakdown voltage	BV_{CEO}	$I_C=-1mA, I_B=0$	-12	-	-	V
Collector cut-off current	I_{CBO}	$V_{CB}=-15V, I_E=0$	-	-	-0.1	μA
Emitter cut-off current	I_{EBO}	$V_{EB}=-5V, I_C=0$	-	-	-0.1	μA
DC current gain	h_{FE}^*	$V_{CE}=-2V, I_C=-10mA$	200	-	450	-
Collector-emitter saturation voltage	$V_{CE(sat)}$	$I_C=-100mA, I_B=-10mA$	-	-	-0.2	V
	$V_{CE(sat)}^*$	$I_C=-300mA, I_B=-30mA$	-	-	-0.5	V
Base-emitter saturation voltage	$V_{BE(sat)}$	$I_C=-100mA, I_B=-10mA$	-	-	-1.2	V
	$V_{BE(sat)}^*$	$I_C=-300mA, I_B=-30mA$	-	-	-1.7	V
Transition frequency	f_T	$V_{CE}=-5V, I_C=-10mA$	-	350	-	MHz
Collector output capacitance	C_{ob}	$V_{CB}=-10V, I_E=0, f=1MHz$	-	4	-	pF

*: Pulse test: $t_p \leq 300\mu s$, Duty cycle $\leq 2\%$

Electrical Characteristic Curves

[Tr1]

Fig. 1 $I_C - V_{CE}$

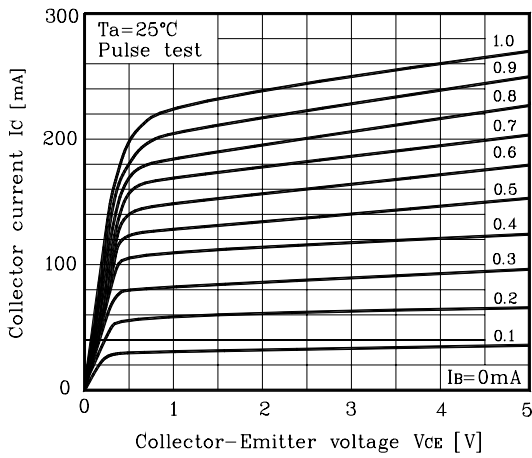

Fig. 2 $I_C - V_{BE}$

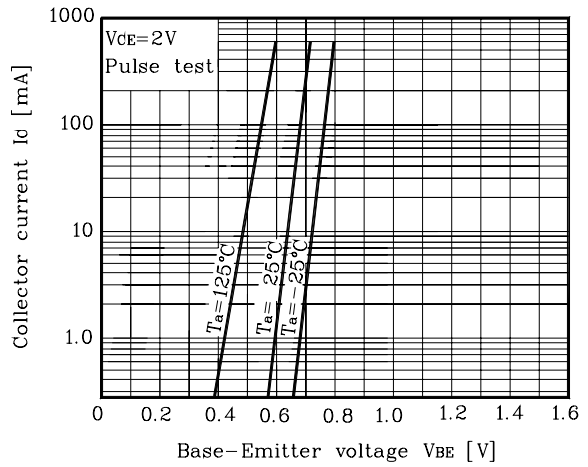

Fig. 3 $h_{FE} - I_C$

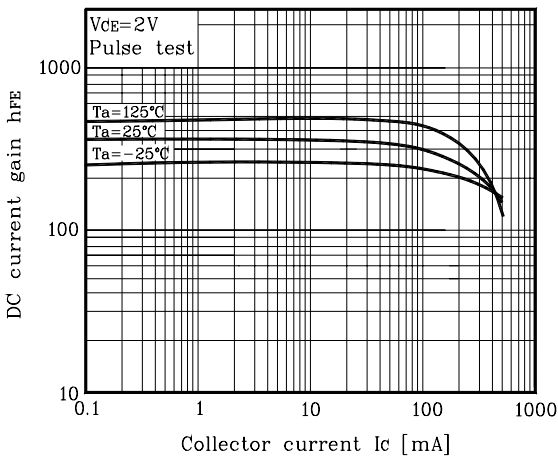
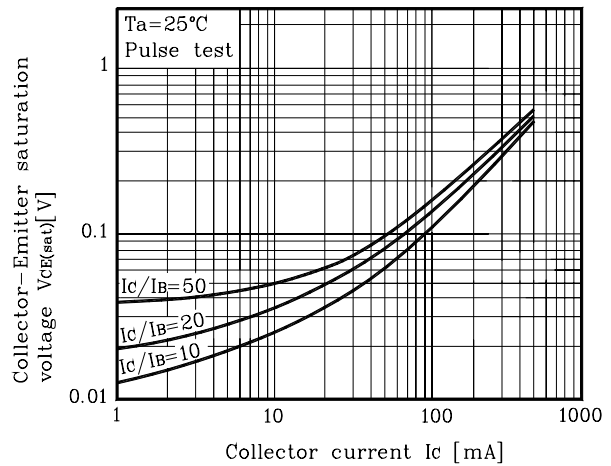

Fig. 4 $V_{CE(sat)} - I_C$



Electrical Characteristic Curves

[Tr2]

Fig. 1 $I_C - V_{CE}$

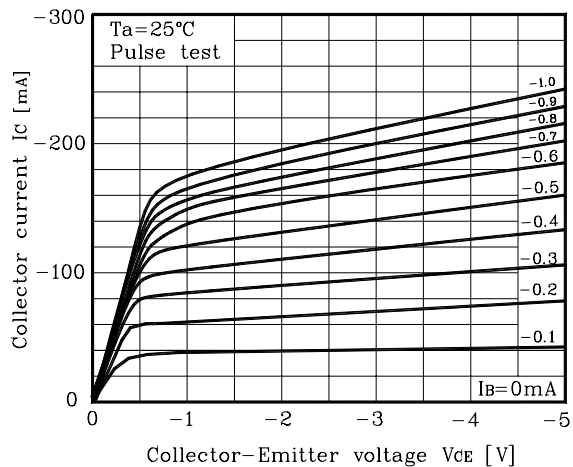

Fig. 2 $I_C - V_{BE}$

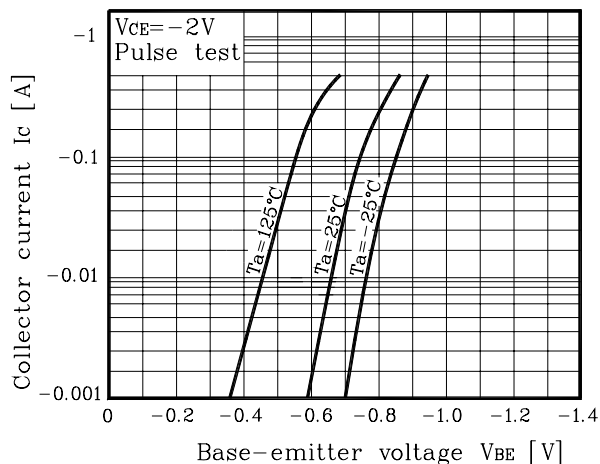

Fig. 3 $h_{FE} - I_C$

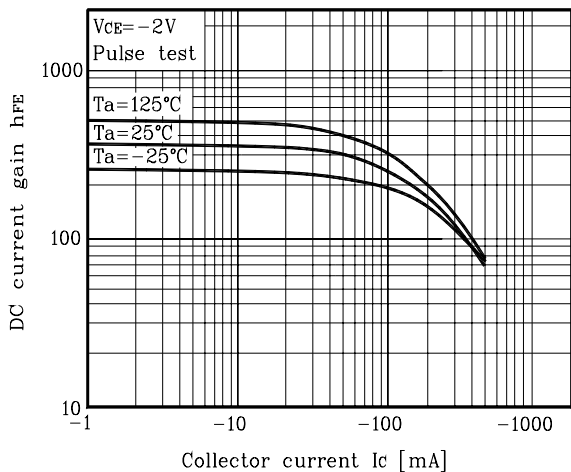
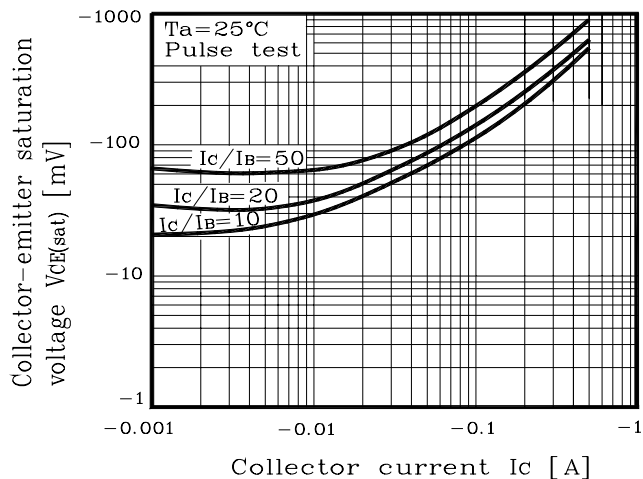
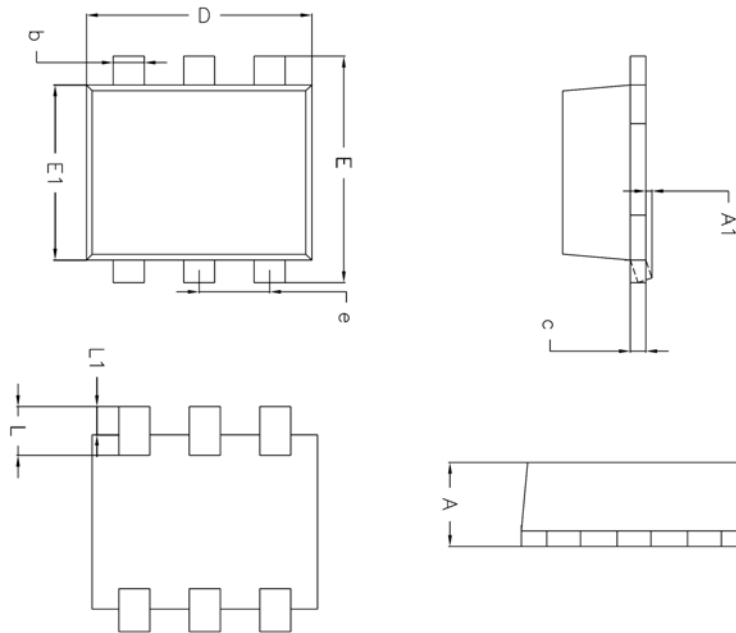

Fig. 4 $V_{CE(sat)} - I_C$



Outline Dimension



SYMBOL	MILLIMETERS			NOTE
	MINIMUM	NOMINAL	MAXIMUM	
A	0.53	0.58	0.62	
A1	0.00	—	0.10	
A2	—	—	—	
b	0.15	0.20	0.30	
c	0.10	0.11	0.18	
D	1.50	1.60	1.70	
E	1.50	1.60	1.70	
E1	1.10	1.20	1.30	
e	0.50 BSC			
L	0.25	0.35	0.45	
L1	0.13	0.20	0.27	

※ Recommend PCB solder land [Unit: mm]

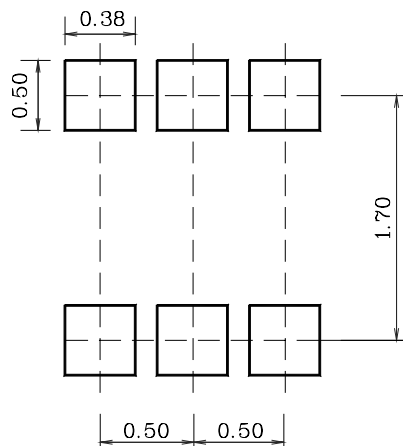

The AUK Corp. products are intended for the use as components in general electronic equipment (Office and communication equipment, measuring equipment, home appliance, etc.).

Please make sure that you consult with us before you use these AUK Corp. products in equipments which require high quality and / or reliability, and in equipments which could have major impact to the welfare of human life(atomic energy control, airplane, spaceship, transportation, combustion control, all types of safety device, etc.). AUK Corp. cannot accept liability to any damage which may occur in case these AUK Corp. products were used in the mentioned equipments without prior consultation with AUK Corp..

Specifications mentioned in this publication are subject to change without notice.