

## Descriptions

- Complex type bipolar transistor

## Features

- Reduce quantity of parts and mounting cost
- High collector power dissipation :  $P_C=300\text{mW}(\text{Max.})$
- Both 2SA1980 chip and 2SC5343 chip in SOT-26 Package

## Ordering Information

Type NO.	Marking	Package Code
SUT462N	3X□	SOT-26

□ : Year & Week Code

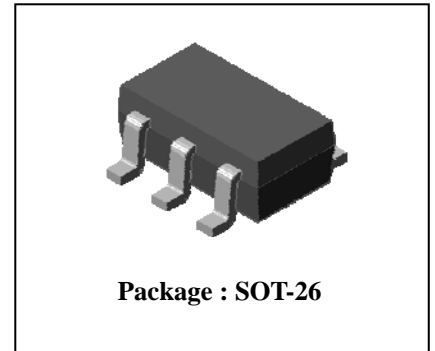

## Equivalent circuit & PIN Connections

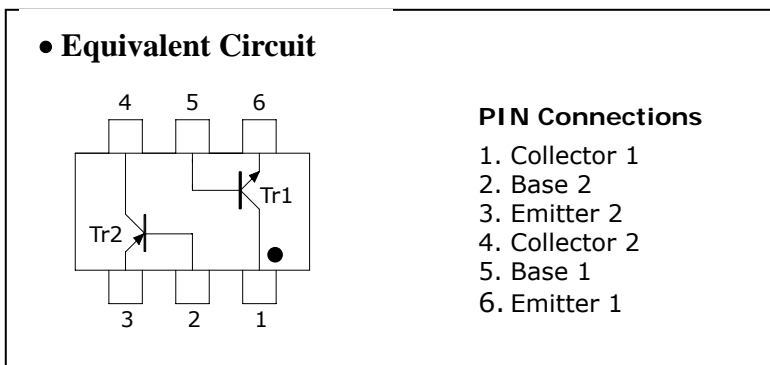

## Absolute Maximum Ratings [Tr1, Tr2]

( $T_a=25^\circ\text{C}$ )

Characteristic	Symbol	Rating		Unit
		Tr1	Tr2	
Collector-base voltage	$V_{CBO}$	60	-50	V
Collector-emitter voltage	$V_{CEO}$	50	-50	V
Emitter-base voltage	$V_{EBO}$	5	-5	V
Collector current	$I_C$	150	-150	mA
Collector power dissipation	$P_C^*$	300		mW
Junction temperature	$T_J$	150		$^\circ\text{C}$
Storage temperature range	$T_{stg}$	-55~150		$^\circ\text{C}$

※: Total rating(Each terminal mounted on a recommended solder land)

## Electrical Characteristics [Tr1]

(Ta=25°C)

Characteristic	Symbol	Test Condition	Min.	Typ.	Max.	Unit
Collector-emitter breakdown voltage	$BV_{CEO}$	$I_C=1mA, I_B=0$	50	-	-	V
Collector cut-off current	$I_{CBO}$	$V_{CB}=60V, I_E=0$	-	-	0.1	$\mu A$
Emitter cut-off current	$I_{EBO}$	$V_{EB}=5V, I_C=0$	-	-	0.1	$\mu A$
DC current gain	$h_{FE}$	$V_{CE}=6V, I_C=2mA$	120	-	400	-
Collector-emitter saturation voltage	$V_{CE(sat)}$	$I_C=100mA, I_B=10mA$	-	-	0.25	V
Base-emitter voltage	$V_{BE}$	$V_{CE}=6V, I_C=2mA$	-	0.65	-	V
Transition frequency	$f_T$	$V_{CE}=10V, I_C=10mA$	-	200	-	MHz
Collector output capacitance	$C_{ob}$	$V_{CB}=10V, I_E=0, f=1MHz$	-	2	-	pF

## Electrical Characteristics [Tr2]

(Ta=25°C)

Characteristic	Symbol	Test Condition	Min.	Typ.	Max.	Unit
Collector-emitter breakdown voltage	$BV_{CEO}$	$I_C=-1mA, I_B=0$	-50	-	-	V
Collector cut-off current	$I_{CBO}$	$V_{CB}=-50V, I_E=0$	-	-	-0.1	$\mu A$
Emitter cut-off current	$I_{EBO}$	$V_{EB}=-5V, I_C=0$	-	-	-0.1	$\mu A$
DC current gain	$h_{FE}$	$V_{CE}=-6V, I_C=-2mA$	120	-	400	-
Collector-emitter saturation voltage	$V_{CE(sat)}$	$I_C=-100mA, I_B=-10mA$	-	-	-0.3	V
Base-emitter voltage	$V_{BE}$	$V_{CE}=-6V, I_C=-2mA$	-	-0.65	-	V
Transition frequency	$f_T$	$V_{CE}=-10V, I_C=-10mA$	-	200	-	MHz
Collector output capacitance	$C_{ob}$	$V_{CB}=-10V, I_E=0, f=1MHz$	-	4	-	pF

Electrical Characteristic Curves

[Tr1]

Fig. 1  $I_C - V_{BE}$

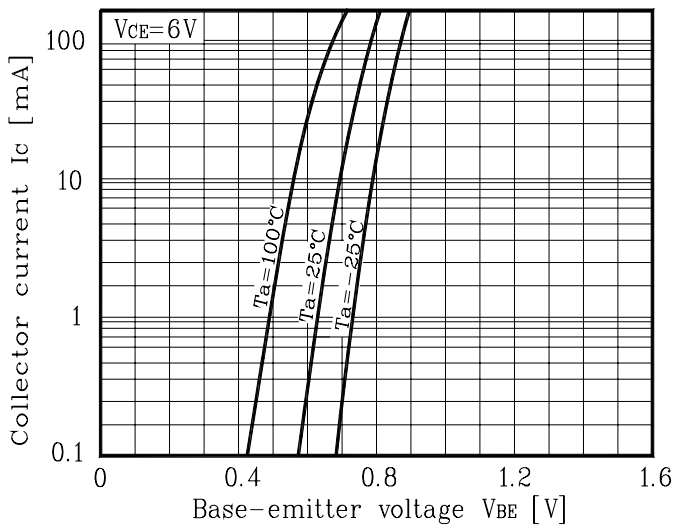
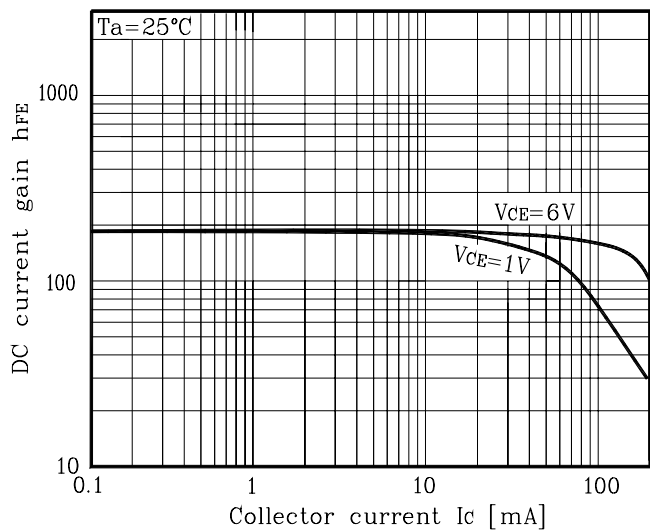

Fig. 3  $h_{FE} - I_C$



[Tr2]

Fig. 1  $I_C - V_{BE}$

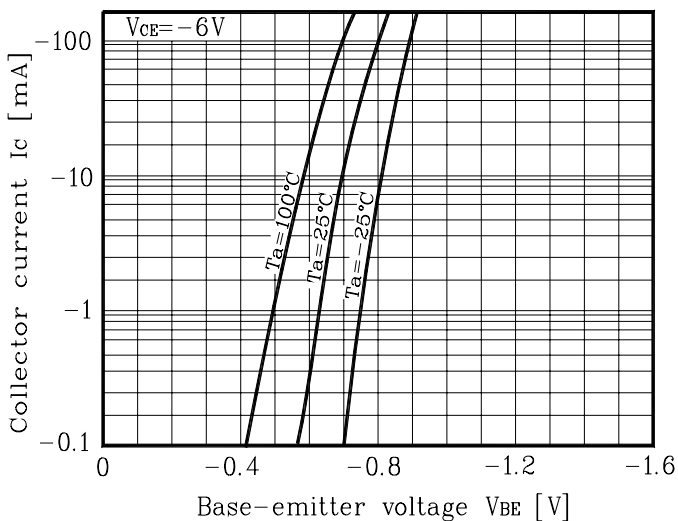

Fig. 2  $I_C - V_{CE}$

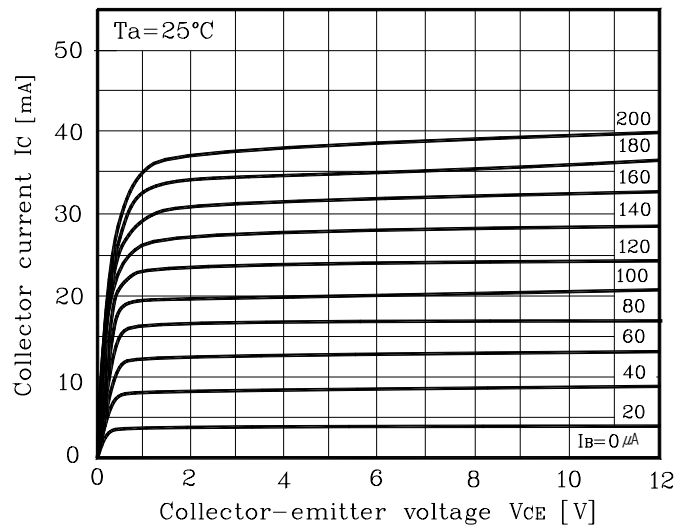

Fig. 4  $V_{CE(sat)} - I_C$

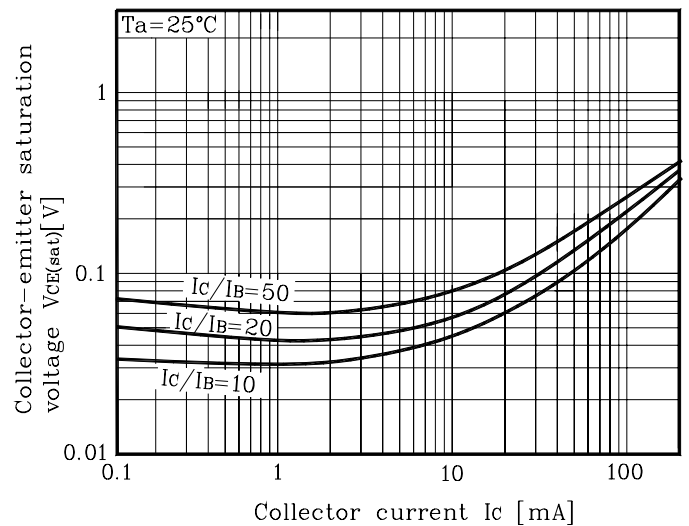
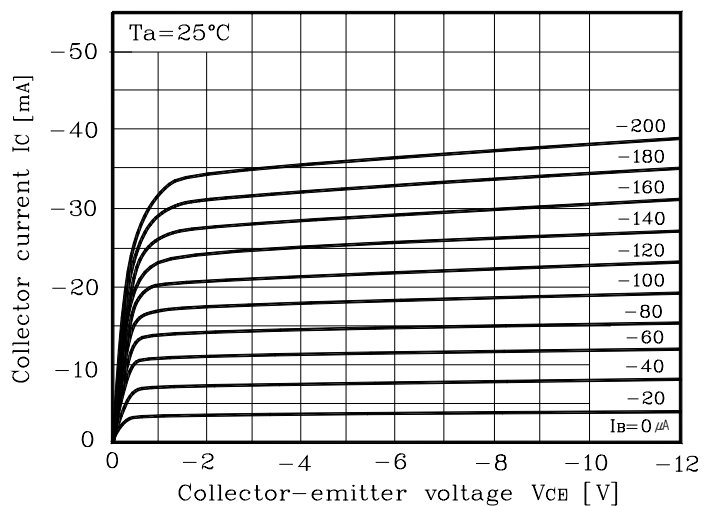

Fig. 2  $I_C - V_{CE}$



Electrical Characteristic Curves

Fig. 3  $h_{FE}-I_C$

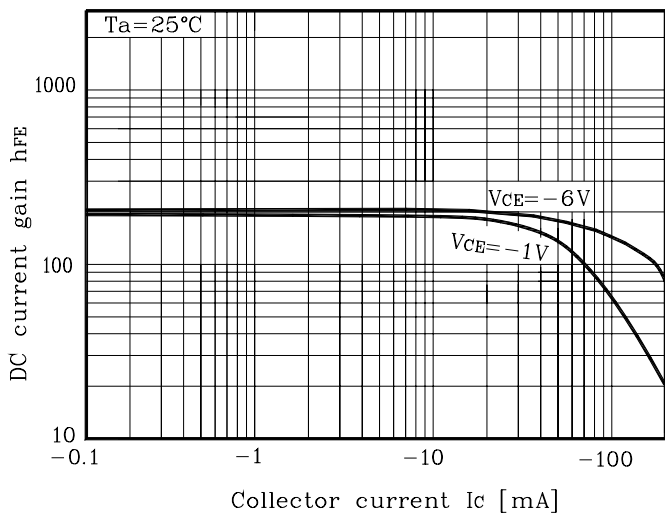
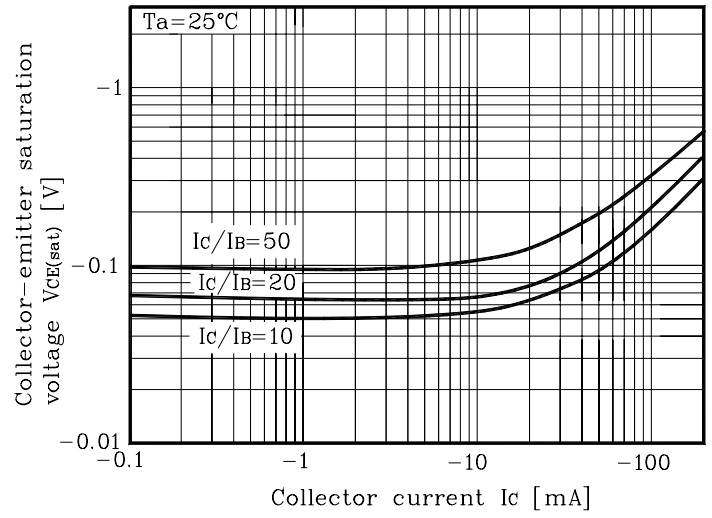
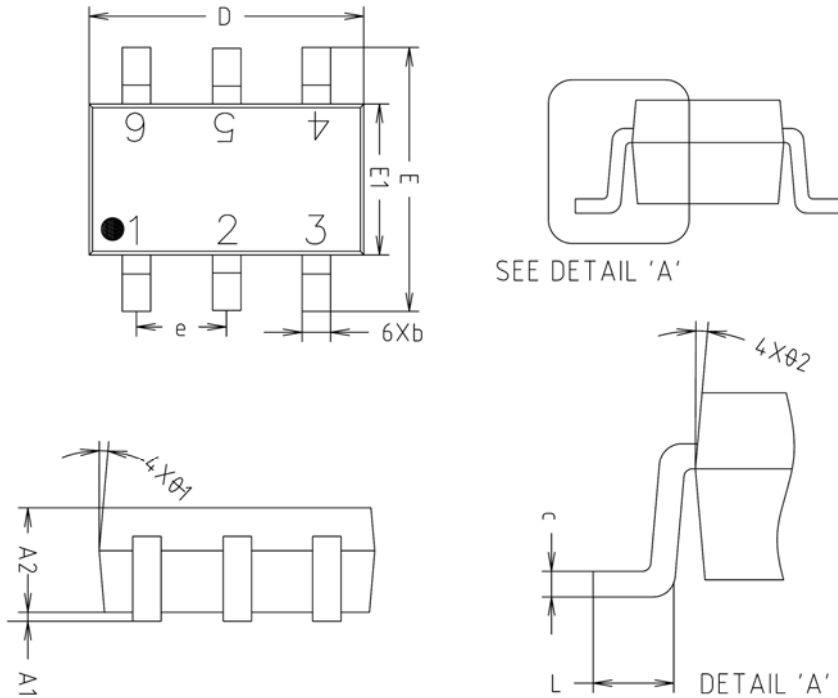

Fig. 4  $V_{CE(sat)}-I_C$



SOT-26 Outline Dimension(mm)



SYMBOL	MILLIMETERS(mm)			NOTE
	MINIMUM	NOMINAL	MAXIMUM	
A1	0.000	0.050	0.100	
A2	1.000	1.100	1.200	
b	-	0.400	0.450	
c	0.110	0.150	0.190	
D	2.800	2.900	3.000	
E	2.600	2.800	3.000	
E1	1.500	1.600	1.700	
e	0.930	0.950	0.970	
L	0.400	-	-	
θ1	5° REF			
θ2	5° REF			

※ Recommend PCB solder land [Unit: mm]

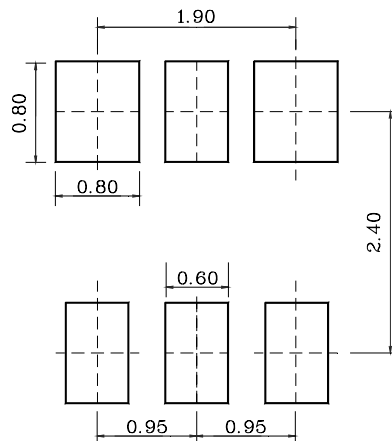

**The AUK Corp. products are intended for the use as components in general electronic equipment (Office and communication equipment, measuring equipment, home appliance, etc.).**

**Please make sure that you consult with us before you use these AUK Corp. products in equipments which require high quality and / or reliability, and in equipments which could have major impact to the welfare of human life(atomic energy control, airplane, spaceship, transportation, combustion control, all types of safety device, etc.). AUK Corp. cannot accept liability to any damage which may occur in case these AUK Corp. products were used in the mentioned equipments without prior consultation with AUK Corp..**

**Specifications mentioned in this publication are subject to change without notice.**