

Descriptions

- General purpose amplifier
- Recommended for LED Drive Application

Features

- Thermally Enhanced Power PKG
- Low saturation: $V_{CE(sat)} = 0.5V$ Max
- 2 NPN chips in TESOP-8 Package

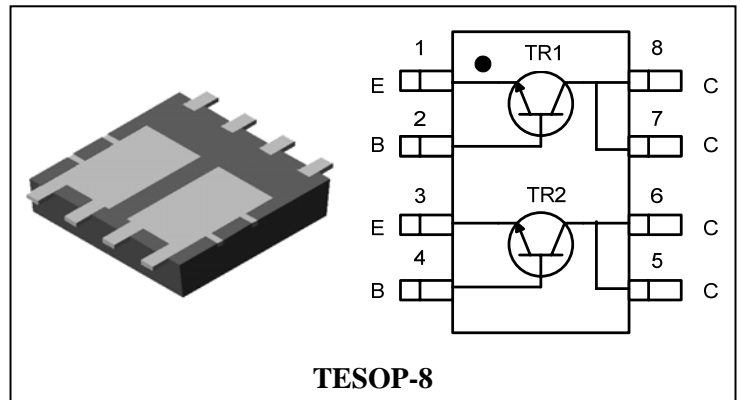

Ordering Information

Type NO.	Marking	Package Code
SUT161G	SUT161□	TESOP-8

□ : Year & Week Code

Absolute maximum ratings(TR1, TR2)

($T_a = 25^\circ C$)

Characteristic	Symbol	Ratings	Unit
Collector-Base voltage	V_{CBO}	160	V
Collector-Emitter voltage	V_{CEO}	160	V
Emitter-Base voltage	V_{EBO}	6	V
Collector current	I_C	1	A(DC)
	I_{CP}^*	2	A(Pulse)
Collector power dissipation	$P_C(T_a = 25^\circ C)^{**}$	0.75	W/TOTAL
		0.55	W/ELEMENT
	$P_C(T_c = 25^\circ C)$	7.5	W/TOTAL
Junction temperature	T_j	150	$^\circ C$
Storage temperature	T_{stg}	-55~150	$^\circ C$

* : Single pulse, $t_p = 300 \mu s$

** : Each terminal mounted on a recommended solder land

Electrical Characteristics(TR1, TR2)

Characteristic	Symbol	Test Condition	Min.	Typ.	Max.	Unit
Collector-Base breakdown voltage	BV_{CBO}	$I_C = 100 \mu A, I_E = 0$	160	-	-	V
Collector-Emitter breakdown voltage	BV_{CEO}	$I_C = 1 mA, I_B = 0$	160	-	-	V
Emitter-Base breakdown voltage	BV_{EBO}	$I_E = 100 \mu A, I_C = 0$	6	-	-	V
Collector cut-off current	I_{CBO}	$V_{CB} = 160V, I_E = 0$	-	-	0.1	μA
Emitter cut-off current	I_{EBO}	$V_{EB} = 4V, I_C = 0$	-	-	0.1	μA
DC current gain	$h_{FE}^{1)}$	$V_{CE} = 5V, I_C = 30 mA$	200	-	400	-
Collector-Emitter saturation voltage	$V_{CE(sat)}$	$I_C = 500 mA, I_B = 50 mA$	-	-	0.5	V
Base-Emitter saturation voltage	$V_{BE(sat)}$	$I_C = 500 mA, I_B = 50 mA$	-	-	1.2	V
Transition frequency	f_T	$V_{CE} = 5V, I_C = 50 mA$	-	150	-	MHz
Collector output capacitance	C_{ob}	$V_{CB} = 10V, I_E = 0, f = 1 MHz$	-	10	-	pF

Note 1) h_{FE} Rank : 200~400 only

Electrical Characteristic Curves(TR1, TR2)

Fig. 1 $P_C - T_a$

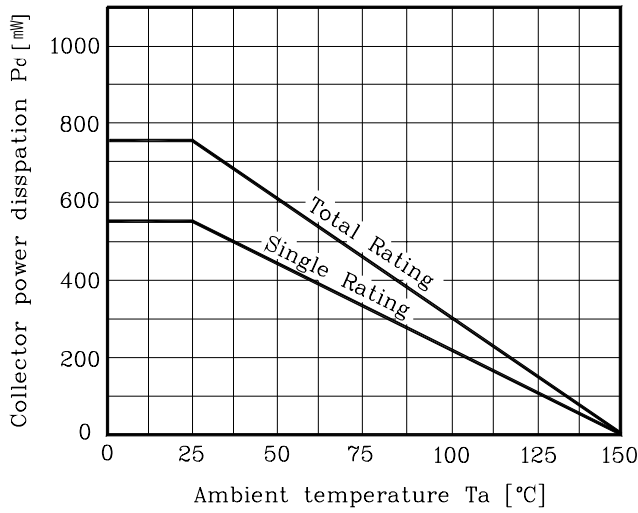

Fig. 2 $I_C - V_{BE}$

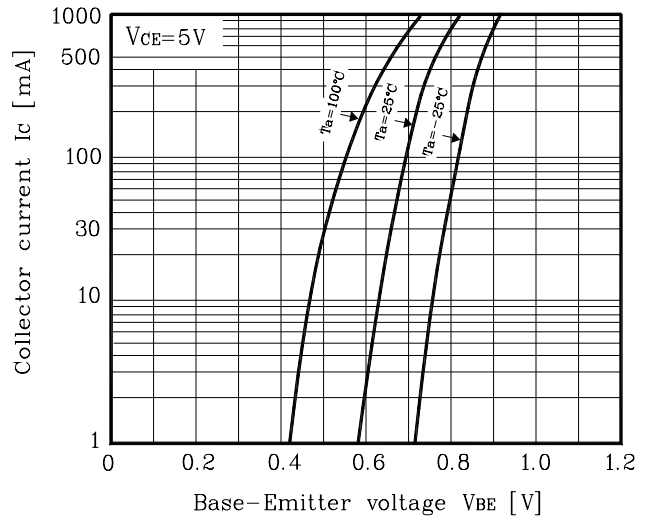

Fig. 3 $V_{CE(sat)} - I_C$

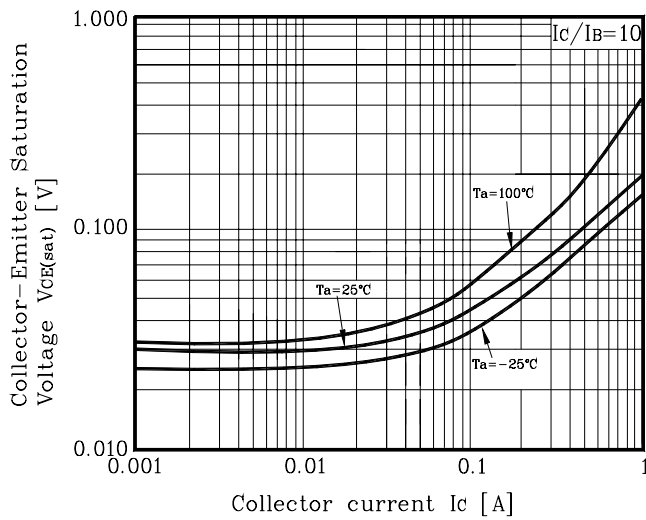

Fig. 4 $I_C - V_{CE}$

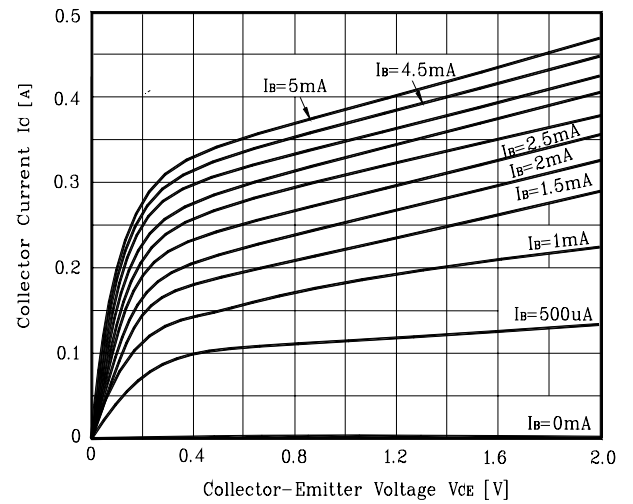

Fig. 5 $I_C - V_{CE}$

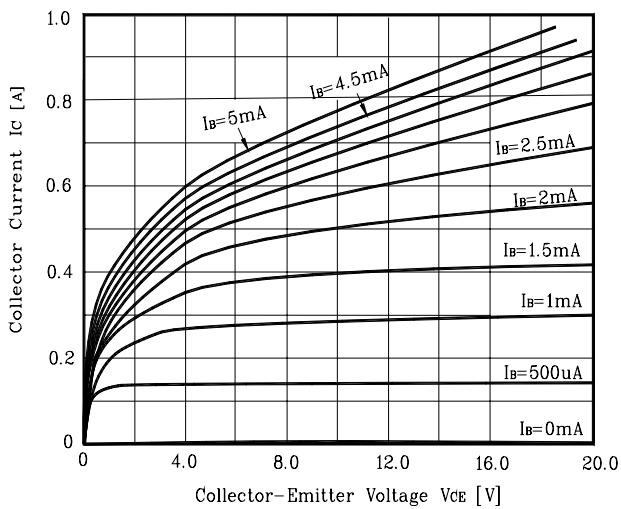
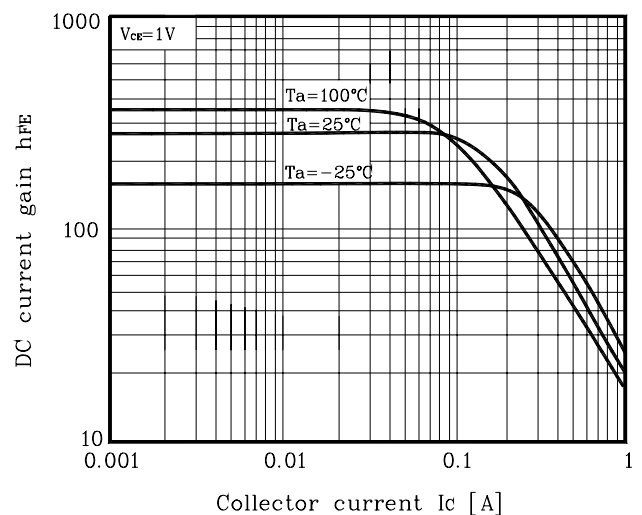

Fig. 6 $h_{FE} - I_C$



Electrical Characteristic Curves

Fig. 7 $h_{FE}-I_C$

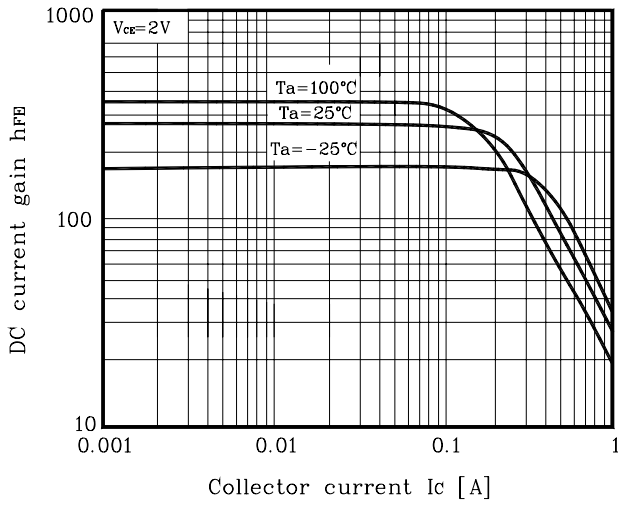

Fig. 8 $h_{FE}-I_C$

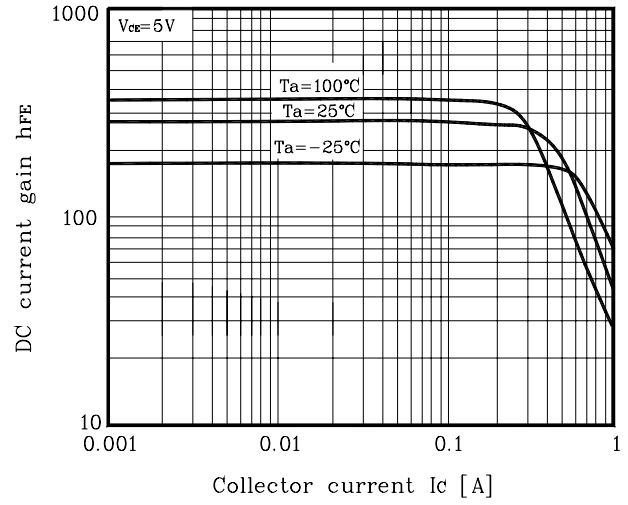

Fig. 9 $h_{FE}-I_C$

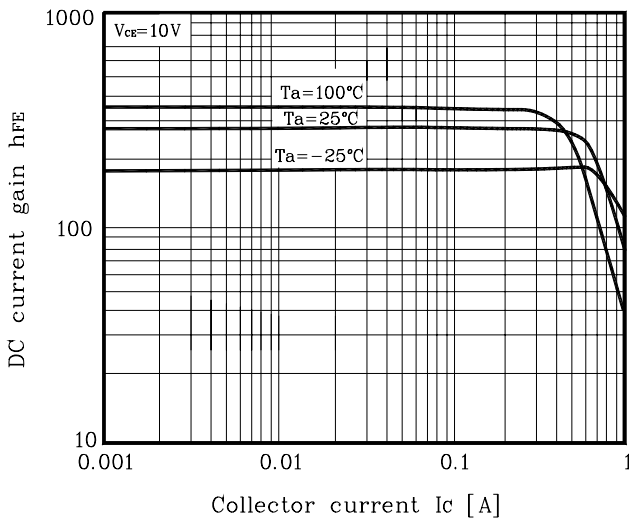

Fig. 10 $C_{ob} - V_{CB}$

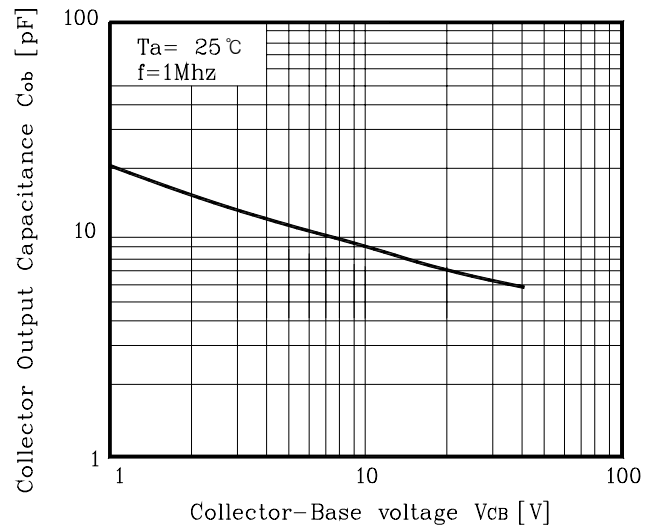

Fig. 11 $f_T - I_C$

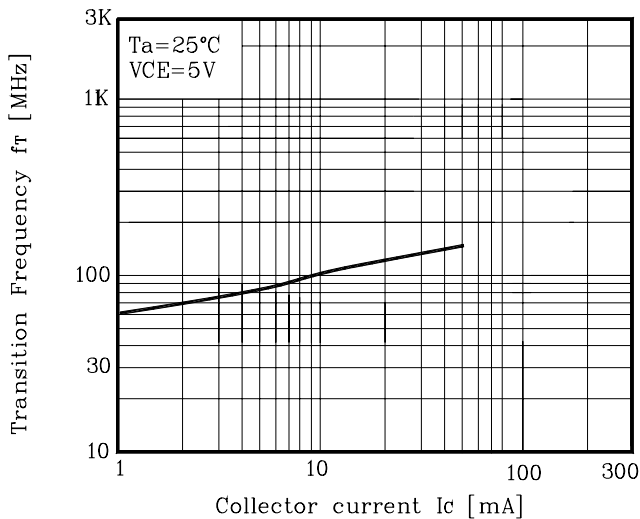
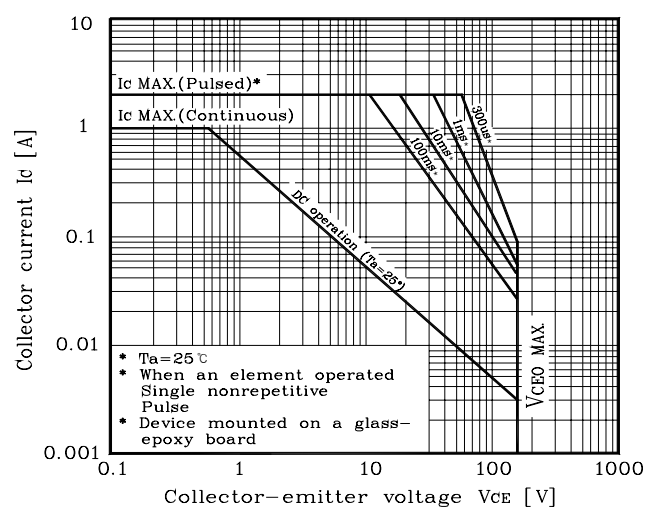
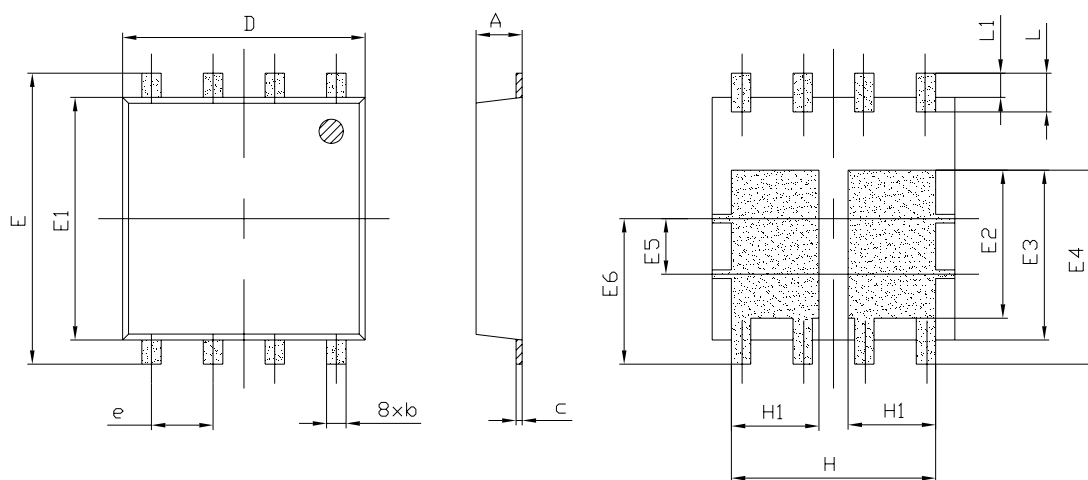

Fig. 12 Safe operating Area



Outline Dimension



SYMBOL	MILLIMETER(mm)			NOTE
	MINIMUM	NOMINAL	MAXIMUM	
A	0.900	0.950	1.000	
b	0.350	0.400	0.500	
c	0.077	0.127	0.157	
D	4.900	5.000	5.100	
E	5.850	6.000	6.150	
E1	4.900	5.000	5.100	
E2	2.850	3.050	3.250	
E3	3.300	3.500	3.700	
E4	3.800	4.000	4.200	
E5	1.145 TYP			
E6	3.000 TYP			
e	1.270 TYP			
H	4.210 TYP			
H1	1.805 TYP			
L	0.650	0.800	0.950	
L1	0.350	0.500	0.650	

※Recommend PCB solder land [Unit: mm]

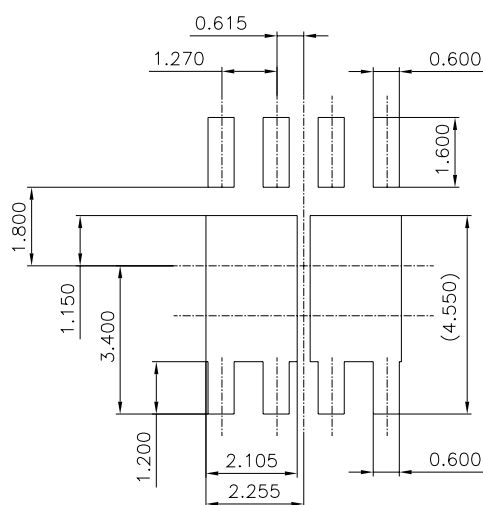

The AUK Corp. products are intended for the use as components in general electronic equipment (Office and communication equipment, measuring equipment, home appliance, etc.).

Please make sure that you consult with us before you use these AUK Corp. products in equipments which require high quality and / or reliability, and in equipments which could have major impact to the welfare of human life(atomic energy control, airplane, spaceship, transportation, combustion control, all types of safety device, etc.). AUK Corp. cannot accept liability to any damage which may occur in case these AUK Corp. products were used in the mentioned equipments without prior consultation with AUK Corp..

Specifications mentioned in this publication are subject to change without notice.