

Descriptions

- General purpose amplifier
- Recommended for LED Drive Application

Features

- Reduce quantity of parts and mounting cost
- Low saturation: $V_{CE(sat)} = 0.5V$ Max
- 2 NPN chips in SOT-26 Package

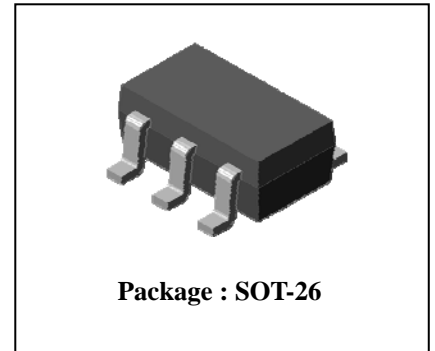

Ordering Information

Type NO.	Marking	Package Code
SUT041N	41□	SOT-26

□ : Year & Week Code

PIN Assignment & Description

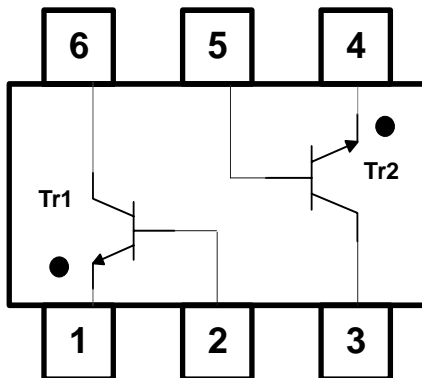

[Pin Assignment]

Pin	Description
1	Emitter 1
2	Base 1
3	Collector 2
4	Emitter 2
5	Base 2
6	Collector 1

Absolute maximum ratings(TR1, TR2)

(Ta=25°C)

Characteristic	Symbol	Ratings	Unit
Collector-Base voltage	V_{CBO}	45	V
Collector-Emitter voltage	V_{CEO}	40	V
Emitter-Base voltage	V_{EBO}	5	V
Collector current	I_C	1	A(DC)
	I_{CP}^*	2	A(Pulse)
Collector power dissipation	P_C^{**}	0.5	W
Junction temperature	T_J	150	°C
Storage temperature	T_{stg}	-55~150	°C

* : Single pulse, $t_p = 300 \mu s$

** : Total rating(Each terminal mounted on a recommended solder land)

Electrical Characteristics(TR1, TR2)

Characteristic	Symbol	Test Condition	Min.	Typ.	Max.	Unit
Collector-Base breakdown voltage	BV_{CBO}	$I_C = 100 \mu A, I_E = 0$	45	-	-	V
Collector-Emitter breakdown voltage	BV_{CEO}	$I_C = 1 mA, I_B = 0$	40	-	-	V
Emitter-Base breakdown voltage	BV_{EBO}	$I_E = 10 \mu A, I_C = 0$	5	-	-	V
Collector cut-off current	I_{CBO}	$V_{CB} = 45V, I_E = 0$	-	-	0.1	μA
Emitter cut-off current	I_{EBO}	$V_{EB} = 5V, I_C = 0$	-	-	0.1	μA
DC current gain	h_{FE}^*	$V_{CE} = 1V, I_C = 100mA$	160	-	320	-
Collector-Emitter saturation voltage	$V_{CE(sat)}^*$	$I_C = 500mA, I_B = 50mA$	-	-	0.5	V
Transition frequency	f_T	$V_{CE} = 5V, I_C = 10mA$	-	150	-	MHz
Collector output capacitance	C_{ob}	$V_{CB} = 10V, I_E = 0, f = 1MHz$	-	8	-	pF

* Note 1) h_{FE} Rank : 160~320 only

* Note 2) Pulse Tester : Pulse Width $\leq 300 \mu s$, Duty Cycle $\leq 2.0\%$

Electrical Characteristic Curves(TR1, TR2)

Fig. 1 $P_C - T_a$

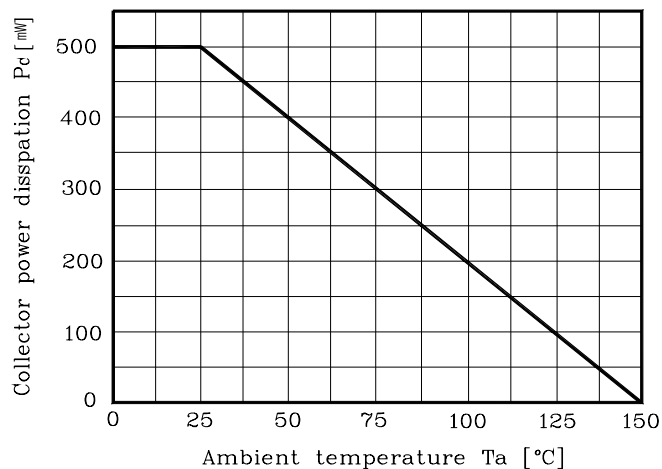

Fig. 2 $I_C - V_{BE}$

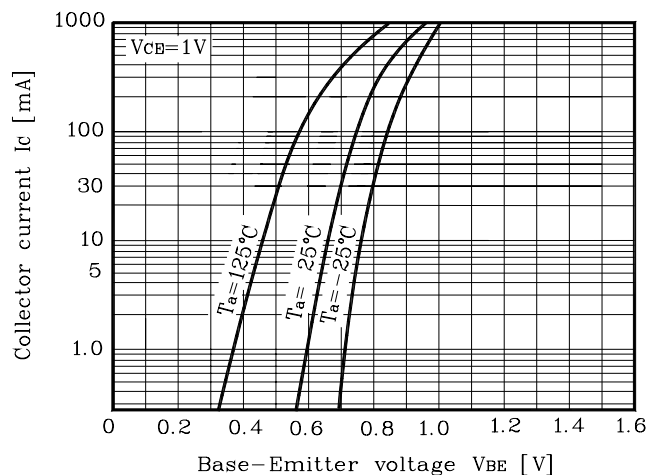

Fig. 3 $V_{CE(sat)} - I_C$

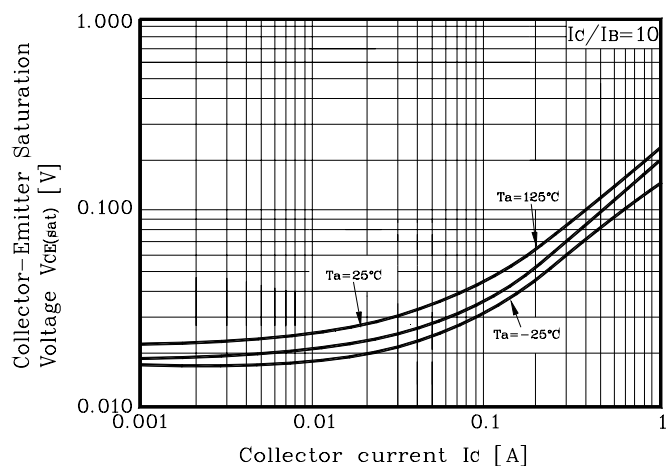

Fig. 4 $I_C - V_{CE}$

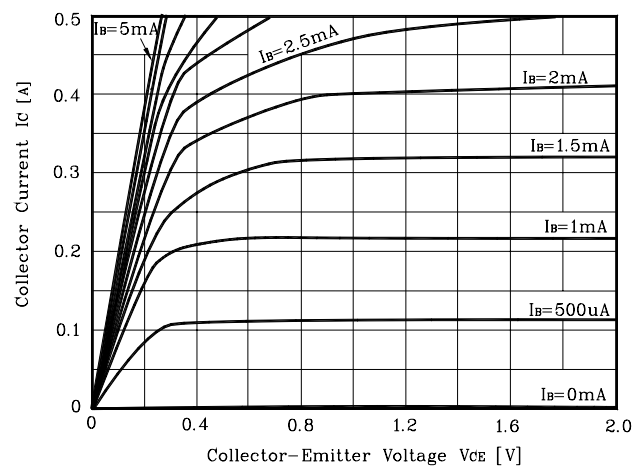

Fig. 5 $I_C - V_{CE}$

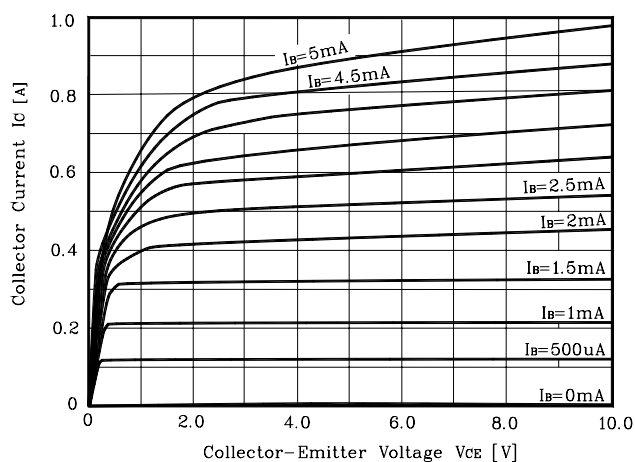

Fig. 6 $h_{FE} - I_C$

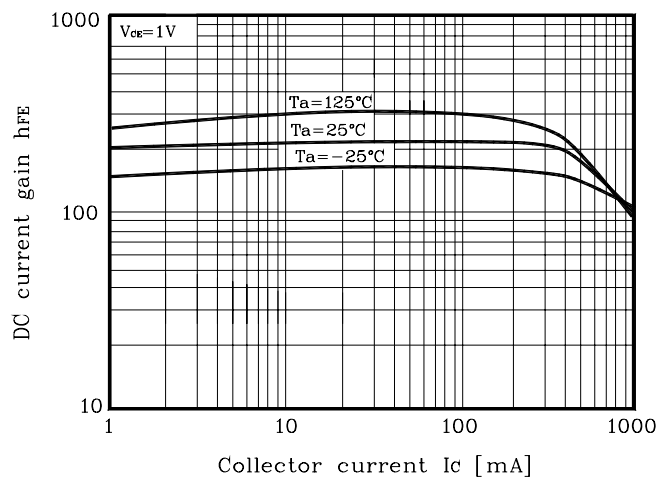

Fig. 7 $h_{FE} - I_C$

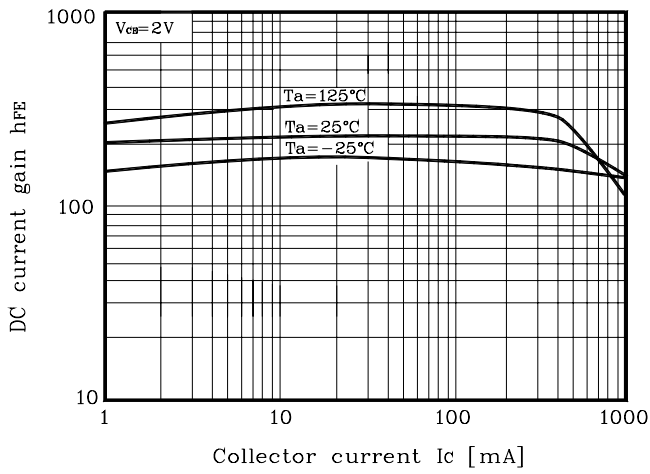

Fig. 8 $h_{FE} - I_C$

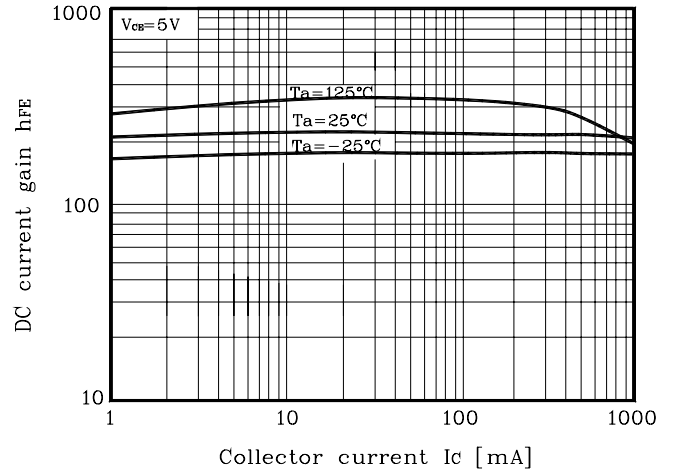

Fig. 9 $C_{ob} - V_{CB}$

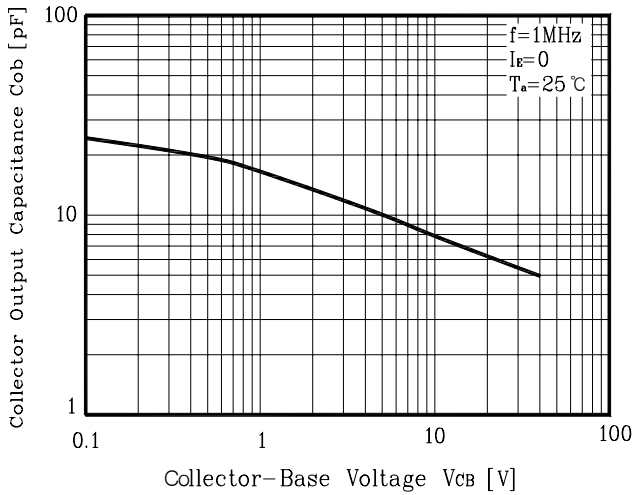
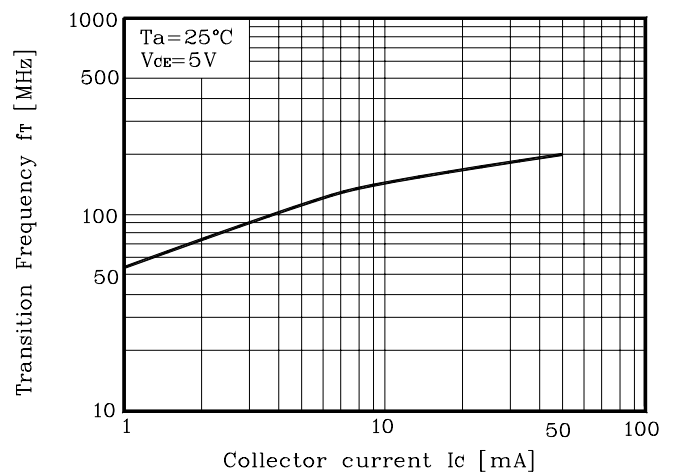
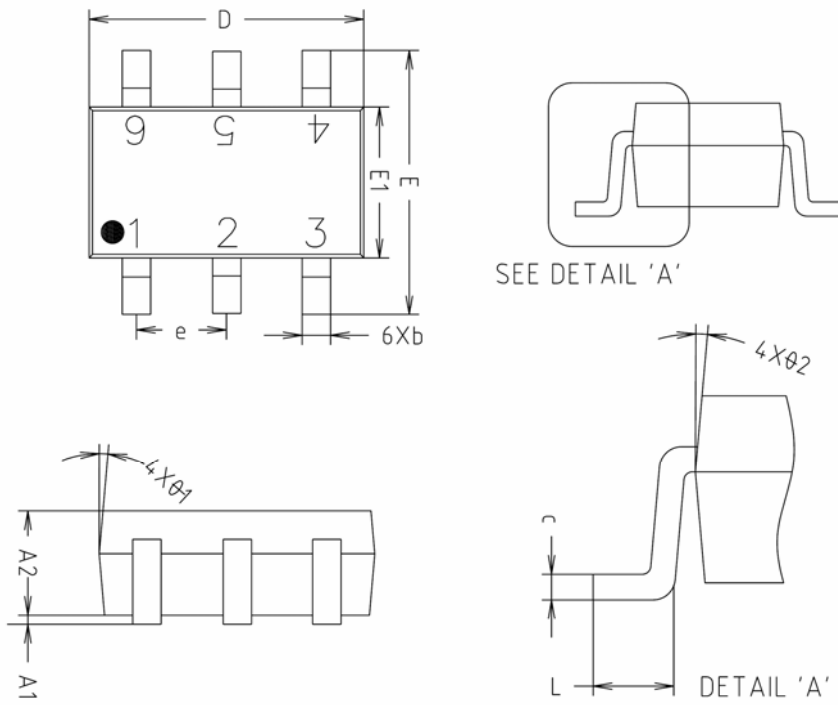

Fig. 10 $f_T - I_C$



SOT-26 Outline Dimension(mm)



SYMBOL	MILLIMETERS(mm)			NOTE
	MINIMUM	NOMINAL	MAXIMUM	
A1	0.000	0.050	0.100	
A2	1.000	1.100	1.200	
b	-	0.400	0.450	
c	0.110	0.150	0.190	
D	2.800	2.900	3.000	
E	2.600	2.800	3.000	
E1	1.500	1.600	1.700	
e	0.930	0.950	0.970	
L	0.400	-	-	
Ø1	5° REF			
Ø2	5° REF			

※ Recommend PCB solder land [Unit: mm]

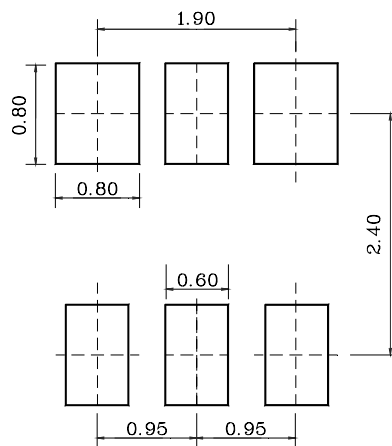

The AUK Corp. products are intended for the use as components in general electronic equipment (Office and communication equipment, measuring equipment, home appliance, etc.).

Please make sure that you consult with us before you use these AUK Corp. products in equipments which require high quality and / or reliability, and in equipments which could have major impact to the welfare of human life(atomic energy control, airplane, spaceship, transportation, combustion control, all types of safety device, etc.). AUK Corp. cannot accept liability to any damage which may occur in case these AUK Corp. products were used in the mentioned equipments without prior consultation with AUK Corp..

Specifications mentioned in this publication are subject to change without notice.