

**Descriptions**

- General purpose application
- Switching application

**Features**

- Large collector current
- Low collector saturation voltage
- Complementary pair with STN2222

**Ordering Information**

Type NO.	Marking	Package Code
STN2907	STN2907	TO-92

**Outline Dimensions**

unit : mm

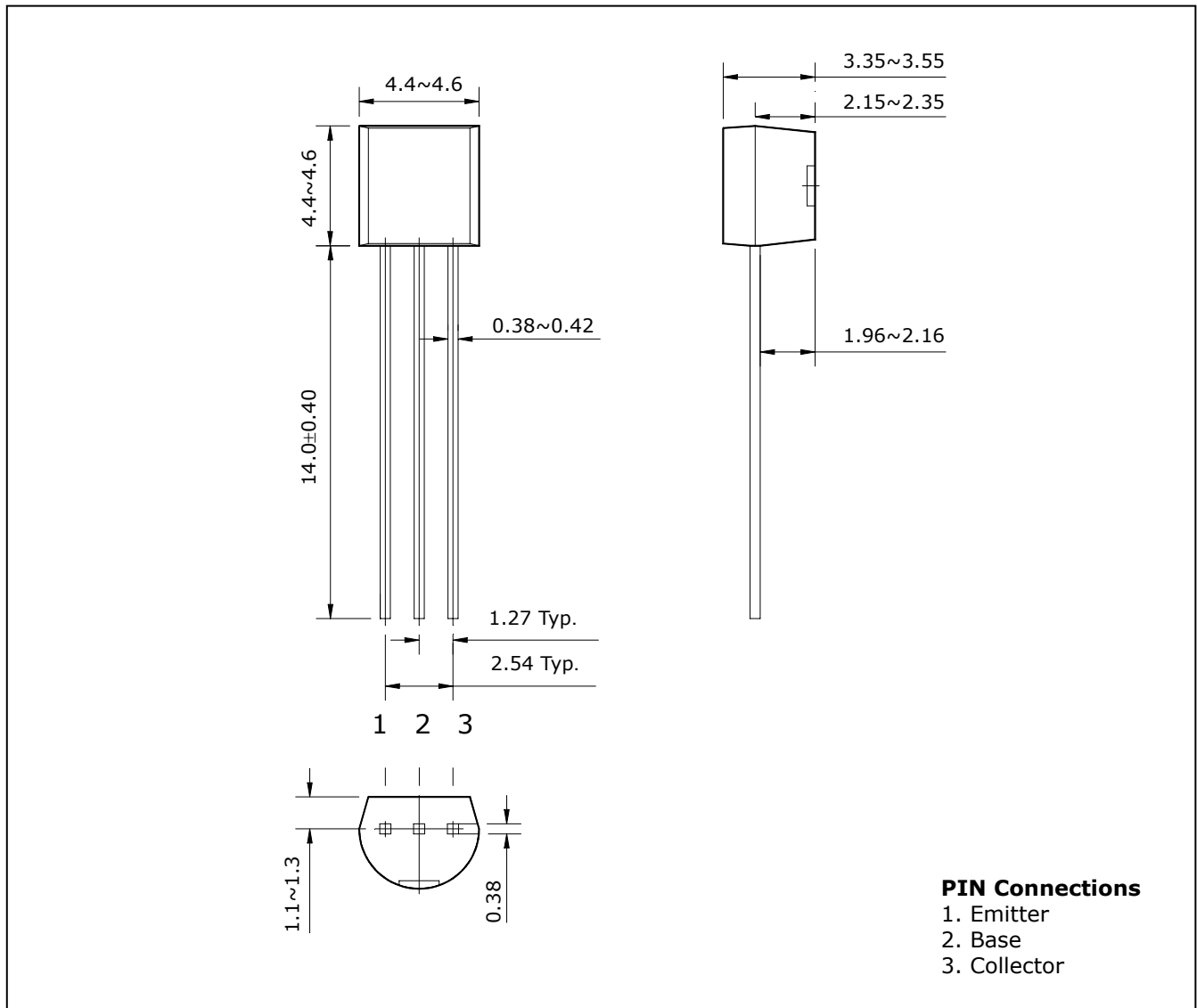

**Absolute maximum ratings**

Ta=25°C

Characteristic	Symbol	Ratings	Unit
Collector-Base voltage	$V_{CBO}$	-60	V
Collector-Emitter voltage	$V_{CEO}$	-40	V
Emitter-Base voltage	$V_{EBO}$	-5	V
Collector current	$I_C$	-600	mA
Collector dissipation	$P_C$	625	mW
Junction temperature	$T_j$	150	°C
Storage temperature	$T_{stg}$	-55~150	°C

**Electrical Characteristics**

Ta=25°C

Characteristic	Symbol	Test Condition	Min.	Typ.	Max.	Unit
Collector-Base breakdown voltage	$BV_{CBO}$	$I_C = -10\mu A, I_E = 0$	-60	-	-	V
Collector-Emitter breakdown voltage	$BV_{CEO}$	$I_C = -1mA, I_B = 0$	-40	-	-	V
Emitter-Base breakdown voltage	$BV_{EBO}$	$I_E = -10\mu A, I_C = 0$	-5	-	-	V
Collector cut-off current	$I_{CBO}$	$V_{CB} = -50V, I_E = 0$	-	-	-10	nA
DC current gain	$h_{FE}$	$V_{CE} = -10V, I_C = -10mA$	75	-	-	-
Collector-Emitter saturation voltage	$V_{CE(sat)}$	$I_C = -150mA, I_B = -15mA$	-	-	-0.4	V
Transistor frequency	$f_T$	$V_{CE} = -20V, I_C = -50mA$	250	-	-	MHz
Collector output capacitance	$C_{ob}$	$V_{CB} = -10V, I_E = 0, f = 1MHz$	-	6.0	-	pF

Electrical Characteristic Curves

Fig. 1  $P_C-T_a$

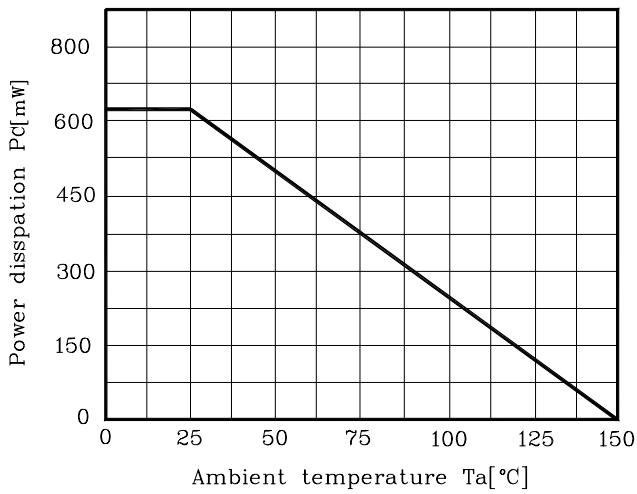

Fig. 2  $I_C-V_{BE}$

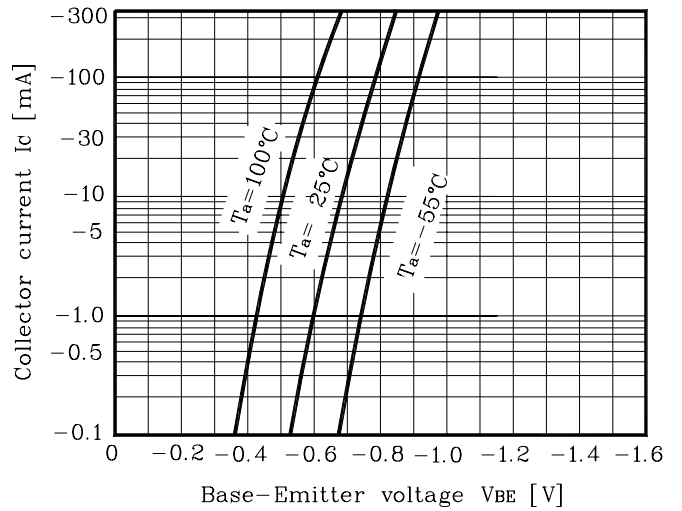

Fig. 3  $I_C-V_{CE}$

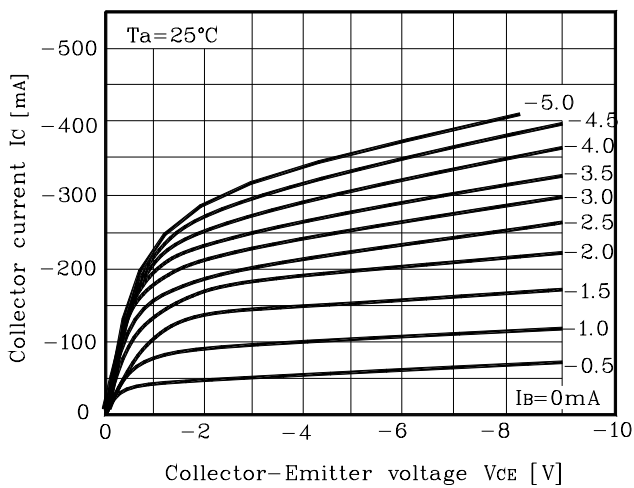

Fig. 4  $V_{CE(sat)}-I_C$

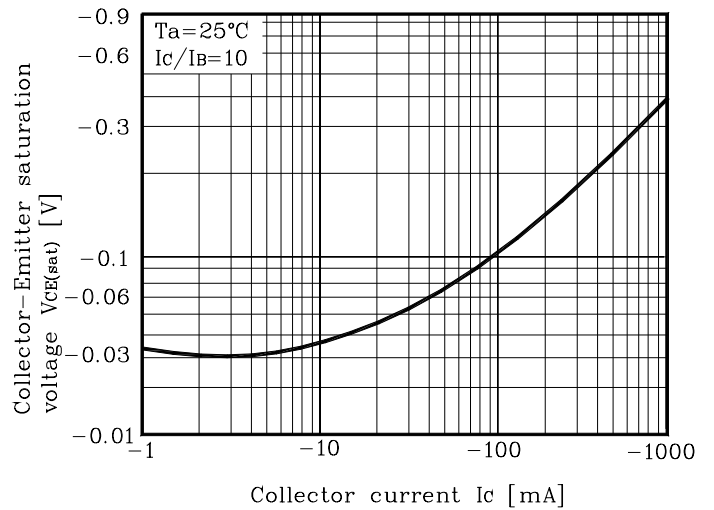

Fig. 5  $h_{FE}-I_C$

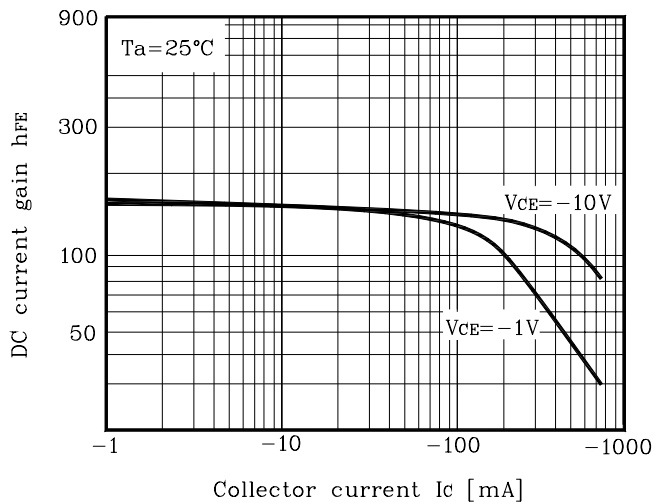
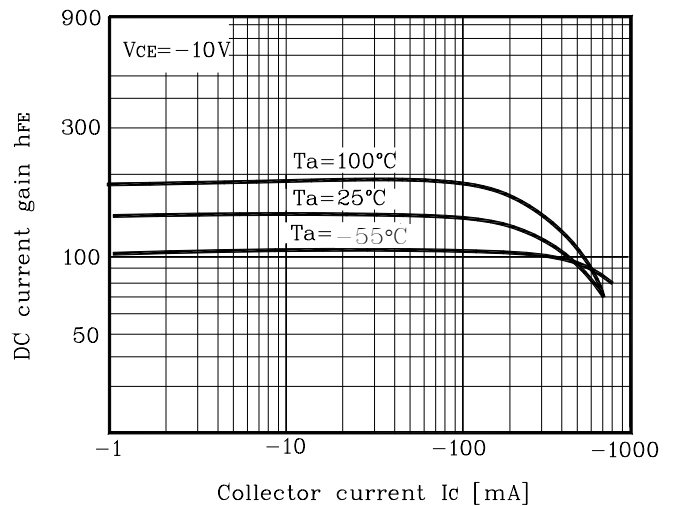

Fig. 6  $h_{FE}-I_C$



**These AUK products are intended for usage in general electronic equipments(Office and communication equipment, measuring equipment, domestic electrification, etc.).**

**Please make sure that you consult with us before you use these AUK products in equipments which require high quality and/or reliability, and in equipments which could have major impact to the welfare of human life(atomic energy control, airplane, spaceship, traffic signal, combustion central, all types of safety device, etc.).**

**AUK cannot accept liability to any damage which may occur in case these AUK products were used in the mentioned equipments without prior consultation with AUK.**