

## SWITCHING REGULATOR APPLICATIONS

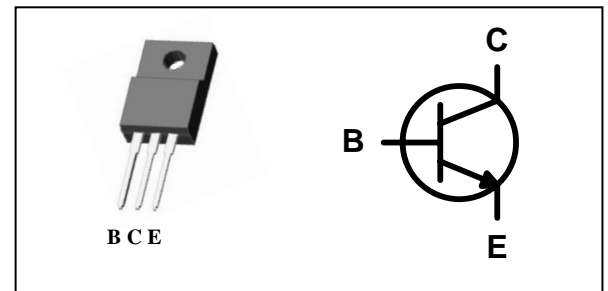
### Features

- High speed switching
- High Collector Voltage :  $V_{CBO} = 700V$
- Suitable for Switching Regulator and Motor Control

### Ordering Information

Type NO.	Marking	Package Code
STD13007F	STD13007	TO-220F-3L

### PIN Connection



### Absolute maximum ratings

(Ta=25°C)

Characteristic	Symbol	Rating	Unit
Collector-Base voltage	$V_{CBO}$	700	V
Collector-Emitter voltage	$V_{CEO}$	400	V
Emitter-base voltage	$V_{EBO}$	9	V
Collector current (DC)	$I_C$	8	A
Collector current (Pulse)	$I_{CM}$	16	A
Base current (DC)	$I_B$	4	A
Collector Power dissipation (Tc=25°C)	$P_C$	40	W
Junction temperature	$T_j$	150	°C
Storage temperature	$T_{stg}$	-55 ~ 150	°C

Characteristic		Symbol	Typ.	Max	Unit
Thermal resistance	Junction-case	$R_{th(J-C)}$	-	3.12	°C/W
	Junction-ambient	$R_{th(J-a)}$	-	62.5	

## Electrical Characteristics

(Ta=25°C)

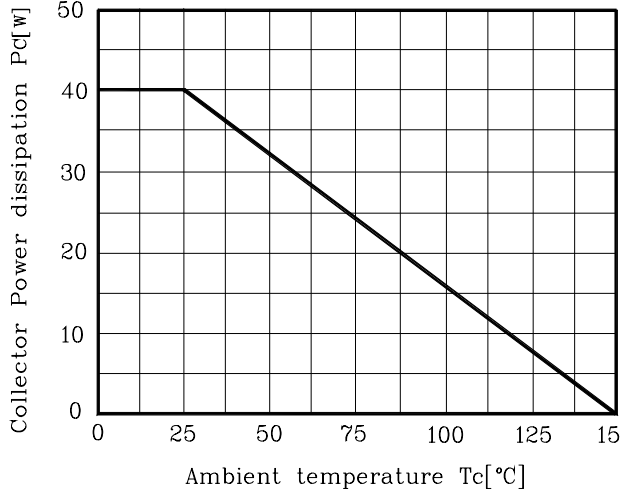
Characteristic	Symbol	Test Condition	Min.	Typ.	Max.	Unit
Collector-Emitter sustaining voltage	$BV_{CEO(sus)}$	$I_C=10mA, I_B=0$	400	-	-	V
Emitter cut-off current	$I_{EBO}$	$V_{EB}=9V, I_C=0$	-	-	1	mA
DC Current gain	$h_{FE}^*$	$I_C=2A, V_{CE}=5V^*$	10	-	45	
		$I_C=5A, V_{CE}=5V$	5	-	30	
Collector-Emitter saturation voltage	$V_{CE(sat)}^*$	$I_C=2A, I_B=0.4A$	-	-	1	V
		$I_C=5A, I_B=1A$	-	-	2	
		$I_C=8A, I_B=2A$	-	-	3	
Base-Emitter saturation voltage	$V_{BE(sat)}^*$	$I_C=2A, I_B=0.4A$	-	-	1.2	V
		$I_C=5A, I_B=1A$	-	-	1.6	
Transition frequency	$f_T$	$V_{CE}=10V, I_C=0.5A, f=1MHz$	-	14	-	MHz
Output capacitance	$C_{ob}$	$V_{CB}=10V, I_E=0, f=0.1MHz$	-	80	-	pF
Turn on Time	$t_{on}$	$V_{CC}=125V, I_C=5A$ $I_{B1}=-I_{B2}=1A$	-	1.6	-	$\mu s$
Storage Time	$t_{stg}$		-	3	-	
Fall Time	$t_f$		-	0.7	-	

\* Pulse test:  $PW \leq 300 \mu s$ , Duty cycle  $\leq 2\%$ .

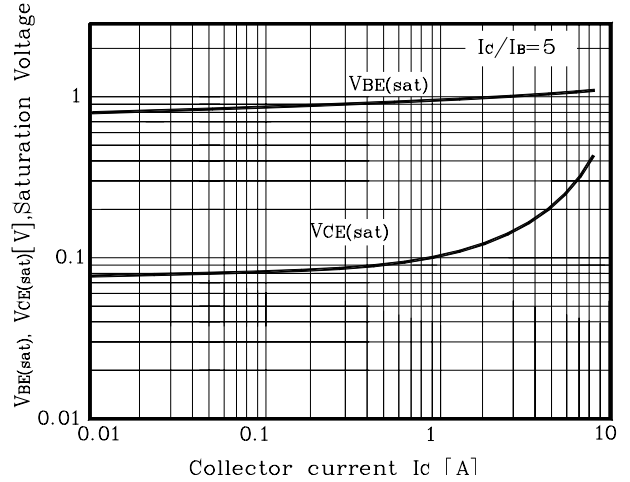
\*  $h_{FE}$  rank / A : 10~30, B : 25~45

## Electrical Characteristic Curves

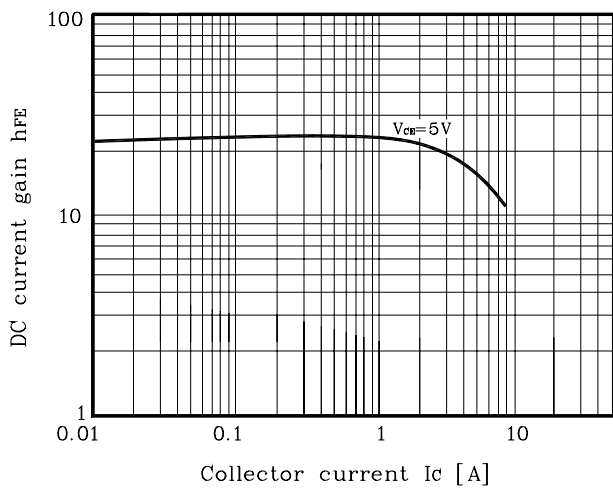
**Fig. 1  $P_C - T_C$**



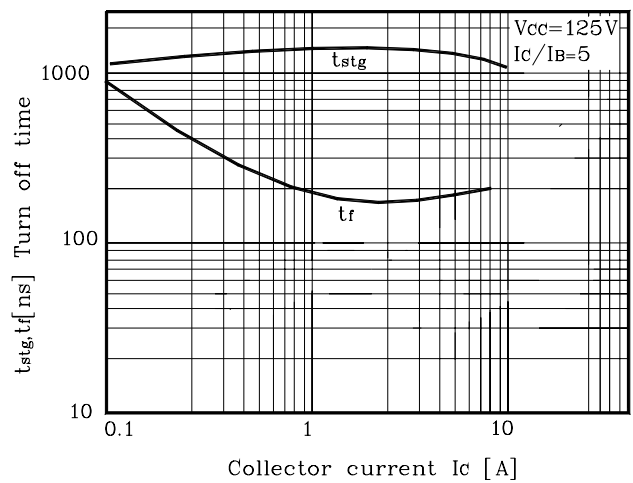
**Fig. 2  $V_{BE(sat)}, V_{CE(sat)} - I_C$**



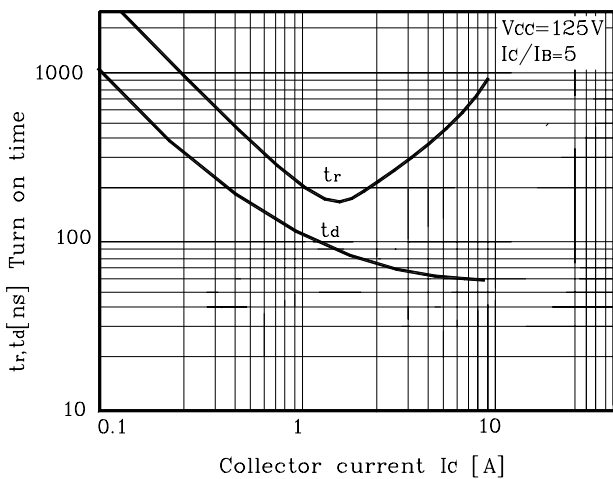
**Fig. 3  $h_{FE} - I_C$**



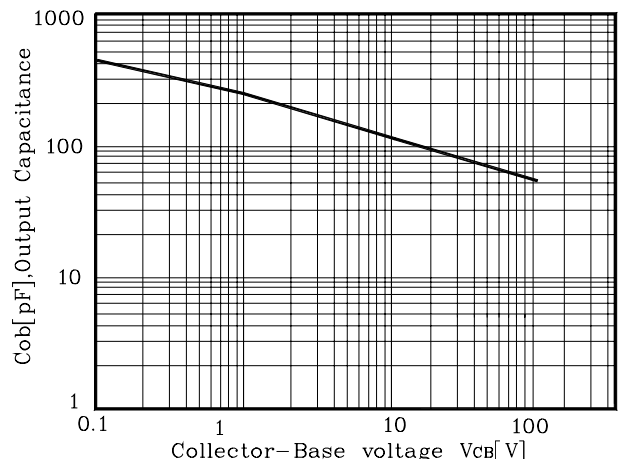
**Fig. 4  $t_r, t_{stg} - I_C$**



**Fig. 5  $t_d, t_r - I_C$**

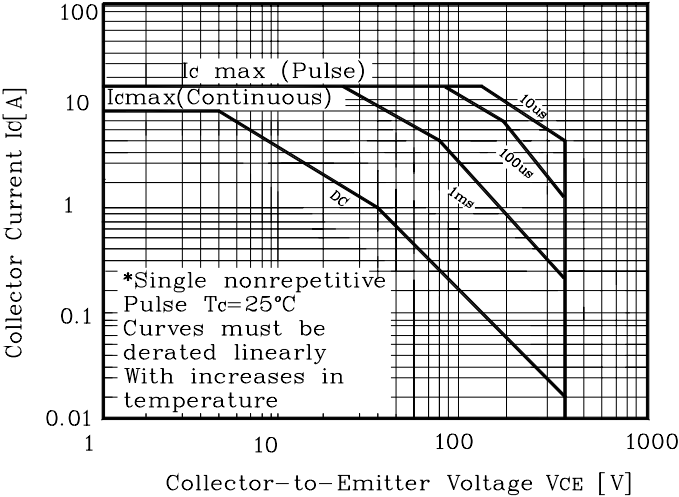


**Fig. 6  $C_{ob} - V_{CB}$**

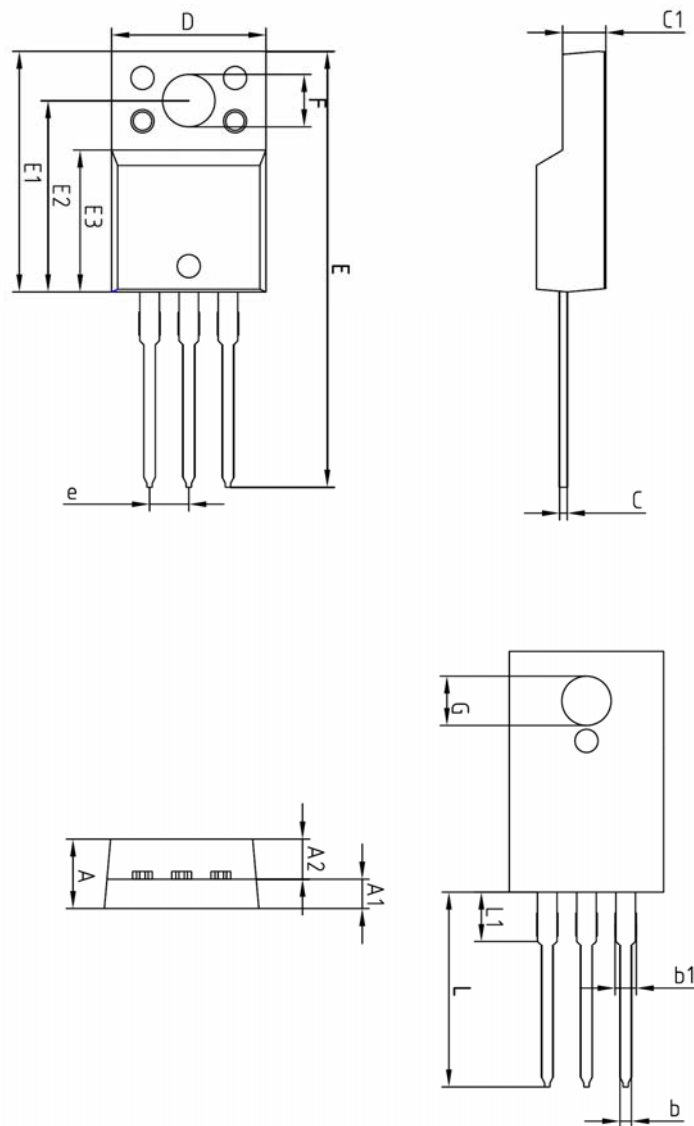


# Electrical Characteristic Curves

Fig. 7 Safe Operating Area



## Outline Dimension



SYMBOL	MILLIMETERS			NOTE
	MINIMUM	NOMINAL	MAXIMUM	
A	-	-	4.60	
A1	2.45	2.50	2.55	
A2	1.95	2.00	2.05	
b	0.65	0.75	0.85	
b1	1.07	1.27	1.47	
C	0.40	0.50	0.60	
C1	2.70	2.80	2.90	
D	9.90	10.00	10.10	
E	28.00	-	28.60	
E1	15.50	15.60	15.70	
E2	12.30	12.40	12.50	
E3	9.15	9.20	9.25	
F	3.30	3.40	3.50	
G	3.10	3.20	3.30	
e		2.54 BSC		
L	12.40	-	13.00	
L1		3.46 BSC		

**The AUK Corp. products are intended for the use as components in general electronic equipment (Office and communication equipment, measuring equipment, home appliance, etc.).**

**Please make sure that you consult with us before you use these AUK Corp. products in equipments which require high quality and / or reliability, and in equipments which could have major impact to the welfare of human life(atomic energy control, airplane, spaceship, transportation, combustion control, all types of safety device, etc.). AUK Corp. cannot accept liability to any damage which may occur in case these AUK Corp. products were used in the mentioned equipments without prior consultation with AUK Corp..**

**Specifications mentioned in this publication are subject to change without notice.**