

## General Purpose Schottky Barrier Diode

### General Description

These Schottky barrier diodes are designed for high-speed switching applications, circuit protection, and voltage clamping. Extremely low forward voltage reduces conduction. Miniature surface mount package is excellent for hand-held and portable applications where space is limited.

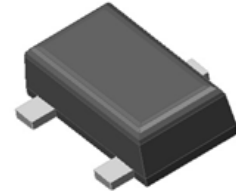

SOT-323F



### Features and Benefits

- Low forward drop voltage and low leakage current
- Very low switching time
- Full lead (Pb)-free device and RoHS compliant device
- Available in "Green" device

### Applications

- General purpose and high speed switching
- Protection circuit and voltage clamping

### Ordering Information

Part Number	Marking Code	Package	Packaging
SDB310WKUF	DB8 □	SOT-323F	Tape & Reel

### Marking Information

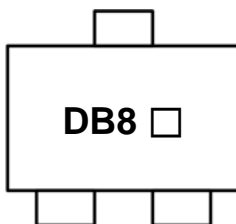

DB8 = Specific Device Code

□ = Year & Week Code Marking

### Pinning Information

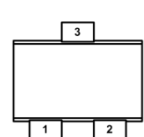
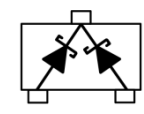
Pin	Description	Simplified Outline	Graphic Symbol
1	Anode (Diode 1)		
2	Anode (Diode 2)		
3	Common Cathode		

## Absolute Maximum Ratings (T<sub>amb</sub>=25°C, Unless otherwise specified)

Characteristic	Symbol	Ratings	Unit
Peak reverse voltage	V <sub>RM</sub>	40	V
DC reverse voltage	V <sub>R</sub>	30	V
Repetitive peak forward current	I <sub>FRM</sub>	0.5	A
Forward current	I <sub>F</sub>	0.2	A
Non-repetitive peak forward surge current(t=10ms)	I <sub>FSM</sub>	2	A
Power dissipation <sup>1)</sup>	P <sub>D</sub>	150	mW

<sup>1)</sup> Device mounted on FR-4 board with recommended pad layout.

## Thermal Characteristics (T<sub>amb</sub>=25°C, Unless otherwise specified)

Characteristic	Symbol	Ratings	Unit
Thermal resistance, junction to ambient <sup>1)</sup>	R <sub>th(j-a)</sub>	833	°C/W
Operating junction temperature	T <sub>j</sub>	150	°C
Storage temperature range	T <sub>stg</sub>	-55 ~ 150	°C

<sup>1)</sup> Device mounted on FR-4 board with recommended pad layout.

## Electrical Characteristics (T<sub>amb</sub>=25°C, Unless otherwise specified)

Characteristic	Symbol	Test Condition	Min.	Typ.	Max.	Unit
Forward voltage <sup>2)</sup>	V <sub>F(1)</sub>	I <sub>F</sub> =10mA	-	-	0.4	V
	V <sub>F(2)</sub>	I <sub>F</sub> =30mA	-	-	0.5	V
Reverse leakage current <sup>3)</sup>	I <sub>R</sub>	V <sub>R</sub> =30V	-	-	1	μA
Total capacitance	C <sub>T</sub>	V <sub>R</sub> =1V, f=1MHz	-	-	10	pF
Reverse recovery time	t <sub>rr</sub>	I <sub>F</sub> = I <sub>R</sub> =10mA, I <sub>R(REC)</sub> = 1mA	-	-	5	ns

<sup>2)</sup> Pulse test: t<sub>p</sub>≤380μs, Duty cycle≤2%

<sup>3)</sup> Pulse test: t<sub>p</sub>≤5ms, Duty cycle≤2%

## Rating and Characteristic Curves

Fig. 1) Typical Forward Characteristics

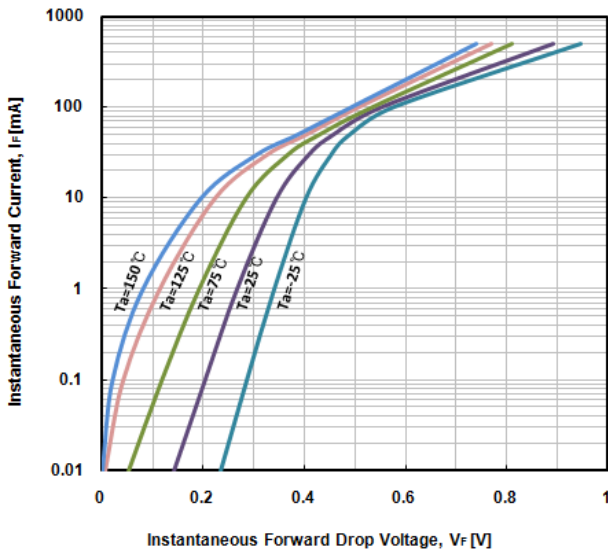

Fig. 2) Typical Reverse Characteristics

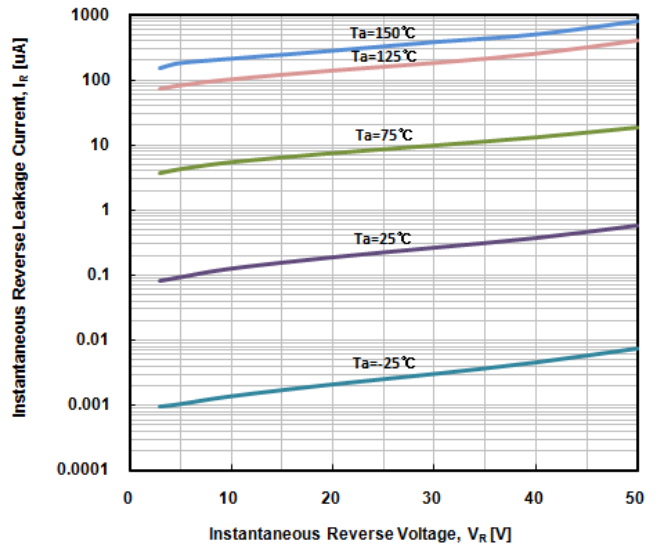

Fig. 3) Typical Total Capacitance Characteristics

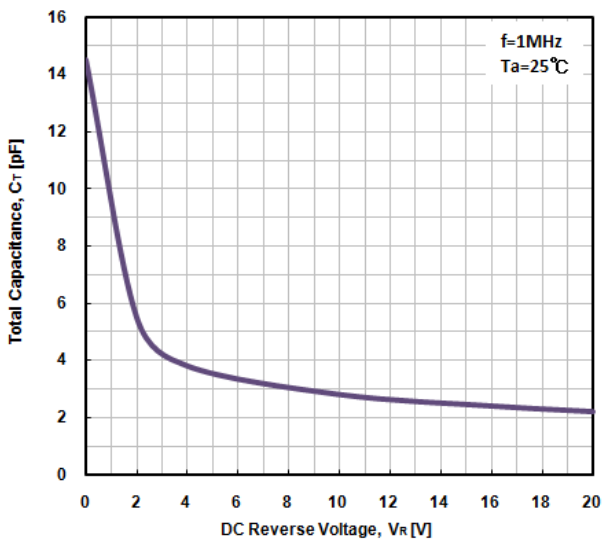

Fig. 4) Power dissipation vs. Ambient temperature

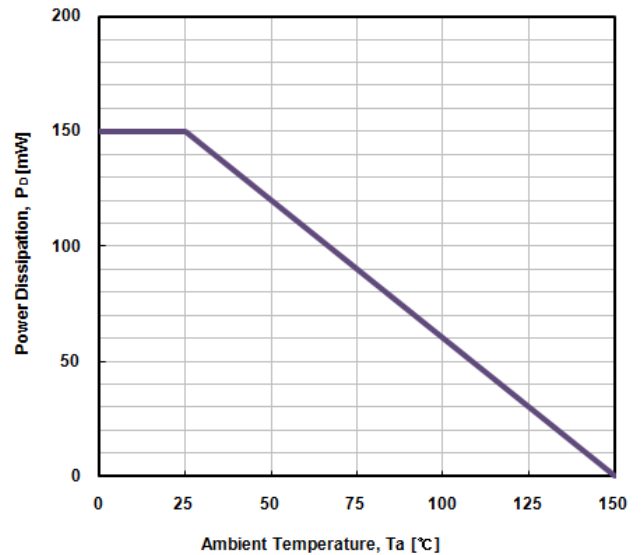
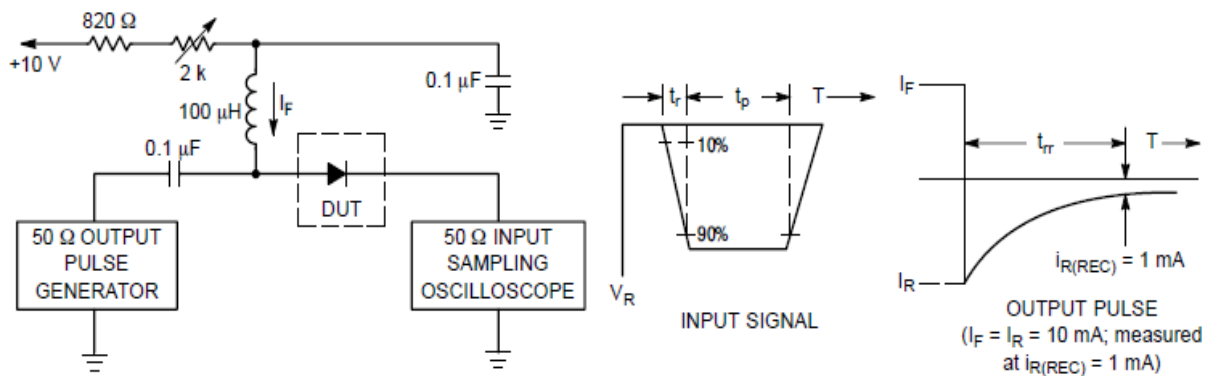
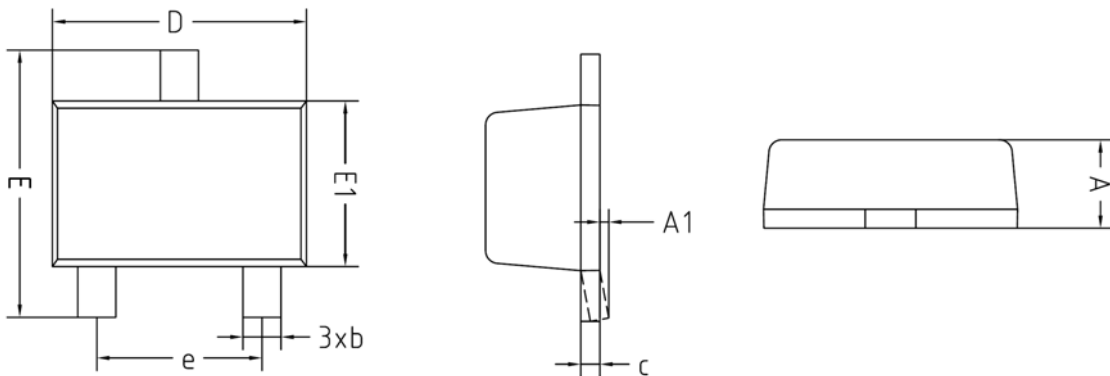

Fig. 5) Reverse recovery time equivalent test circuit



## Package Outline Dimensions



SYMBOL	MILLIMETERS			NOTE
	MINIMUM	NOMINAL	MAXIMUM	
A	0.60	-	0.80	
A1	0.00	-	0.10	
b	0.30	-	0.40	
c	0.08	-	0.16	
D	1.90	2.00	2.10	
E	1.95	2.10	2.25	
E1	1.20	1.30	1.40	
e	1.30BSC			

※ Recommend PCB solder land (Unit : mm)

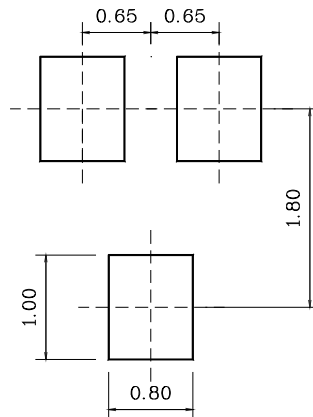

**The AUK Corp. products are intended for the use as components in general electronic equipment (Office and communication equipment, measuring equipment, home appliance, etc.).**

**Please make sure that you consult with us before you use these AUK Corp. products in equipments which require high quality and / or reliability, and in equipments which could have major impact to the welfare of human life(atomic energy control, airplane, spaceship, transportation, combustion control, all types of safety device, etc.). AUK Corp. cannot accept liability to any damage which may occur in case these AUK Corp. products were used in the mentioned equipments without prior consultation with AUK Corp..**

**Specifications mentioned in this publication are subject to change without notice.**