

General Purpose Schottky Barrier Diode

General Description

The SDB310D Schottky barrier diodes are designed for high-speed switching applications, circuit protection, and voltage clamping. Extremely low forward voltage reduces conduction. Miniature surface mount package is excellent for hand-held and portable applications where space is limited.

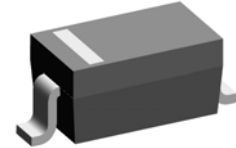

SOD-323

Features and Benefits

- Low forward drop voltage and low leakage current
- Very low switching time
- “Green” device and RoHS compliant device
- Available in full lead (Pb)-free device



Applications

- General purpose and high speed switching
- Protection circuit and voltage clamping

Ordering Information

Part Number	Marking Code	Package	Packaging
SDB310D	B1 □	SOD-323	Tape & Reel

Marking Information

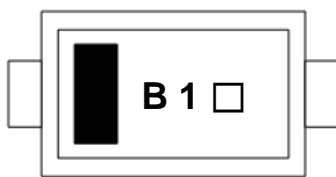

B 1 = Specific Device Code

□ = Year & Week Code Marking

■ = Color band denote cathode

Pinning Information

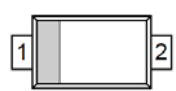
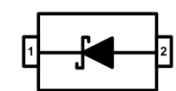
Pin	Description	Simplified Outline	Graphic Symbol
1	Cathode		
2	Anode		

Absolute Maximum Ratings ($T_{amb}=25^{\circ}\text{C}$, Unless otherwise specified)

Characteristic	Symbol	Ratings	Unit
Peak reverse voltage	V_{RM}	40	V
DC reverse voltage	V_R	30	V
Repetitive peak forward current	I_{FRM}	0.5	A
Forward current	I_F	0.2	A
Non-repetitive peak forward surge current($t=10\text{ms}$)	I_{FSM}	2	A
Power dissipation ¹⁾	P_D	150	mW

¹⁾ Device mounted on FR-4 board with recommended pad layout.

Thermal Characteristics ($T_{amb}=25^{\circ}\text{C}$, Unless otherwise specified)

Characteristic	Symbol	Ratings	Unit
Thermal resistance, junction to ambient ¹⁾	$R_{th(j-a)}$	833	$^{\circ}\text{C}/\text{W}$
Operating junction temperature	T_j	150	$^{\circ}\text{C}$
Storage temperature range	T_{stg}	-55 ~ 150	$^{\circ}\text{C}$

¹⁾ Device mounted on FR-4 board with recommended pad layout.

Electrical Characteristics ($T_{amb}=25^{\circ}\text{C}$, Unless otherwise specified)

Characteristic	Symbol	Test Condition	Min.	Typ.	Max.	Unit
Forward voltage ²⁾	$V_{F(1)}$	$I_F=10\text{mA}$	-	-	0.4	V
	$V_{F(2)}$	$I_F=30\text{mA}$	-	-	0.5	V
Reverse leakage current ³⁾	I_R	$V_R=30\text{V}$	-	-	1	μA
Total capacitance	C_T	$V_R=1\text{V}$, $f=1\text{MHz}$	-	-	10	pF
Reverse recovery time	t_{rr}	$I_F=I_R=10\text{mA}$, $I_{R(REC)}=1\text{mA}$	-	-	5	ns

²⁾ Pulse test: $t_p \leq 380\mu\text{s}$, Duty cycle $\leq 2\%$

³⁾ Pulse test: $t_p \leq 5\text{ms}$, Duty cycle $\leq 2\%$

Rating and Characteristic Curves

Fig. 1) Typical Forward Characteristics

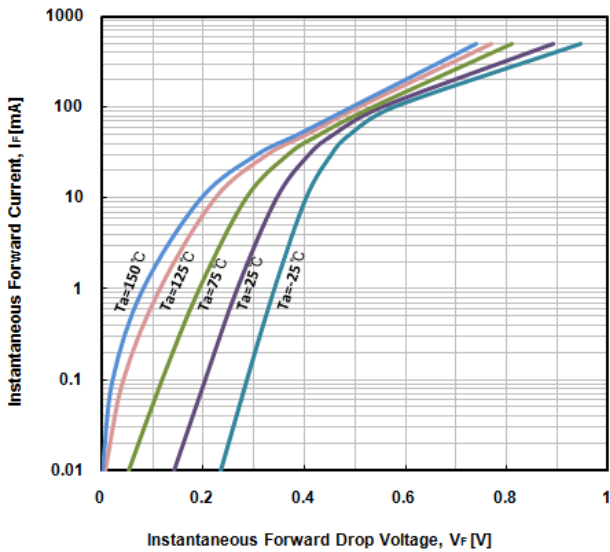

Fig. 2) Typical Reverse Characteristics

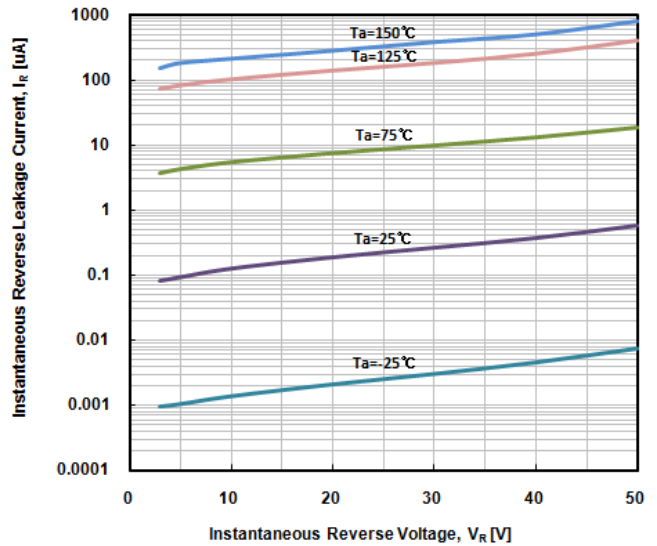

Fig. 3) Typical Total Capacitance Characteristics

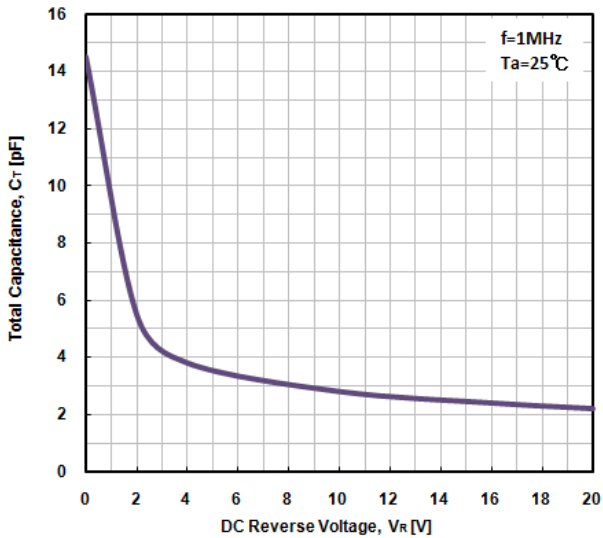

Fig. 4) Power dissipation vs. Ambient temperature

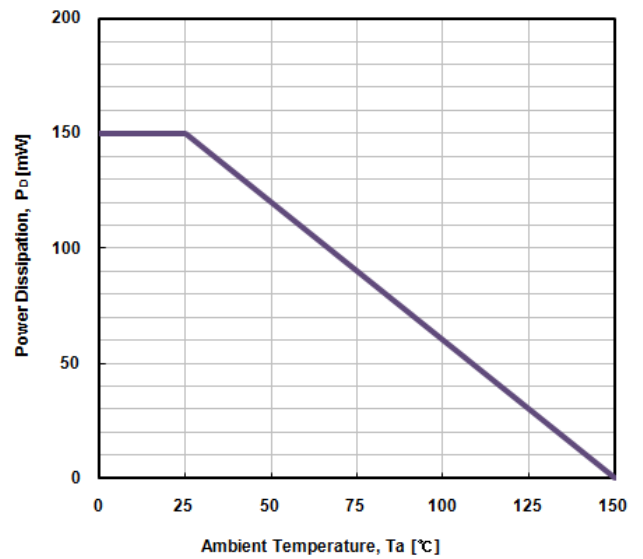
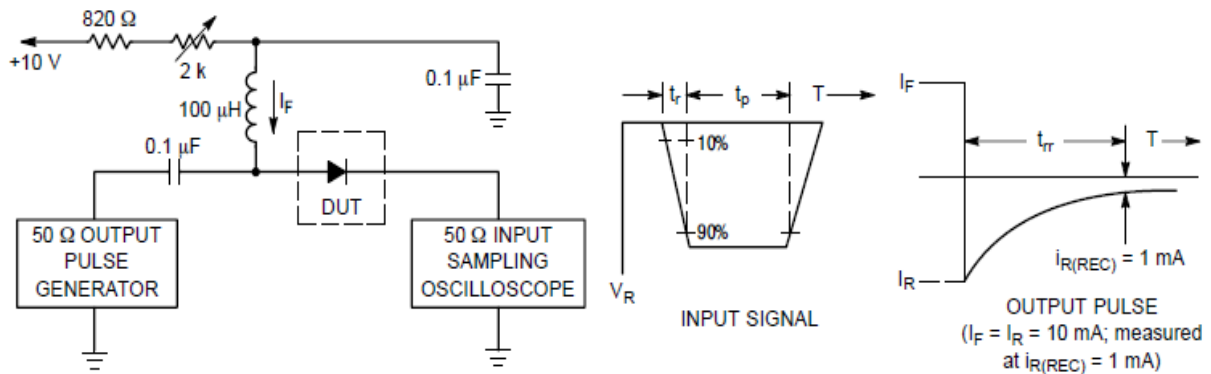
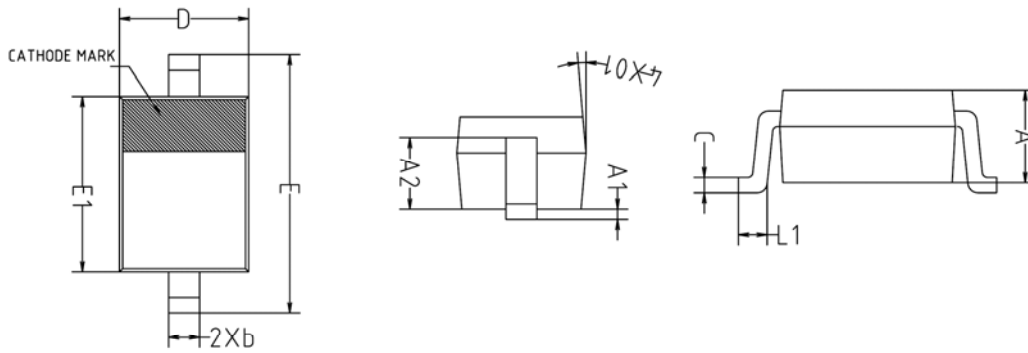

Fig. 5) Reverse recovery time equivalent test circuit



Package Outline Dimensions



SYMBOL	MILLIMETERS			NOTE
	MINIMUM	NOMINAL	MAXIMUM	
A	0.850	-	0.950	
A1	0.000	-	0.100	
A2	0.650	0.700	0.750	
b	0.250	0.300	0.350	
c	0.110	0.150	0.190	
D	1.200	1.250	1.300	
E	2.400	2.500	2.600	
E1	1.650	1.700	1.750	
L1	0.200	-	0.300	
∅2	5° REF			

※ Recommend PCB solder land (Unit : mm)

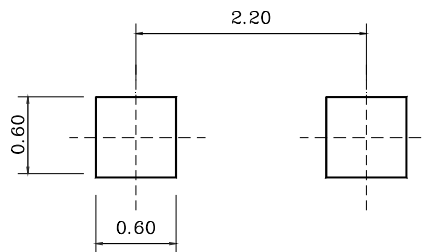

The AUK Corp. products are intended for the use as components in general electronic equipment (Office and communication equipment, measuring equipment, home appliance, etc.).

Please make sure that you consult with us before you use these AUK Corp. products in equipments which require high quality and / or reliability, and in equipments which could have major impact to the welfare of human life(atomic energy control, airplane, spaceship, transportation, combustion control, all types of safety device, etc.). AUK Corp. cannot accept liability to any damage which may occur in case these AUK Corp. products were used in the mentioned equipments without prior consultation with AUK Corp..

Specifications mentioned in this publication are subject to change without notice.