

DUAL COMMON CATHODE SCHOTTKY RECTIFIER

Features

- Low forward voltage drop
- Low power loss and High efficiency
- Low leakage current
- High surge capacity
- Full lead (Pb)-free and RoHS compliant device

Applications

- High efficiency SMPS
- Output rectification
- High frequency switching
- Freewheeling
- DC-DC converter systems

Description

The SDB20D60D2 is suited for Switch Mode Power Supply and high frequency DC to DC converters. This device is especially intended for use in low voltage, high frequency inverters, free wheeling and polarity protection applications.

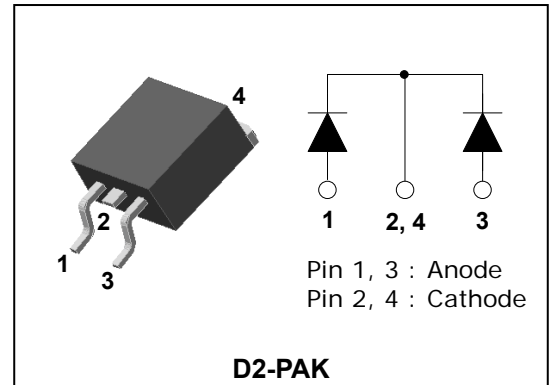

Product Characteristics

$I_{F(AV)}$	2 X 10A
V_{RRM}	60V
V_{FM} at 125°C	0.55V
I_{FSM}	150A

Ordering Information

Device	Marking Code	Package	Packaging
SDB20D60D2	SDB20D60D2	D2-PAK	Tape & Reel

Marking Information

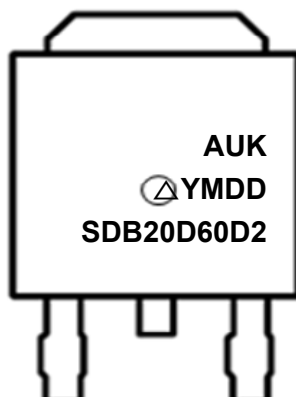

AUK = Manufacture Logo

Δ = Control Code of Manufacture

YMDD = Date Code Marking

- Y = Year Code

- M = Monthly Code

- D = Daily Code

SDB20D60D2 = Specific Device Code

Absolute Maximum Ratings (Limiting Values)

Characteristic		Symbol	Value	Unit
Maximum repetitive reverse voltage Maximum working peak reverse voltage Maximum DC blocking voltage		V_{RRM} V_{RWM} V_R	60	V
Maximum average forward rectified current	per diode	$I_{F(AV)}$	10	A
	total device		20	
Peak forward surge current 8.3ms single half sine-wave superimposed on rated load per diode		I_{FSM}	150	A
Storage temperature range		T_{stg}	-55 to +150	°C
Maximum operating junction temperature		T_j	150	

Thermal Characteristics

Characteristic		Symbol	Value	Unit
Maximum thermal resistance junction to case	per diode	$R_{th(j-c)}$	3.0	°C/W
	total device		2.8	

Electrical Characteristics

Characteristic	Symbol	Test Condition	Min.	Typ.	Max.	Unit	
Peak forward voltage drop	$V_{FM}^{(1)}$	$I_{FM} = 10A$	$T_j = 25^\circ C$	-	0.55	0.65	V
			$T_j = 125^\circ C$	-	0.50	0.55	
Reverse leakage current	$I_{RM}^{(1)}$	$V_R = V_{RRM}$	$T_j = 25^\circ C$	-	-	1.5	mA
			$T_j = 125^\circ C$	-	-	200	
Junction capacitance	C_j	$V_R = 4V_{DC}, f=1MHz$	-	400	-	pF	

Note : (1) Pulse test : $t_p \leq 380\mu s$, Duty cycle $\leq 2\%$

To evaluate the conduction losses use the following equation: $P_F = 0.35 I_{F(AV)} + 0.019 I_{F(RMS)}^2$

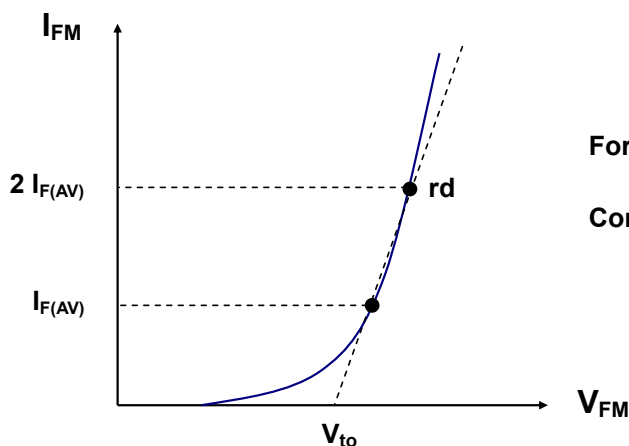

Forward Voltage : $V_{FM} = V_{to} + rd I_{FM}$

Conduction Loss : $P_F = V_{to} I_{F(AV)} + rd I_{F(RMS)}^2$

Rating and Characteristic Curves

Fig. 1) Typical Forward Characteristics (Per Diode)

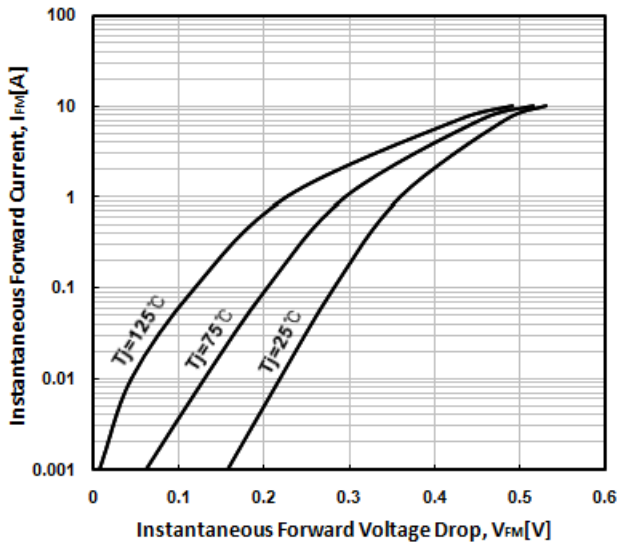

Fig. 2) Typical Reverse Characteristics (Per Diode)

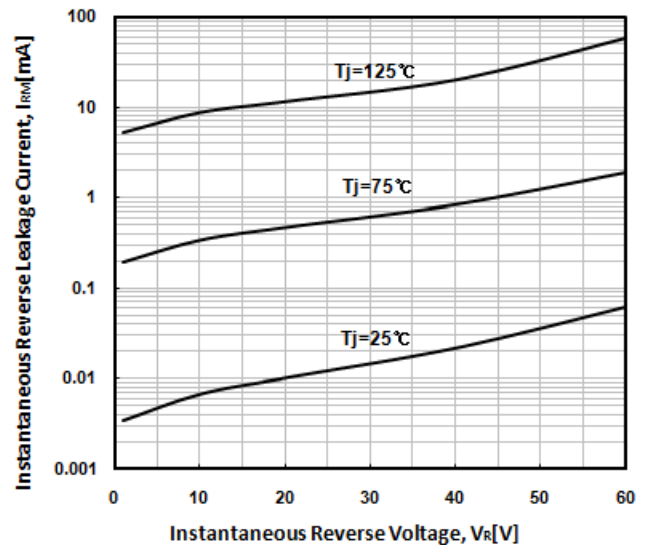

Fig. 3) Maximum Forward Derivative Curve

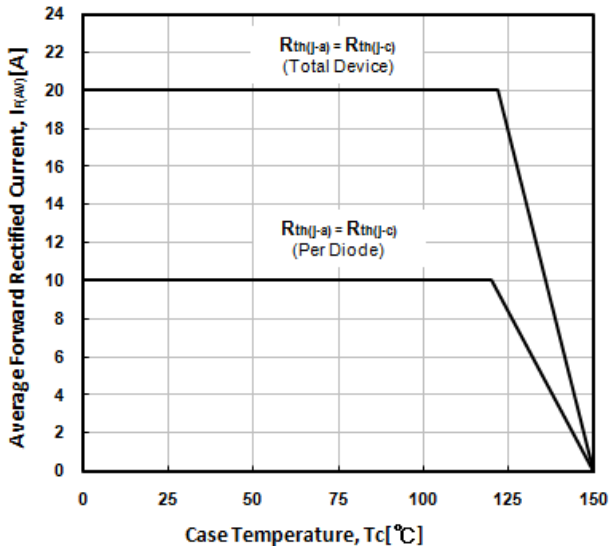

Fig. 4) Forward Power Dissipation (Per Diode)

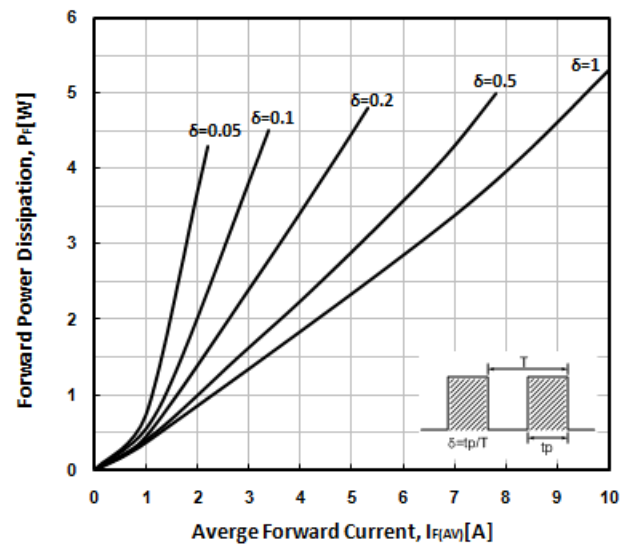

Fig. 5) Maximum Non-Repetitive Peak Forward Surge Current (Per Diode)

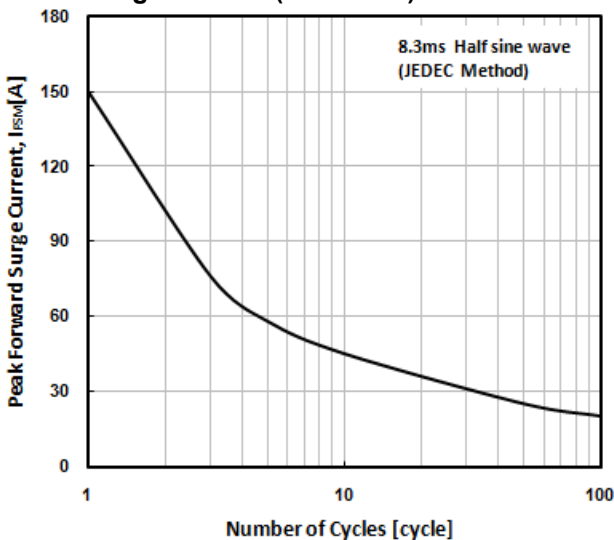
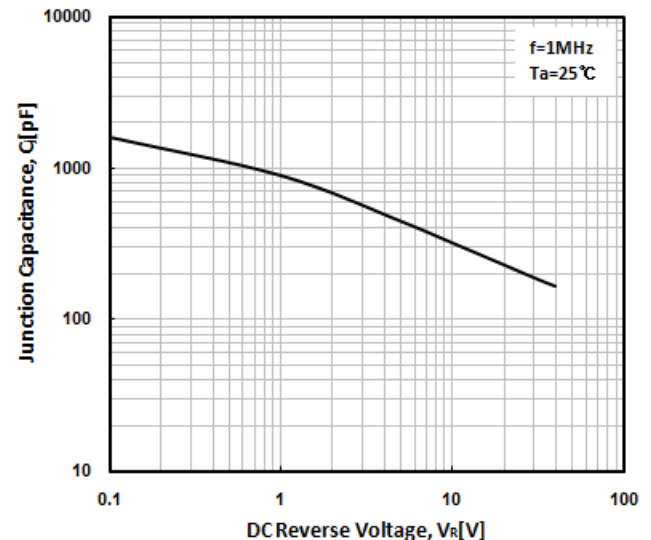
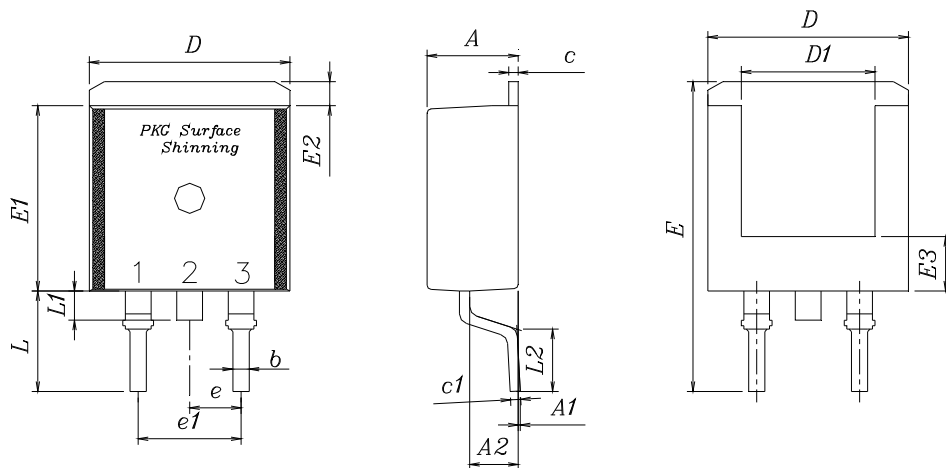

Fig. 6) Typical Junction Capacitance (Per Diode)



Package Outline Dimension (Unit: mm)



SYMBOL	MILLIMETERS			NOTE
	MINIMUM	NOMINAL	MAXIMUM	
A	4.35	4.50	4.65	
A1	—	—	0.15	
A2	2.20	2.40	2.60	
b	0.70	0.80	0.90	
c	0.40	0.50	0.60	
c1	0.40	0.50	0.60	
D	9.80	10.00	10.20	
D1	6.40	6.60	6.80	
E	15.00	15.40	15.80	
E1	9.05	9.20	9.35	
E2	1.00	1.20	1.40	
E3	2.50	2.70	2.90	
e	2.34	2.54	2.74	
e1	4.88	5.08	5.28	
L	4.60	5.00	5.40	
L1	1.40	1.45	1.50	
L2	2.50	—	—	

※ Recommend PCB solder land (Unit: mm)

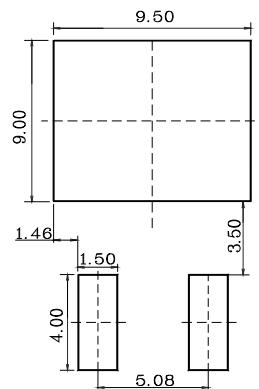

The AUK Corp. products are intended for the use as components in general electronic equipment (Office and communication equipment, measuring equipment, home appliance, etc.).

Please make sure that you consult with us before you use these AUK Corp. products in equipments which require high quality and / or reliability, and in equipments which could have major impact to the welfare of human life(atomic energy control, airplane, spaceship, transportation, combustion control, all types of safety device, etc.). AUK Corp. cannot accept liability to any damage which may occur in case these AUK Corp. products were used in the mentioned equipments without prior consultation with AUK Corp..

Specifications mentioned in this publication are subject to change without notice.