

DUAL COMMON CATHODE SCHOTTKY RECTIFIER

Features

- Low forward voltage drop and leakage current
- Low power loss and High efficiency
- High surge capability
- Dual common cathode rectifier
- Halogen-free component and RoHS compliant device

Applications

- Power supply - Output rectification
- Converter
- Free-wheeling diode
- Reverse battery protection
- Power inverters

Description

The SDB10D150D2 has two schottky barriers arranged in a common cathode configuration. Typical applications are in switching power supplies, converters, free-wheeling diodes, and reverse battery protection.

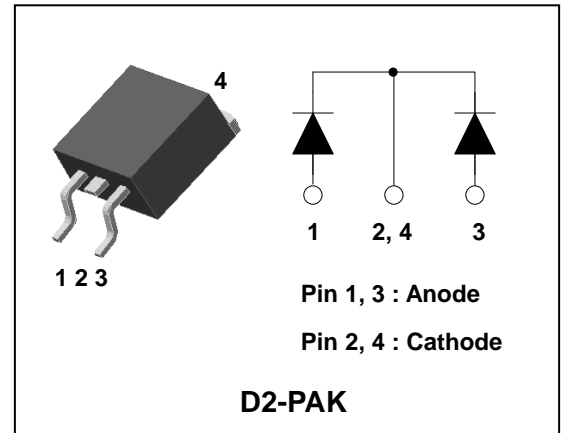

Product Characteristics

$I_{F(AV)}$	2 X 5A
V_{RRM}	150V
V_{FM} at 125°C	0.75V
I_{FSM}	120A

Ordering Information

Device	Marking Code	Package	Packaging
SDB10D150D2	SDB10D150D2	D2-PAK	Tape & Reel

Marking Information

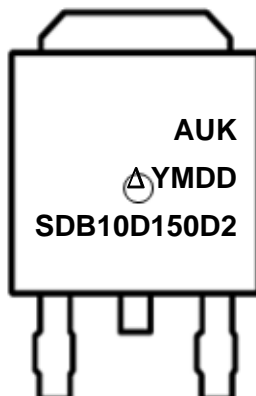

AUK = Manufacture Logo

Δ = Control Code of Manufacture

YMDD = Date Code Marking

-. Y = Year Code

-. M = Monthly Code

-. DD = Daily Code

SDB10D150D2 = Specific Device Code

Absolute Maximum Ratings (Limiting Values)

Characteristic	Symbol	Value	Unit
Maximum repetitive reverse voltage Maximum working peak reverse voltage Maximum DC blocking voltage	V_{RRM} V_{RWM} V_R	150	V
Maximum average forward rectified current	per diode	5	A
	total device	10	
Peak forward surge current 8.3ms single half sine-wave superimposed on rated load per diode	I_{FSM}	120	A
Storage temperature range	T_{stg}	-45°C to +150°C	°C
Maximum operating junction temperature	T_j	150	°C

Thermal Characteristics

Characteristic	Symbol	Value	Unit
Maximum thermal resistance junction to case	per diode	3.5	°C/W
	total device	3.3	

Electrical Characteristics (Per Diode)

Characteristic	Symbol	Test Condition	Min.	Typ.	Max.	Unit	
Peak forward voltage drop	$V_{FM}^{(1)}$	$I_{FM} = 5A$	$T_j = 25^\circ C$	-	-	0.88	V
			$T_j = 125^\circ C$	-	-	0.75	V
Reverse leakage current	$I_{RM}^{(1)}$	$V_R = V_{RRM}$	$T_j = 25^\circ C$	-	-	10	uA
			$T_j = 125^\circ C$	-	-	10	mA
Junction capacitance	C_j	$V_R = 4V_{DC}, f=1MHz$	-	80	-	pF	

Note : (1) Pulse test : $t_p \leq 380 \mu s$, Duty cycle $\leq 2\%$

To evaluate the conduction losses use the following equation (Fig 4.) : $P_F = 0.72 \times I_{F(AV)} + 0.021 I_{F(RMS)}^2$

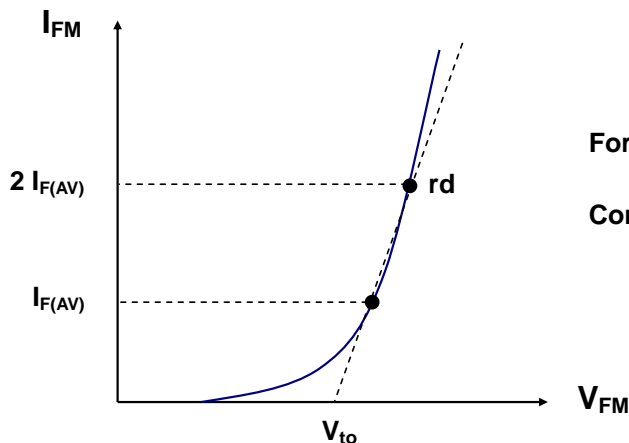

Forward Voltage: $V_{FM} = V_{to} + rd I_{FM}$

Conduction Loss: $P_F = V_{to} I_{F(AV)} + rd I_{F(RMS)}^2$

Rating and Characteristic Curves

Fig. 1) Typical Forward Characteristics (Per diode)

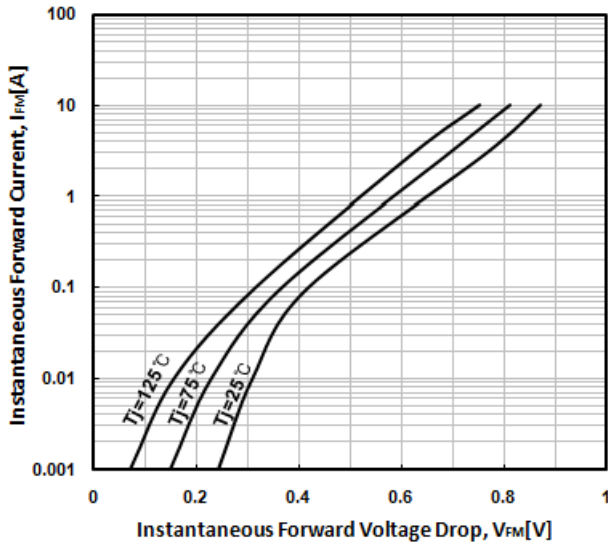

Fig. 2) Typical Reverse Characteristics (Per diode)

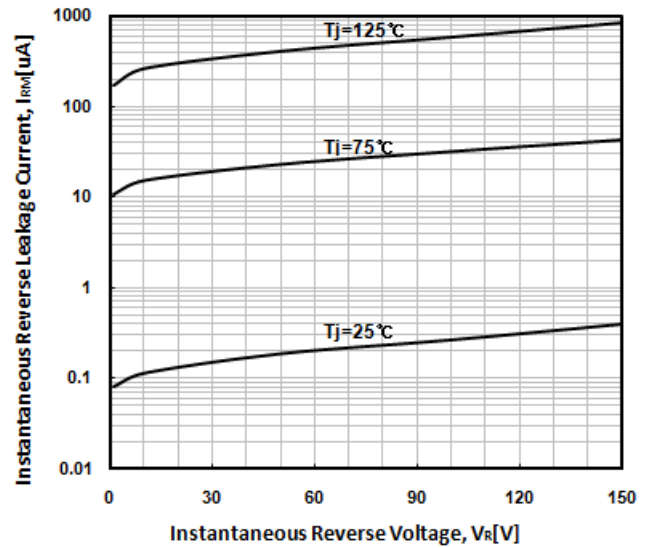

Fig. 3) Maximum Forward Derivative Curve

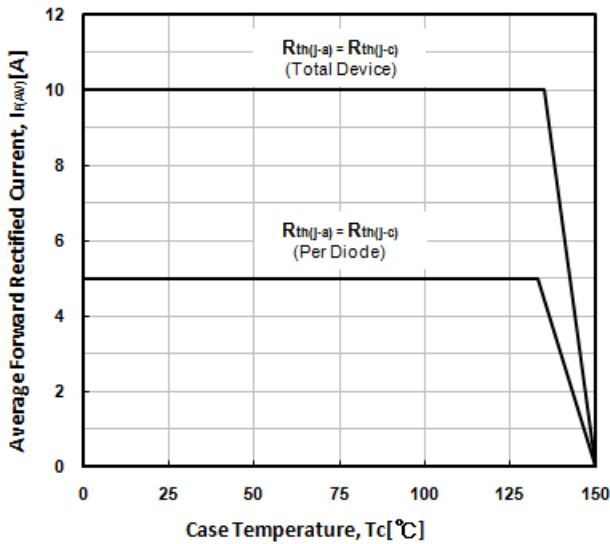

Fig. 4) Forward Power Dissipation (Per diode)

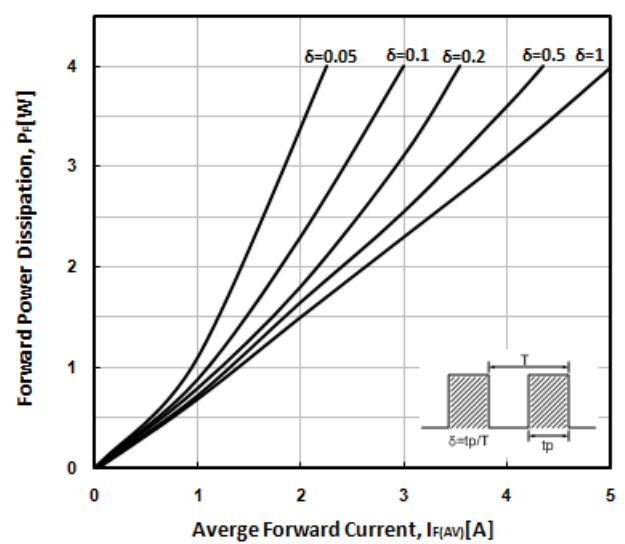

Fig. 5) Maximum Non-Repetitive Peak Forward Surge Current (Per diode)

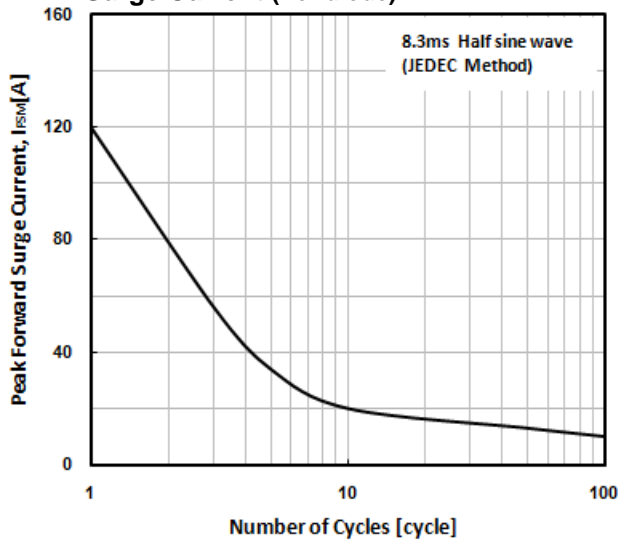
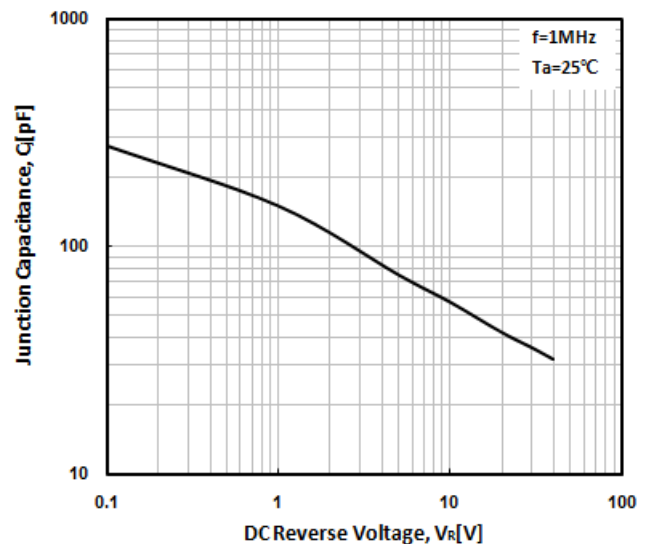
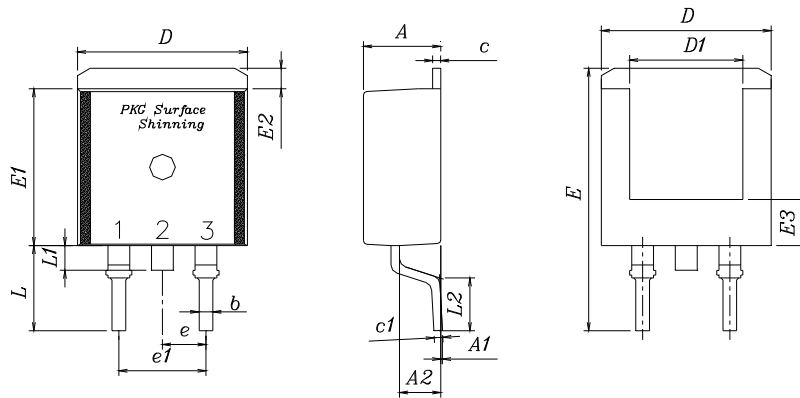

Fig. 6) Typical Junction Capacitance (Per diode)



Package Outline Dimension



SYMBOL	MILLIMETERS			NOTE
	MINIMUM	NOMINAL	MAXIMUM	
A	4.35	4.50	4.65	
A1	—	—	0.15	
A2	2.20	2.40	2.60	
b	0.70	0.80	0.90	
c	0.40	0.50	0.60	
c1	0.40	0.50	0.60	
D	9.80	10.00	10.20	
D1	6.40	6.60	6.80	
E	15.00	15.40	15.80	
E1	9.05	9.20	9.35	
E2	1.00	1.20	1.40	
E3	2.50	2.70	2.90	
e	2.34	2.54	2.74	
e1	4.88	5.08	5.28	
L	4.60	5.00	5.40	
L1	1.40	1.45	1.50	
L2	2.50	—	—	

※ Recommended Land Pattern (unit: mm)

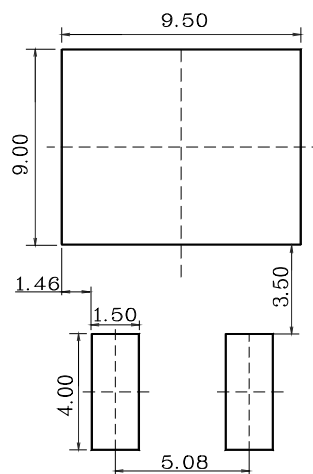

The AUK Corp. products are intended for the use as components in general electronic equipment (Office and communication equipment, measuring equipment, home appliance, etc.).

Please make sure that you consult with us before you use these AUK Corp. products in equipments which require high quality and / or reliability, and in equipments which could have major impact to the welfare of human life(atomic energy control, airplane, spaceship, transportation, combustion control, all types of safety device, etc.). AUK Corp. cannot accept liability to any damage which may occur in case these AUK Corp. products were used in the mentioned equipments without prior consultation with AUK Corp..

Specifications mentioned in this publication are subject to change without notice.