

## High Voltage Switching Diode

### General Description

Dual general-purpose switching diodes, fabricated in planar technology, and packaged in small SOT-23F surface mounted device (SMD) packages.

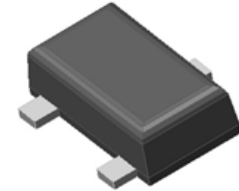

SOT-23F



### Features and Benefits

- Silicon epitaxial planar diode
- High switching speed
- Low forward drop voltage and low leakage current
- “Green” device and RoHS compliant device
- Available in full lead (Pb)-free device

### Applications

- Ultra high speed switching application

### Ordering Information

Part Number	Marking Code	Package	Packaging
SDS20WAF	J3A □	SOT-23F	Tape & Reel

### Marking Information

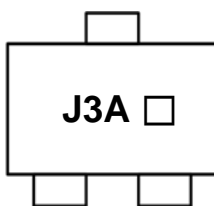

J3A = Specific Device Code

□ = Year & Week Code Marking

### Pinning Information

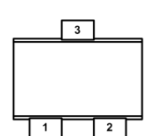
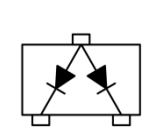
Pin	Description	Simplified Outline	Graphic Symbol
1	Cathode (Diode 1)		
2	Cathode (Diode 2)		
3	Common Anode		

## Absolute Maximum Ratings ( $T_{amb}=25^{\circ}\text{C}$ , Unless otherwise specified)

Characteristic	Symbol	Ratings	Unit
Maximum repetitive peak reverse voltage	$V_{RM}$	200	V
Continuous reverse voltage	$V_R$	150	V
Maximum average forward rectified current	$I_O$	200	mA
Maximum repetitive peak forward current	$I_{FM}$	400	mA
Non-repetitive peak forward surge current( $t=10\text{ms}$ )	$I_{FSM}$	1.7	A
Power dissipation <sup>1)</sup>	$P_D$	250	mW

<sup>1)</sup> Device mounted on FR-4 board with recommended pad layout.

## Thermal Characteristics ( $T_{amb}=25^{\circ}\text{C}$ , Unless otherwise specified)

Characteristic	Symbol	Ratings	Unit
Thermal resistance, junction to ambient <sup>1)</sup>	$R_{th(j-a)}$	500	$^{\circ}\text{C}/\text{W}$
Operating junction temperature	$T_j$	150	$^{\circ}\text{C}$
Storage temperature range	$T_{stg}$	-55 ~ 150	$^{\circ}\text{C}$

<sup>1)</sup> Device mounted on FR-4 board with recommended pad layout.

## Electrical Characteristics ( $T_{amb}=25^{\circ}\text{C}$ , Unless otherwise specified)

Characteristic	Symbol	Test Condition	Min.	Typ.	Max.	Unit
Reverse breakdown voltage	$V_{BR}$	$I_F=100\mu\text{A}$	200	-	-	V
Forward drop voltage <sup>2)</sup>	$V_F$	$I_F=100\text{mA}$	-	-	1.0	V
		$I_F=200\text{mA}$	-	-	1.25	V
Reverse leakage current <sup>3)</sup>	$I_R$	$V_R=150\text{V}$	-	-	100	nA
		$V_R=150\text{V}, T_a=150^{\circ}\text{C}$	-	-	100	$\mu\text{A}$
Total capacitance	$C_T$	$V_R=0\text{V}, f=1\text{MHz}$	-	-	5	pF
Reverse recovery time	$t_{rr}$	$I_F=I_R=30\text{mA}, I_{rr}=3\text{mA}, R_L=100\Omega$	-	-	50	ns

<sup>2)</sup> Pulse test:  $t_p \leq 380\mu\text{s}$ , Duty cycle  $\leq 2\%$

<sup>3)</sup> Pulse test:  $t_p \leq 5\text{ms}$ , Duty cycle  $\leq 2\%$

## Rating and Characteristic Curves

Fig. 1) Typical Forward Characteristics

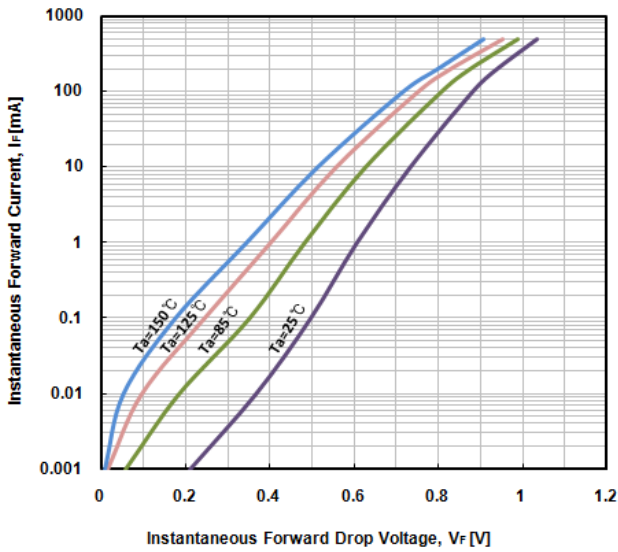

Fig. 2) Typical Reverse Characteristics

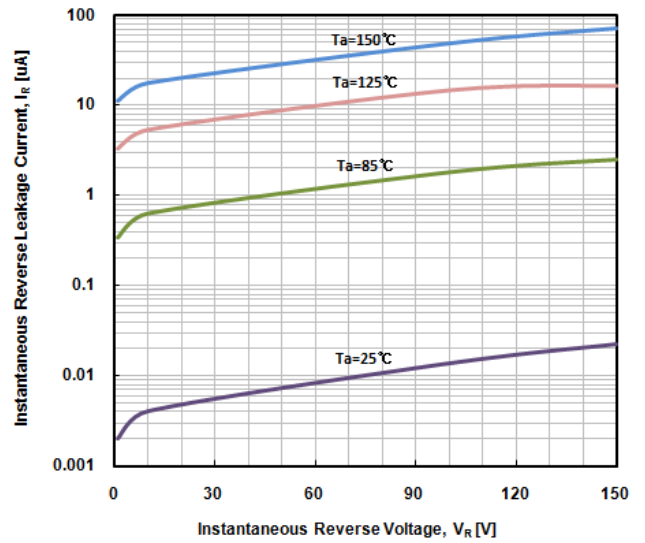

Fig. 3) Typical Total Capacitance Characteristics

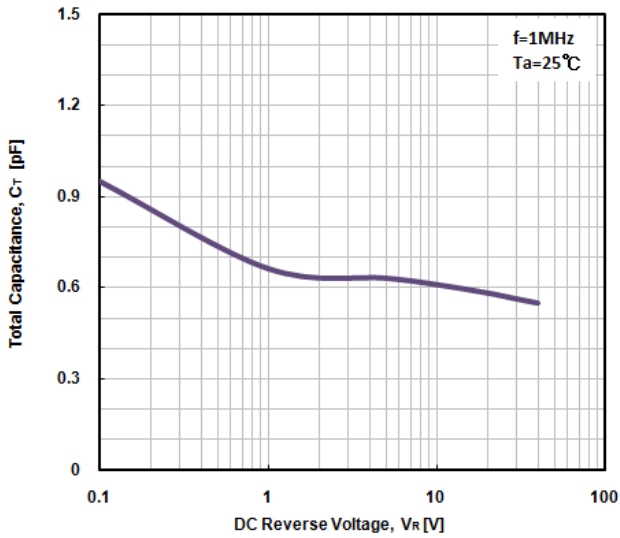

Fig. 4) Power Dissipation vs. Ambient Temperature

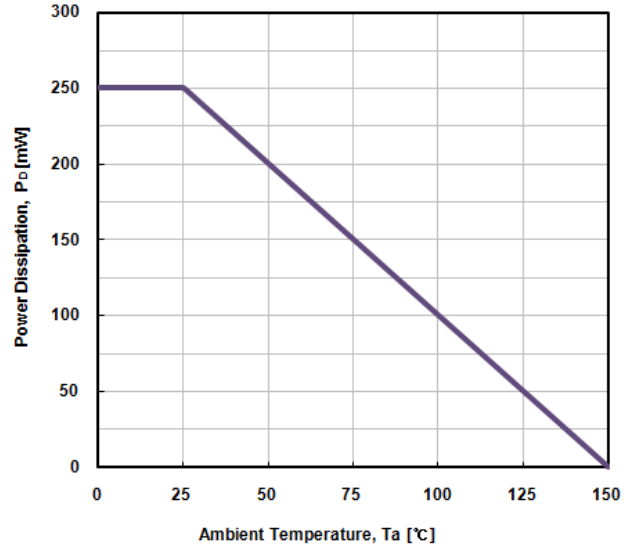
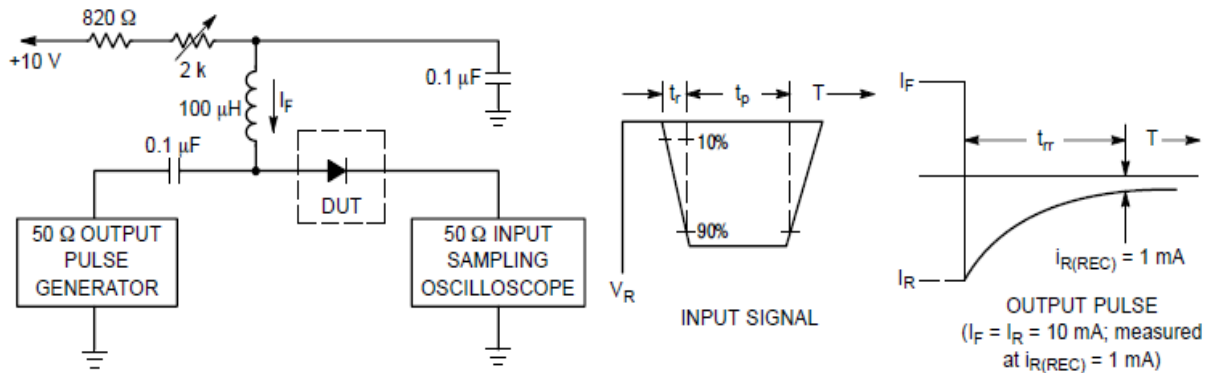
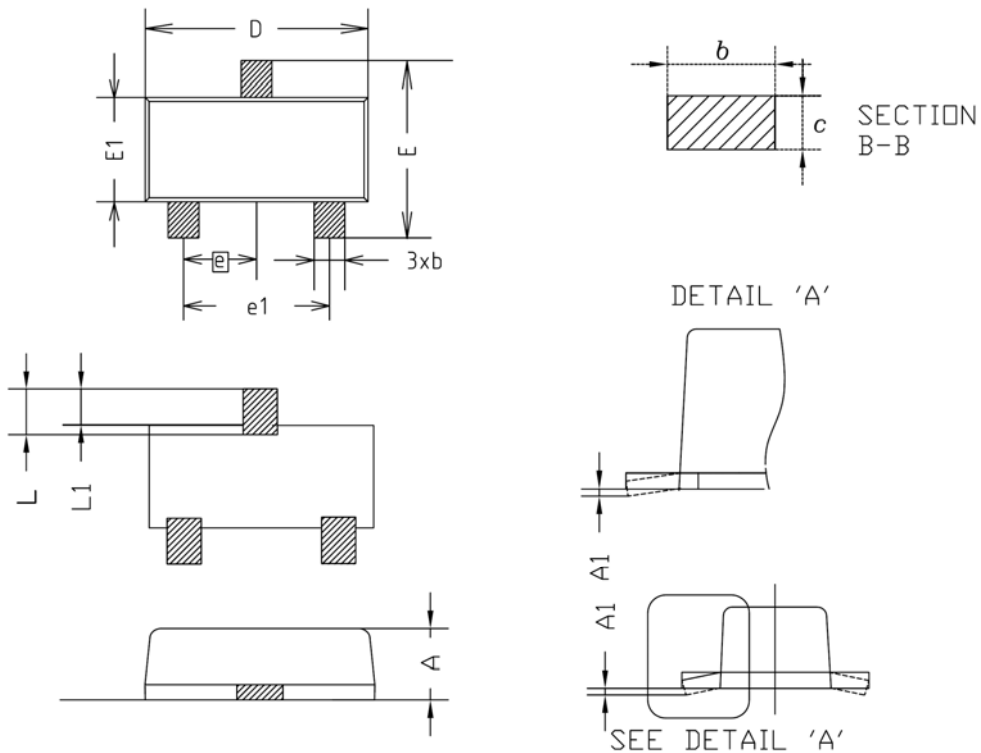

Fig. 5) Reverse recovery time equivalent test circuit



## Package Outline Dimensions



SYMBOL	MILLIMETER(mm)			NOTE
	MINIMUM	NOMINAL	MAXIMUM	
A	0.80	0.90	1.00	
A1	0.00	-	0.10	
b	0.35	0.40	0.45	
c	0.10	0.15	0.20	
D	2.80	2.90	3.00	
E	2.30	2.40	2.50	
E1	1.50	1.60	1.70	
e	0.95BSC			
e1	1.80	1.90	2.00	
L	0.48	0.58	0.68	
L1	0.30	-	0.50	

※ Recommend PCB solder land (Unit : mm)

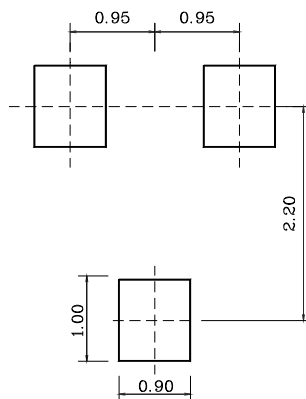

**The AUK Corp. products are intended for the use as components in general electronic equipment (Office and communication equipment, measuring equipment, home appliance, etc.).**

**Please make sure that you consult with us before you use these AUK Corp. products in equipments which require high quality and / or reliability, and in equipments which could have major impact to the welfare of human life(atomic energy control, airplane, spaceship, transportation, combustion control, all types of safety device, etc.). AUK Corp. cannot accept liability to any damage which may occur in case these AUK Corp. products were used in the mentioned equipments without prior consultation with AUK Corp..**

**Specifications mentioned in this publication are subject to change without notice.**