



CEPF634/CEBF634 CEIF634/CEFF634

N-Channel Enhancement Mode Field Effect Transistor

FEATURES

Type	V _{DSS}	R _{DS(ON)}	I _D	@V _{GS}
CEPF634	250V	0.45Ω	8.1A	10V
CEBF634	250V	0.45Ω	8.1A	10V
CEIF634	250V	0.45Ω	8.1A	10V
CEFF634	250V	0.45Ω	8.1A ^d	10V

- Super high dense cell design for extremely low R_{DS(ON)}.
- High power and current handling capability.
- Lead free product is acquired.
- TO-220 & TO-263 & TO-262 package & TO-220F full-pak for through hole.

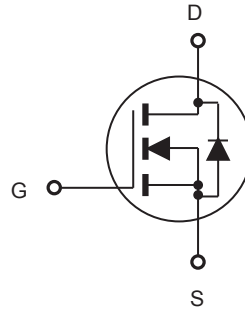
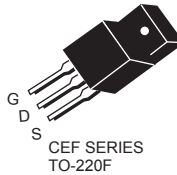

ABSOLUTE MAXIMUM RATINGS $T_C = 25^\circ\text{C}$ unless otherwise noted

Parameter	Symbol	Limit		Units
		TO-220/263/262	TO-220F	
Drain-Source Voltage	V _{DS}	250		V
Gate-Source Voltage	V _{GS}	±30		V
Drain Current-Continuous	I _D	8.1	8.1 ^d	A
Drain Current-Pulsed ^a	I _{DM} ^e	32	32 ^d	A
Maximum Power Dissipation @ T _C = 25°C - Derate above 25°C	P _D	74	38	W
		0.59	0.3	W/°C
Operating and Store Temperature Range	T _J , T _{stg}	-55 to 150		°C

Thermal Characteristics

Parameter	Symbol	Limit		Units
Thermal Resistance, Junction-to-Case	R _{θJC}	1.7	3.3	°C/W
Thermal Resistance, Junction-to-Ambient	R _{θJA}	62.5	65	°C/W



CEPF634/CEBF634 CEIF634/CEFF634

Electrical Characteristics $T_C = 25^\circ\text{C}$ unless otherwise noted

Parameter	Symbol	Test Condition	Min	Typ	Max	Units
Off Characteristics						
Drain-Source Breakdown Voltage	BV_{DSS}	$V_{GS} = 0V, I_D = 250\mu A$	250			V
Zero Gate Voltage Drain Current	I_{DSS}	$V_{DS} = 250V, V_{GS} = 0V$			25	μA
Gate Body Leakage Current, Forward	I_{GSSF}	$V_{GS} = 30V, V_{DS} = 0V$			100	nA
Gate Body Leakage Current, Reverse	I_{GSSR}	$V_{GS} = -30V, V_{DS} = 0V$			-100	nA
On Characteristics^b						
Gate Threshold Voltage	$V_{GS(th)}$	$V_{GS} = V_{DS}, I_D = 250\mu A$	2		4	V
Static Drain-Source On-Resistance	$R_{DS(on)}$	$V_{GS} = 10V, I_D = 4.5A$			0.45	Ω
Forward Transconductance	g_{FS}	$V_{DS} = 50V, I_D = 5.1A$		4.4		S
Dynamic Characteristics^c						
Input Capacitance	C_{iss}	$V_{DS} = 25V, V_{GS} = 0V, f = 1.0\text{ MHz}$		925		pF
Output Capacitance	C_{oss}			95		pF
Reverse Transfer Capacitance	C_{rss}			20		pF
Switching Characteristics^c						
Turn-On Delay Time	$t_{d(on)}$	$V_{DD} = 125V, I_D = 5.6A, V_{GS} = 10V, R_{GEN} = 12\Omega$		16	32	ns
Turn-On Rise Time	t_r			3.5	7	ns
Turn-Off Delay Time	$t_{d(off)}$			38	76	ns
Turn-Off Fall Time	t_f			4	8	ns
Total Gate Charge	Q_g	$V_{DS} = 200V, I_D = 5.6A, V_{GS} = 10V$		18	23	nC
Gate-Source Charge	Q_{gs}			3		nC
Gate-Drain Charge	Q_{gd}			5		nC
Drain-Source Diode Characteristics and Maximum Ratings						
Drain-Source Diode Forward Current	I_S^f				8.1	A
Drain-Source Diode Forward Voltage ^b	V_{SD}	$V_{GS} = 0V, I_S = 8.1A$		0.9	1.5	V
Notes : □ a.Repetitive Rating : Pulse width limited by maximum junction temperature . b.Pulse Test : Pulse Width $\leq 300\mu s$, Duty Cycle $\leq 2\%$. □ c.Guaranteed by design, not subject to production testing. □ d.Limited only by maximum temperature allowed . e .Pulse width limited by safe operating area . f .Full package $I_{S(max)} = 6A$. g .UIS condition $V_{dd}=25V$ $L=2mH$ $R_g=25ohm$ $I_{as}=8.1A$.						



CEPF634/CEBF634 CEIF634/CEFF634

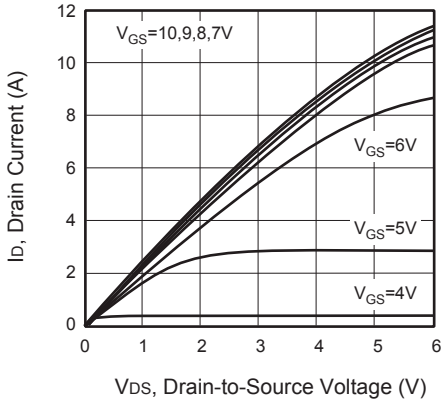

Figure 1. Output Characteristics

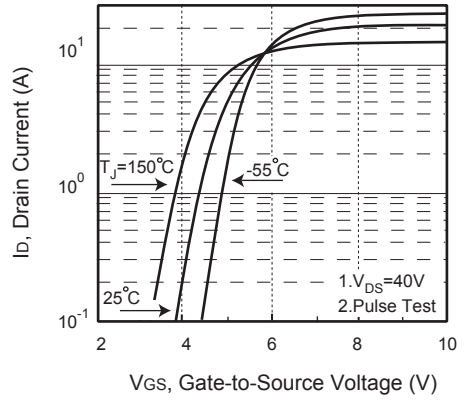

Figure 2. Transfer Characteristics

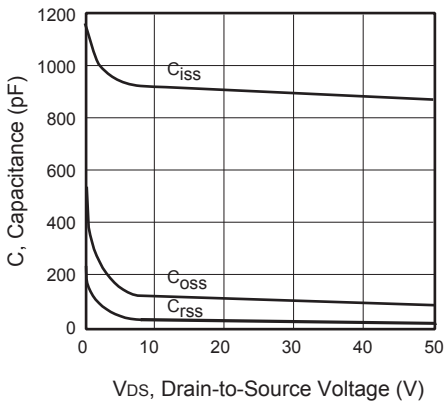

Figure 3. Capacitance

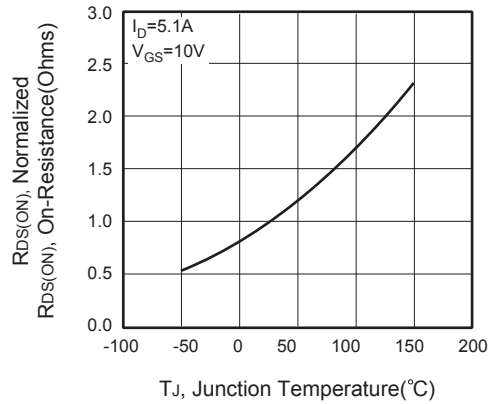

Figure 4. On-Resistance Variation with Temperature

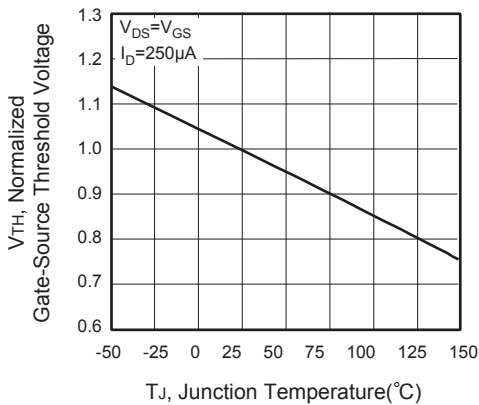

Figure 5. Gate Threshold Variation with Temperature

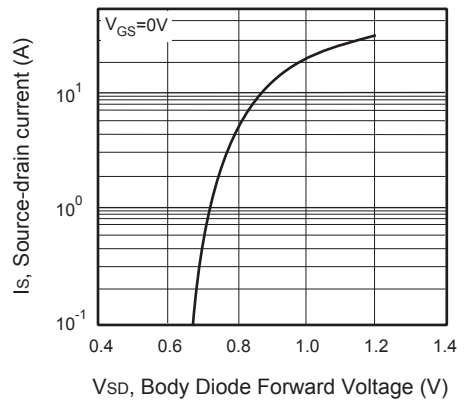

Figure 6. Body Diode Forward Voltage Variation with Source Current



CEPF634/CEBF634 CEIF634/CEFF634

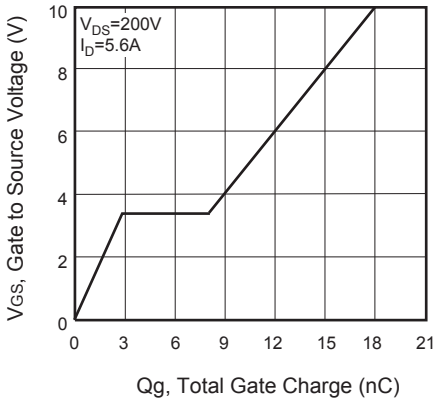

Figure 7. Gate Charge

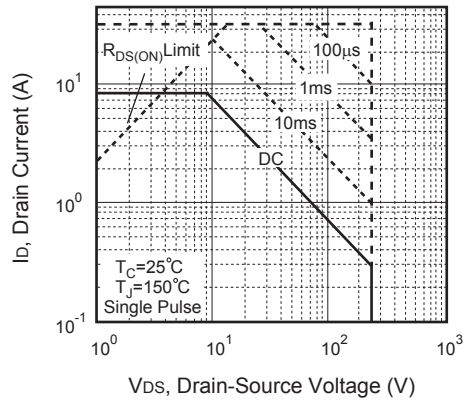

Figure 8. Maximum Safe Operating Area

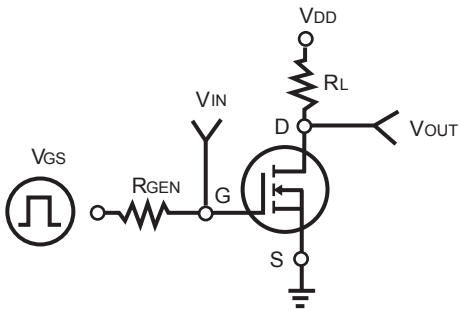

Figure 9. Switching Test Circuit



Figure 10. Switching Waveforms

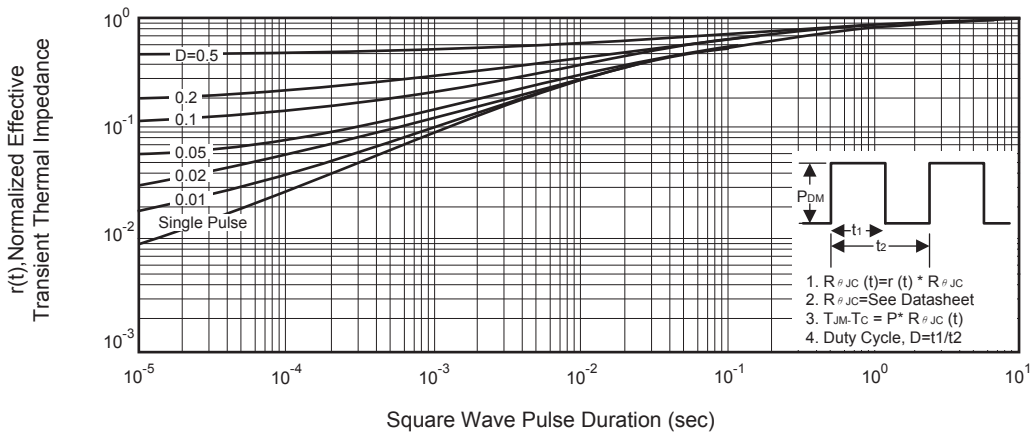

Figure 11. Normalized Thermal Transient Impedance Curve