



# CEP830G/CEB830G

## CEF830G

### N-Channel Enhancement Mode Field Effect Transistor

PRELIMINARY

### FEATURES

Type	V <sub>DSS</sub>	R <sub>DS(ON)</sub>	I <sub>D</sub>	@V <sub>GS</sub>
CEP830G	500V	1.5Ω	5A	10V
CEB830G	500V	1.5Ω	5A	10V
CEF830G	500V	1.5Ω	5A <sup>e</sup>	10V

- Super high dense cell design for extremely low R<sub>DS(ON)</sub>.
- High power and current handling capability.
- Lead free product is acquired.

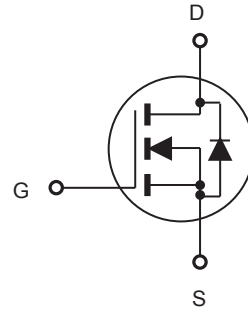
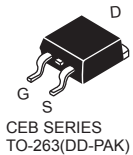

### ABSOLUTE MAXIMUM RATINGS T<sub>C</sub> = 25°C unless otherwise noted

Parameter	Symbol	Limit		Units
		TO-220/263	TO-220F	
Drain-Source Voltage	V <sub>DS</sub>	500		V
Gate-Source Voltage	V <sub>GS</sub>	±30		V
Drain Current-Continuous	I <sub>D</sub>	5	5 <sup>e</sup>	A
Drain Current-Pulsed <sup>a</sup>	I <sub>DM</sub> <sup>f</sup>	20	20 <sup>e</sup>	A
Maximum Power Dissipation @ T <sub>C</sub> = 25°C - Derate above 25°C	P <sub>D</sub>	83	42	W
		0.66	0.33	W/°C
Operating and Store Temperature Range	T <sub>J</sub> , T <sub>stg</sub>	-55 to 150		°C

### Thermal Characteristics

Parameter	Symbol	Limit		Units
Thermal Resistance, Junction-to-Case	R <sub>θJC</sub>	1.5	3.6	°C/W
Thermal Resistance, Junction-to-Ambient	R <sub>θJA</sub>	62.5	65	°C/W

This is preliminary information on a new product in development now .  
Details are subject to change without notice .

Rev 1. 2009.Nov.  
<http://www.cetsemi.com>



# CEP830G/CEB830G CEF830G

## Electrical Characteristics $T_C = 25^\circ\text{C}$ unless otherwise noted

Parameter	Symbol	Test Condition	Min	Typ	Max	Units
<b>Off Characteristics</b>						
Drain-Source Breakdown Voltage	$BV_{DSS}$	$V_{GS} = 0V, I_D = 250\mu A$	500			V
Zero Gate Voltage Drain Current	$I_{DSS}$	$V_{DS} = 500V, V_{GS} = 0V$			1	$\mu A$
Gate Body Leakage Current, Forward	$I_{GSSF}$	$V_{GS} = 30V, V_{DS} = 0V$			100	nA
Gate Body Leakage Current, Reverse	$I_{GSSR}$	$V_{GS} = -30V, V_{DS} = 0V$			-100	nA
<b>On Characteristics<sup>b</sup></b>						
Gate Threshold Voltage	$V_{GS(th)}$	$V_{GS} = V_{DS}, I_D = 250\mu A$	2.5		4	V
Static Drain-Source On-Resistance	$R_{DS(on)}$	$V_{GS} = 10V, I_D = 2.5A$		1.2	1.5	$\Omega$
Forward Transconductance	$g_{FS}$	$V_{DS} = 50V, I_D = 4.8A$		7		S
<b>Dynamic Characteristics<sup>c</sup></b>						
Input Capacitance	$C_{iss}$	$V_{DS} = 25V, V_{GS} = 0V,$ $f = 1.0\text{ MHz}$		595		pF
Output Capacitance	$C_{oss}$			90		pF
Reverse Transfer Capacitance	$C_{rss}$			20		pF
<b>Switching Characteristics<sup>c</sup></b>						
Turn-On Delay Time	$t_{d(on)}$	$V_{DD} = 250V, I_D = 5A,$ $V_{GS} = 10V, R_{GEN} = 14\Omega$		15	30	ns
Turn-On Rise Time	$t_r$			8	16	ns
Turn-Off Delay Time	$t_{d(off)}$			30	60	ns
Turn-Off Fall Time	$t_f$			7	14	ns
Total Gate Charge	$Q_g$	$V_{DS} = 400V, I_D = 5A,$ $V_{GS} = 10V$		13	17	nC
Gate-Source Charge	$Q_{gs}$			2.5		nC
Gate-Drain Charge	$Q_{gd}$			5		nC
<b>Drain-Source Diode Characteristics and Maximum Ratings</b>						
Drain-Source Diode Forward Current	$I_S^f$				5	A
Drain-Source Diode Forward Voltage <sup>b</sup>	$V_{SD}$	$V_{GS} = 0V, I_S = 3.1A$			1.6	V
<b>Notes :</b> □ a.Repetitive Rating : Pulse width limited by maximum junction temperature . b.Pulse Test : Pulse Width $\leq 300\mu s$ , Duty Cycle $\leq 2\%$ . □ c.Guaranteed by design, not subject to production testing. □ d.Limited only by maximum temperature allowed . e.Pulse width limited by safe operating area . f.Full package $I_{S(max)} = 4A$ .						



# CEP830G/CEB830G

## CEF830G

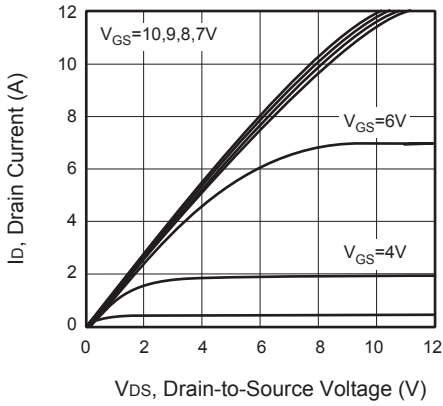

**Figure 1. Output Characteristics**

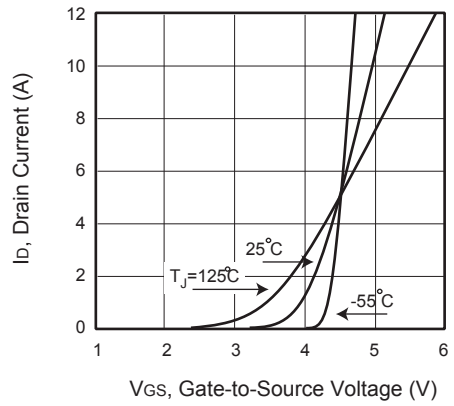

**Figure 2. Transfer Characteristics**

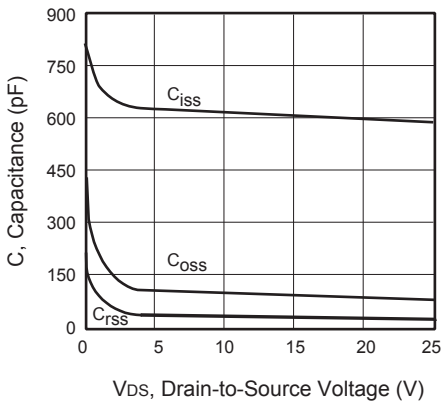

**Figure 3. Capacitance**

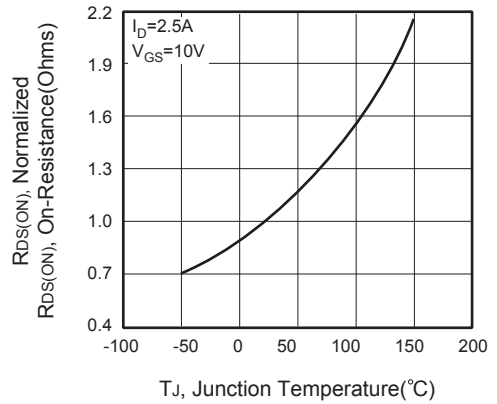

**Figure 4. On-Resistance Variation with Temperature**

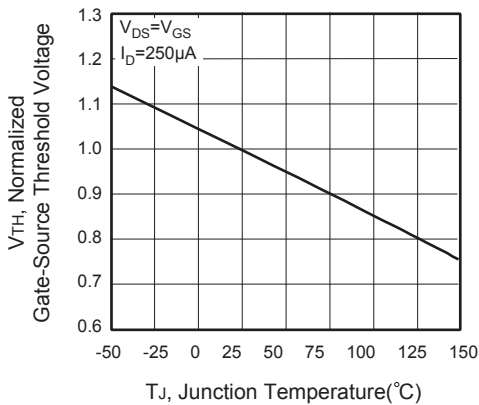

**Figure 5. Gate Threshold Variation with Temperature**

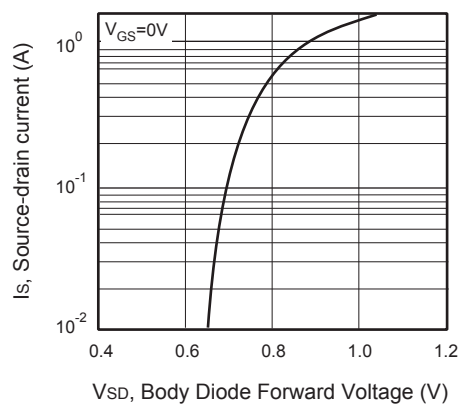

**Figure 6. Body Diode Forward Voltage Variation with Source Current**



# CEP830G/CEB830G

## CEF830G

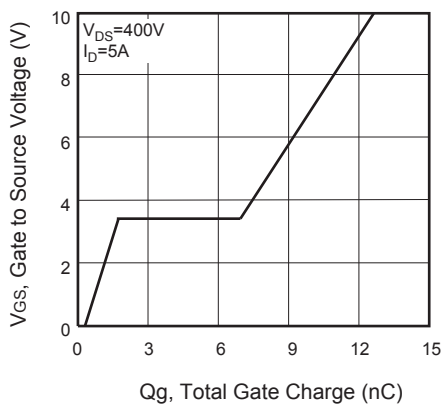

Figure 7. Gate Charge

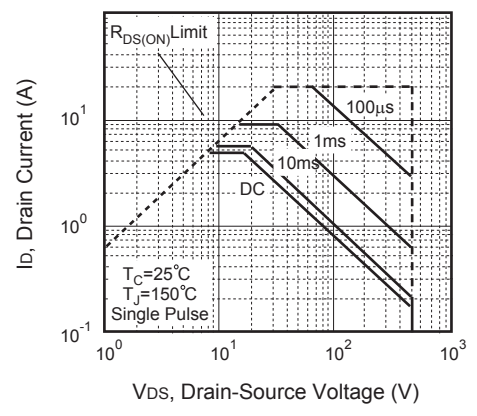

Figure 8. Maximum Safe Operating Area

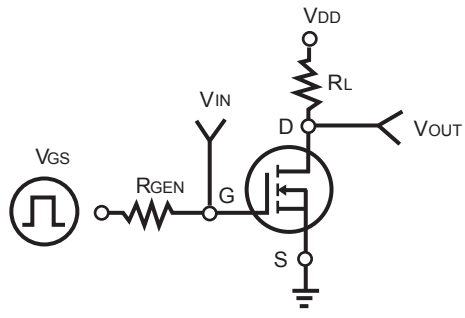

Figure 9. Switching Test Circuit

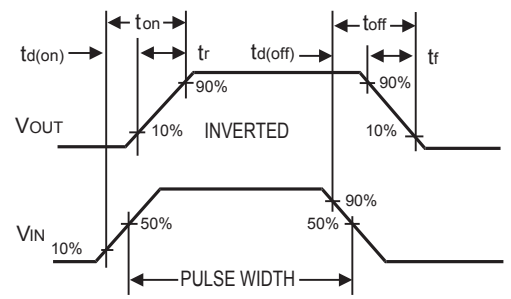

Figure 10. Switching Waveforms

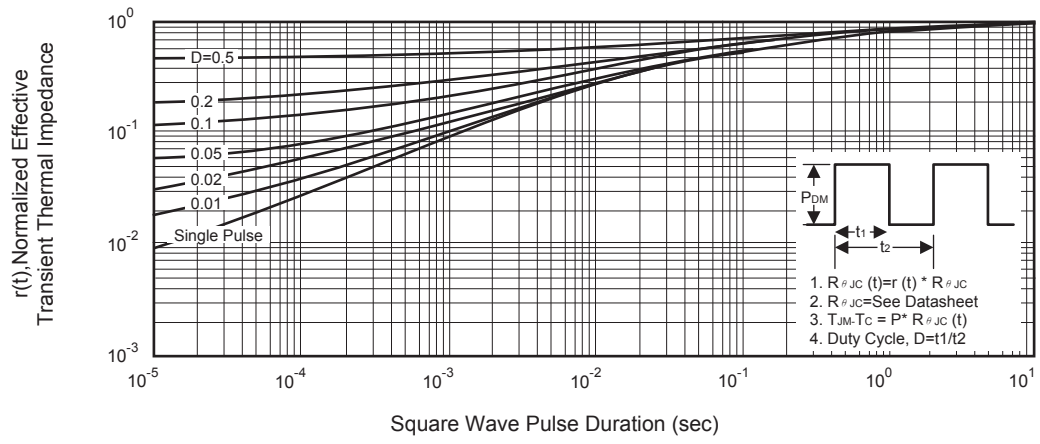

Figure 11. Normalized Thermal Transient Impedance Curve