



CEP45N10/CEB45N10

N-Channel Enhancement Mode Field Effect Transistor

FEATURES

- 100V, 44A, $R_{DS(ON)} = 39m\Omega$ @ $V_{GS} = 10V$.
- Super high dense cell design for extremely low $R_{DS(ON)}$.
- High power and current handling capability.
- Lead free product is acquired.
- TO-220 & TO-263 package.



ABSOLUTE MAXIMUM RATINGS $T_C = 25\text{ C}$ unless otherwise noted

Parameter	Symbol	Limit	Units
Drain-Source Voltage	V_{DS}	100	V
Gate-Source Voltage	V_{GS}	± 25	V
Drain Current-Continuous	I_D	44	A
Drain Current-Pulsed ^a	I_{DM}	176	A
Maximum Power Dissipation @ $T_C = 25^\circ\text{C}$ - Derate above 25°C	P_D	136	W
		0.91	W/ $^\circ\text{C}$
Single Pulsed Avalanche Energy ^d	E_{AS}	397	mJ
Single Pulsed Avalanche Current ^d	I_{AS}	43.5	A
Operating and Store Temperature Range	T_J, T_{stg}	-55 to 175	$^\circ\text{C}$

Thermal Characteristics

Parameter	Symbol	Limit	Units
Thermal Resistance, Junction-to-Case	$R_{\theta JC}$	1.1	$^\circ\text{C/W}$
Thermal Resistance, Junction-to-Ambient	$R_{\theta JA}$	62.5	$^\circ\text{C/W}$



CEP45N10/CEB45N10

Electrical Characteristics $T_C = 25^\circ\text{C}$ unless otherwise noted

Parameter	Symbol	Test Condition	Min	Typ	Max	Units
Off Characteristics						
Drain-Source Breakdown Voltage	BV_{DSS}	$V_{GS} = 0V, I_D = 250\mu A$	100			V
Zero Gate Voltage Drain Current	I_{DSS}	$V_{DS} = 100V, V_{GS} = 0V$			1	μA
Gate Body Leakage Current, Forward	I_{GSSF}	$V_{GS} = 25V, V_{DS} = 0V$			100	nA
Gate Body Leakage Current, Reverse	I_{GSSR}	$V_{GS} = -25V, V_{DS} = 0V$			-100	nA
On Characteristics^b						
Gate Threshold Voltage	$V_{GS(th)}$	$V_{GS} = V_{DS}, I_D = 250\mu A$	2		4	V
Static Drain-Source On-Resistance	$R_{DS(on)}$	$V_{GS} = 10V, I_D = 21.8A$		30	39	m Ω
Dynamic Characteristics^c						
Input Capacitance	C_{iss}	$V_{DS} = 25V, V_{GS} = 0V, f = 1.0\text{ MHz}$		1955		pF
Output Capacitance	C_{oss}			300		pF
Reverse Transfer Capacitance	C_{rss}			35		pF
Switching Characteristics^c						
Turn-On Delay Time	$t_{d(on)}$	$V_{DD} = 50V, I_D = 5A, V_{GS} = 10V, R_{GEN} = 25\Omega$		27	54	ns
Turn-On Rise Time	t_r			19	38	ns
Turn-Off Delay Time	$t_{d(off)}$			185	370	ns
Turn-Off Fall Time	t_f			35	70	ns
Total Gate Charge	Q_g	$V_{DS} = 80V, I_D = 37A, V_{GS} = 10V$		49	65	nC
Gate-Source Charge	Q_{gs}			10		nC
Gate-Drain Charge	Q_{gd}			16		nC
Drain-Source Diode Characteristics and Maximum Ratings						
Drain-Source Diode Forward Current	I_S				44	A
Drain-Source Diode Forward Voltage ^b	V_{SD}	$V_{GS} = 0V, I_S = 40A$			1.5	V
Notes : □ a. Repetitive Rating : Pulse width limited by maximum junction temperature b. Pulse Test : Pulse Width $\leq 300\mu s$, Duty Cycle $\leq 2\%$. □ c. Guaranteed by design, not subject to production testing. □ d. L = 0.42mH, $I_{AS} = 43.5A, V_{DD} = 25V, R_G = 25\Omega$, Starting $T_J = 25\text{ C}$						



CEP45N10/CEB45N10

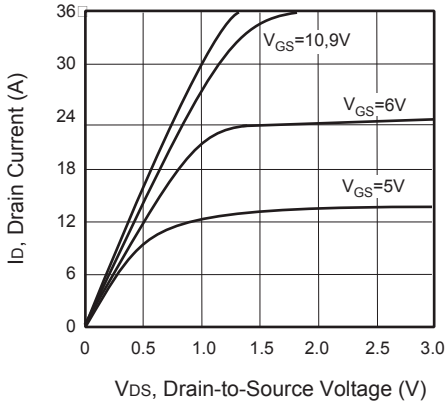

Figure 1. Output Characteristics

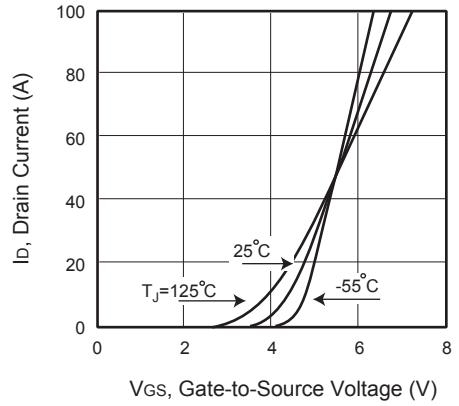

Figure 2. Transfer Characteristics

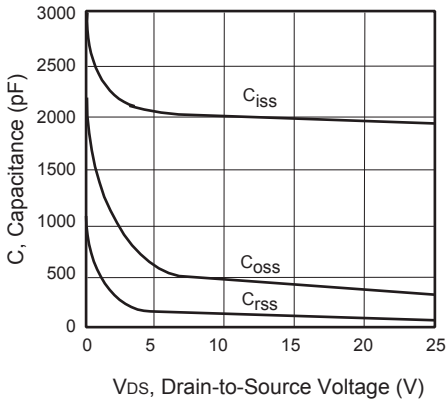

Figure 3. Capacitance

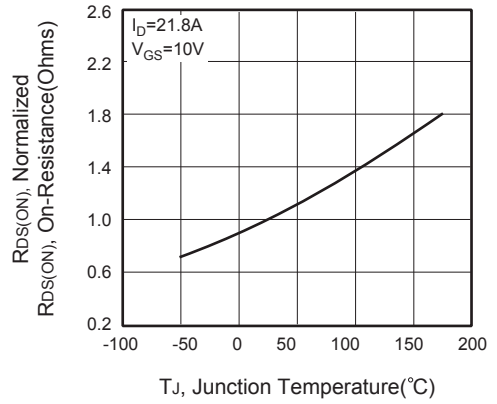

Figure 4. On-Resistance Variation with Temperature

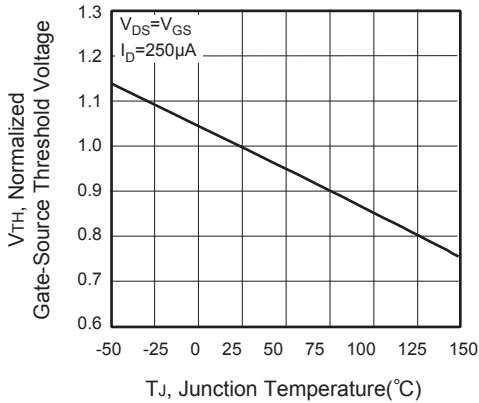

Figure 5. Gate Threshold Variation with Temperature

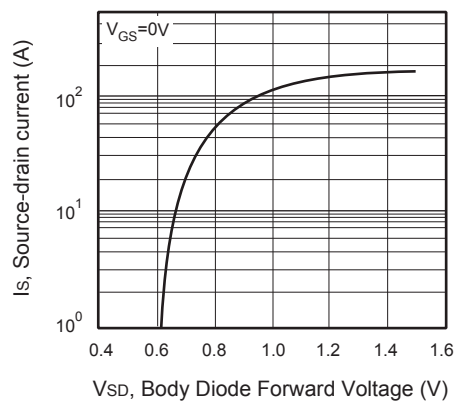

Figure 6. Body Diode Forward Voltage Variation with Source Current



CEP45N10/CEB45N10

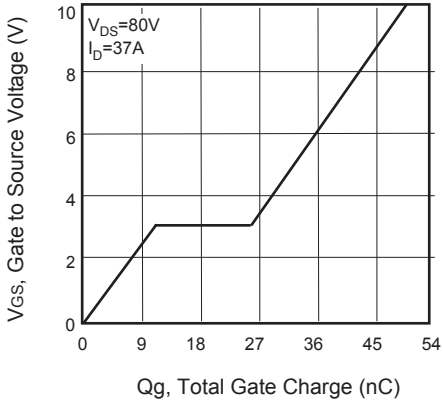

Figure 7. Gate Charge

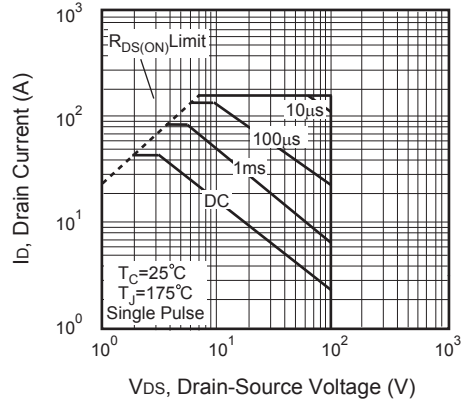

Figure 8. Maximum Safe Operating Area



Figure 9. Switching Test Circuit



Figure 10. Switching Waveforms

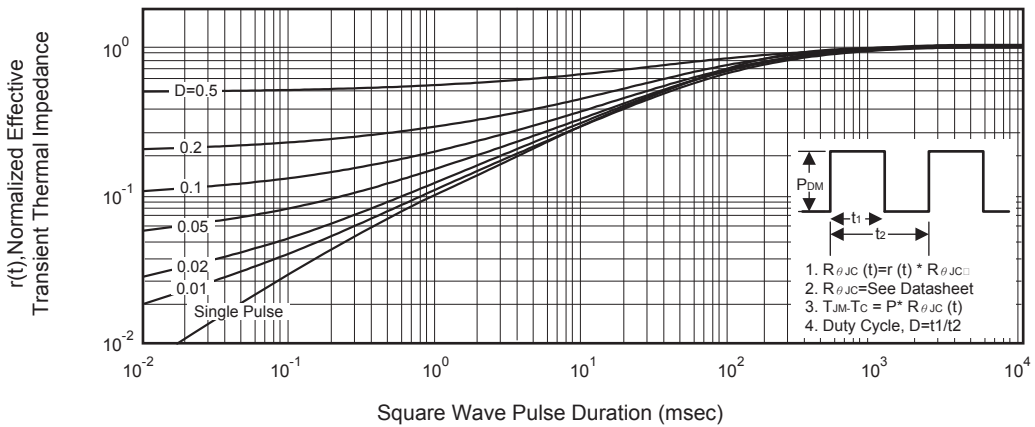

Figure 11. Normalized Thermal Transient Impedance Curve