



CEP15A03/CEB15A03

N-Channel Enhancement Mode Field Effect Transistor

PRELIMINARY

FEATURES

- 30V, 190A, $R_{DS(ON)} = 4.5m\Omega$ @ $V_{GS} = 10V$.
- Super high dense cell design for extremely low $R_{DS(ON)}$.
- High power and current handling capability.
- Lead free product is acquired.
- TO-220 & TO-263 package.

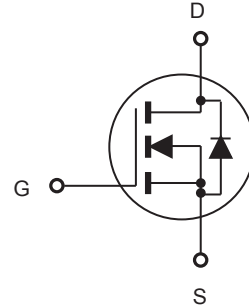

ABSOLUTE MAXIMUM RATINGS $T_C = 25^\circ C$ unless otherwise noted

| Parameter | Symbol | Limit | Units |
|---|----------------|------------|---------------|
| Drain-Source Voltage | V_{DS} | 30 | V |
| Gate-Source Voltage | V_{GS} | ± 20 | V |
| Drain Current-Continuous | I_D | 190 | A |
| Drain Current-Pulsed ^a | I_{DM} | 760 | A |
| Maximum Power Dissipation @ $T_C = 25^\circ C$ - Derate above $25^\circ C$ | P_D | 200 | W |
| | | 1.3 | W/ $^\circ C$ |
| Single Pulsed Avalanche Energy ^d | E_{AS} | 405 | mJ |
| Single Pulsed Avalanche Current ^d | I_{AS} | 52 | A |
| Operating and Store Temperature Range | T_J, T_{stg} | -55 to 175 | $^\circ C$ |

Thermal Characteristics

| Parameter | Symbol | Limit | Units |
|---|-----------------|-------|--------------|
| Thermal Resistance, Junction-to-Case | $R_{\theta JC}$ | 0.75 | $^\circ C/W$ |
| Thermal Resistance, Junction-to-Ambient | $R_{\theta JA}$ | 62.5 | $^\circ C/W$ |

This is preliminary information on a new product in development now .
Details are subject to change without notice .

Rev 2. 2010, June
<http://www.cetsemi.com>



CEP15A03/CEB15A03

Electrical Characteristics $T_C = 25^\circ\text{C}$ unless otherwise noted

| Parameter | Symbol | Test Condition | Min | Typ | Max | Units |
|---|--------------|--|-----|-------|------|-----------|
| Off Characteristics | | | | | | |
| Drain-Source Breakdown Voltage | BV_{DSS} | $V_{GS} = 0V, I_D = 250\mu A$ | 30 | | | V |
| Zero Gate Voltage Drain Current | I_{DSS} | $V_{DS} = 40V, V_{GS} = 0V$ | | | 25 | μA |
| Gate Body Leakage Current, Forward | I_{GSSF} | $V_{GS} = 20V, V_{DS} = 0V$ | | | 100 | nA |
| Gate Body Leakage Current, Reverse | I_{GSSR} | $V_{GS} = -20V, V_{DS} = 0V$ | | | -100 | nA |
| On Characteristics^b | | | | | | |
| Gate Threshold Voltage | $V_{GS(th)}$ | $V_{GS} = V_{DS}, I_D = 250\mu A$ | 2 | | 4 | V |
| Static Drain-Source On-Resistance | $R_{DS(on)}$ | $V_{GS} = 10V, I_D = 70A$ | | 3.8 | 4.5 | $m\Omega$ |
| Forward Transconductance | g_{FS} | $V_{DS} = 25V, I_D = 70A$ | | 30 | | S |
| Dynamic Characteristics^c | | | | | | |
| Input Capacitance | C_{iss} | $V_{DS} = 25V, V_{GS} = 0V, f = 1.0\text{ MHz}$ | | 3350 | | pF |
| Output Capacitance | C_{oss} | | | 1570 | | pF |
| Reverse Transfer Capacitance | C_{rss} | | | 245 | | pF |
| Switching Characteristics^c | | | | | | |
| Turn-On Delay Time | $t_{d(on)}$ | $V_{DD} = 28V, I_D = 10A, V_{GS} = 10V, R_{GEN} = 4.5\Omega$ | | 30 | 60 | ns |
| Turn-On Rise Time | t_r | | | 21 | 42 | ns |
| Turn-Off Delay Time | $t_{d(off)}$ | | | 84 | 168 | ns |
| Turn-Off Fall Time | t_f | | | 39 | 78 | ns |
| Total Gate Charge | Q_g | $V_{DS} = 32V, I_D = 70A, V_{GS} = 10V$ | | 114.7 | 179 | nC |
| Gate-Source Charge | Q_{gs} | | | 14.5 | | nC |
| Gate-Drain Charge | Q_{gd} | | | 47.3 | | nC |
| Drain-Source Diode Characteristics and Maximum Ratings | | | | | | |
| Drain-Source Diode Forward Current | I_S | | | | 190 | A |
| Drain-Source Diode Forward Voltage ^b | V_{SD} | $V_{GS} = 0V, I_S = 70A$ | | | 1.3 | V |
| Notes : □ a.Repetitive Rating : Pulse width limited by maximum junction temperature b.Pulse Test : Pulse Width $\leq 300\mu s$, Duty Cycle $\leq 2\%$. □ c.Guaranteed by design, not subject to production testing. □ d.L = 0.3mH, $I_{AS} = 52A, V_{DD} = 25V, R_G = 25\Omega$, Starting $T_J = 25\text{ C}$ | | | | | | |



CEP15A03/CEB15A03

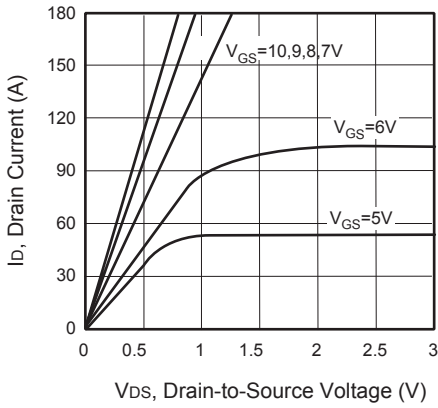

Figure 1. Output Characteristics

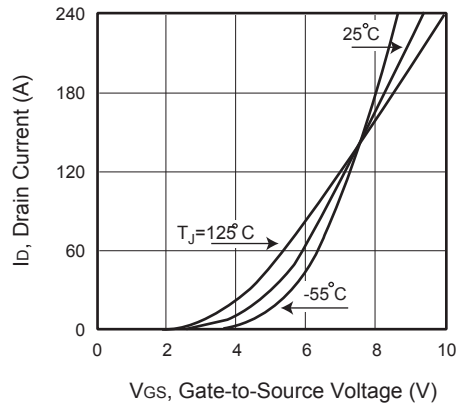

Figure 2. Transfer Characteristics

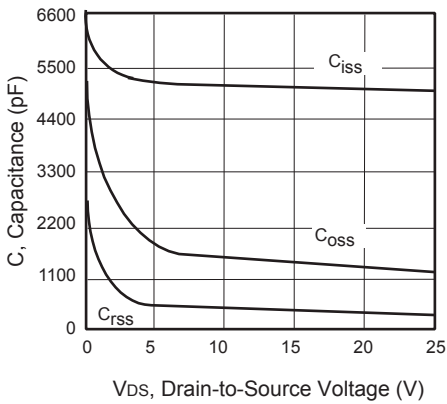

Figure 3. Capacitance

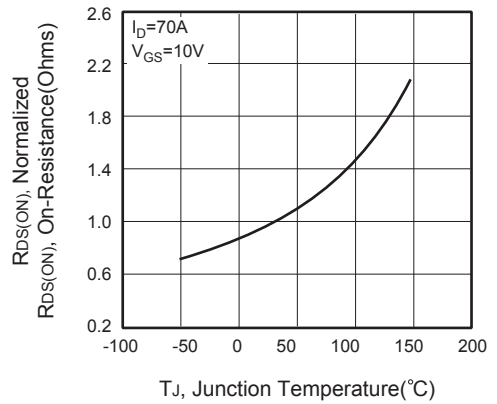

Figure 4. On-Resistance Variation with Temperature

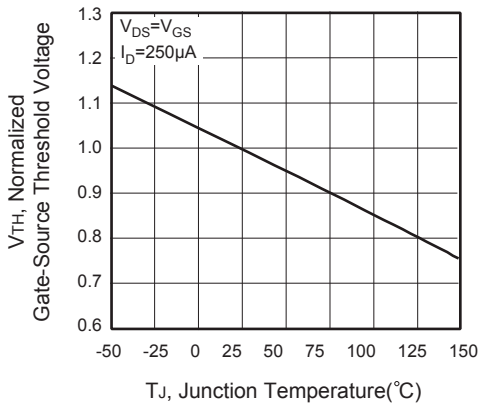

Figure 5. Gate Threshold Variation with Temperature

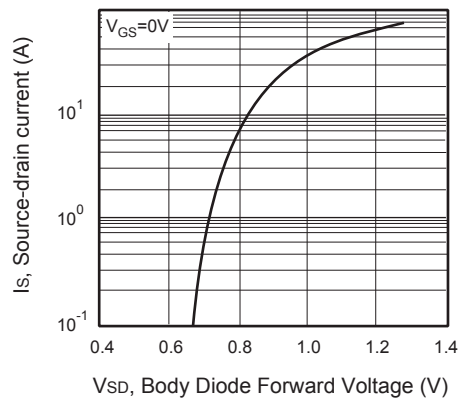

Figure 6. Body Diode Forward Voltage Variation with Source Current



CEP15A03/CEB15A03

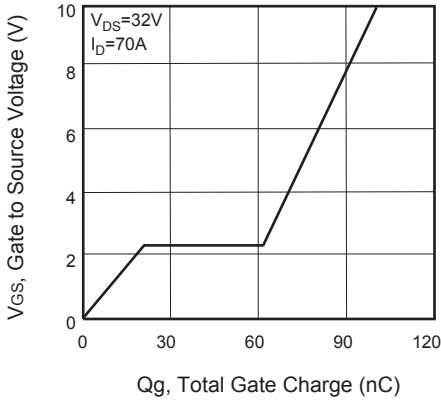

Figure 7. Gate Charge

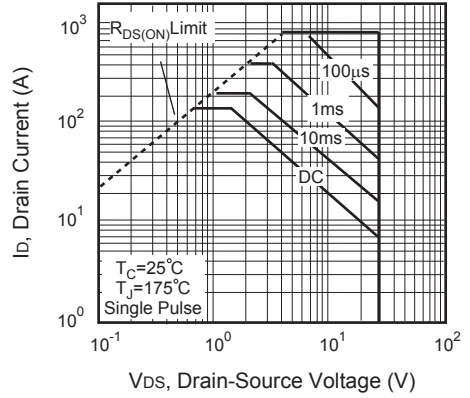

Figure 8. Maximum Safe Operating Area

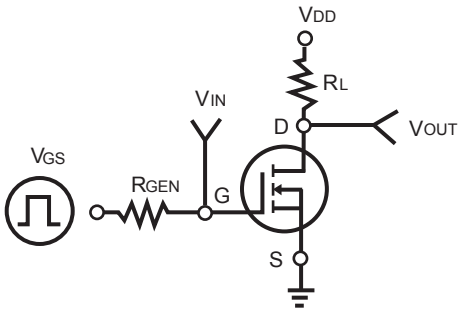

Figure 9. Switching Test Circuit



Figure 10. Switching Waveforms

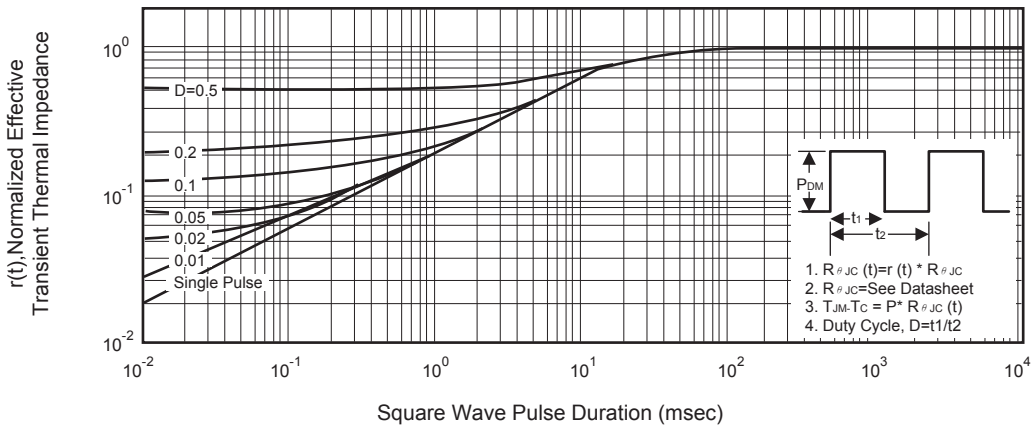

Figure 11. Normalized Thermal Transient Impedance Curve