



# CEP140N10/CEB140N10

## N-Channel Enhancement Mode Field Effect Transistor

### FEATURES

- 100V, 137A,  $R_{DS(ON)} = 7.5m\Omega$  @  $V_{GS} = 10V$ .
- Super high dense cell design for extremely low  $R_{DS(ON)}$ .
- High power and current handling capability.
- Lead-free plating ; RoHS compliant.
- TO-220 & TO-263 package.

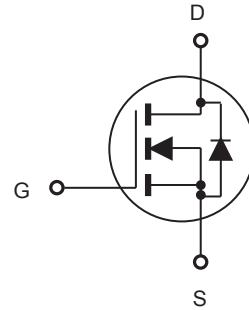

### ABSOLUTE MAXIMUM RATINGS $T_C = 25^\circ C$ unless otherwise noted

Parameter	Symbol	Limit	Units
Drain-Source Voltage	$V_{DS}$	100	V
Gate-Source Voltage	$V_{GS}$	$\pm 20$	V
Drain Current-Continuous @ $T_C = 25^\circ C$	$I_D$	137	A
Drain Current-Continuous @ $T_C = 100^\circ C$		87	A
Drain Current-Pulsed <sup>a</sup>	$I_{DM}$	548	A
Maximum Power Dissipation @ $T_C = 25^\circ C$ - Derate above $25^\circ C$	$P_D$	208	W
		1.7	W/ $^\circ C$
Single Pulsed Avalanche Energy <sup>d</sup>	$E_{AS}$	800	mJ
Single Pulsed Avalanche Current <sup>d</sup>	$I_{AS}$	40	A
Operating and Store Temperature Range	$T_J, T_{stg}$	-55 to 150	$^\circ C$

### Thermal Characteristics

Parameter	Symbol	Limit	Units
Thermal Resistance, Junction-to-Case	$R_{\theta JC}$	0.6	$^\circ C/W$
Thermal Resistance, Junction-to-Ambient	$R_{\theta JA}$	62.5	$^\circ C/W$



# CEP140N10/CEB140N10

## Electrical Characteristics $T_C = 25^\circ\text{C}$ unless otherwise noted

Parameter	Symbol	Test Condition	Min	Typ	Max	Units
<b>Off Characteristics</b>						
Drain-Source Breakdown Voltage	$BV_{DSS}$	$V_{GS} = 0V, I_D = 250\mu A$	100			V
Zero Gate Voltage Drain Current	$I_{DSS}$	$V_{DS} = 100V, V_{GS} = 0V$			1	$\mu A$
Gate Body Leakage Current, Forward	$I_{GSSF}$	$V_{GS} = 20V, V_{DS} = 0V$			100	nA
Gate Body Leakage Current, Reverse	$I_{GSSR}$	$V_{GS} = -20V, V_{DS} = 0V$			-100	nA
<b>On Characteristics<sup>b</sup></b>						
Gate Threshold Voltage	$V_{GS(th)}$	$V_{GS} = V_{DS}, I_D = 250\mu A$	2		4	V
Static Drain-Source On-Resistance	$R_{DS(on)}$	$V_{GS} = 10V, I_D = 35A$		6.1	7.5	$m\Omega$
<b>Dynamic Characteristics<sup>c</sup></b>						
Input Capacitance	$C_{iss}$	$V_{DS} = 25V, V_{GS} = 0V, f = 800KHz$		8715		pF
Output Capacitance	$C_{oss}$			605		pF
Reverse Transfer Capacitance	$C_{rss}$			480		pF
<b>Switching Characteristics<sup>c</sup></b>						
Turn-On Delay Time	$t_{d(on)}$	$V_{DD} = 50V, I_D = 70A, V_{GS} = 10V, R_{GEN} = 2.5\Omega$		44		ns
Turn-On Rise Time	$t_r$			20		ns
Turn-Off Delay Time	$t_{d(off)}$			96		ns
Turn-Off Fall Time	$t_f$			27		ns
Total Gate Charge	$Q_g$	$V_{DS} = 80V, I_D = 70A, V_{GS} = 10V$		227		nC
Gate-Source Charge	$Q_{gs}$			62		nC
Gate-Drain Charge	$Q_{gd}$			69		nC
<b>Drain-Source Diode Characteristics and Maximum Ratings</b>						
Drain-Source Diode Forward Current	$I_S$				137	A
Drain-Source Diode Forward Voltage <sup>b</sup>	$V_{SD}$	$V_{GS} = 0V, I_S = 35A$			1.5	V
<b>Notes :</b> □ a.Repetitive Rating : Pulse width limited by maximum junction temperature b.Pulse Test : Pulse Width $\leq 300\mu s$ , Duty Cycle $\leq 2\%$ . □ c.Guaranteed by design, not subject to production testing. □ d.L = 1mH, $I_{AS} = 40A, V_{DD} = 25V, R_G = 25\Omega$ , Starting $T_J = 25^\circ C$ . □						



# CEP140N10/CEB140N10

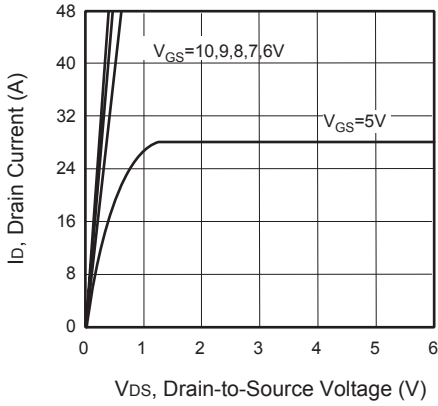

Figure 1. Output Characteristics

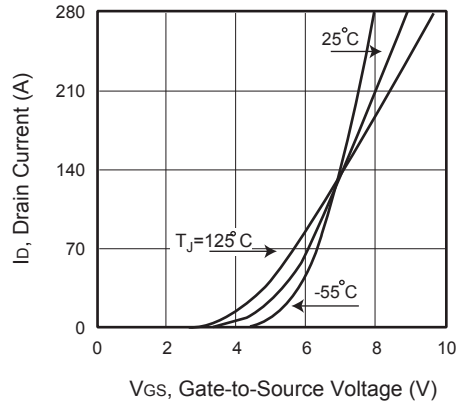

Figure 2. Transfer Characteristics

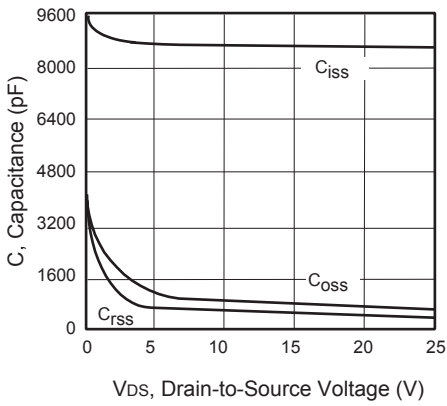

Figure 3. Capacitance

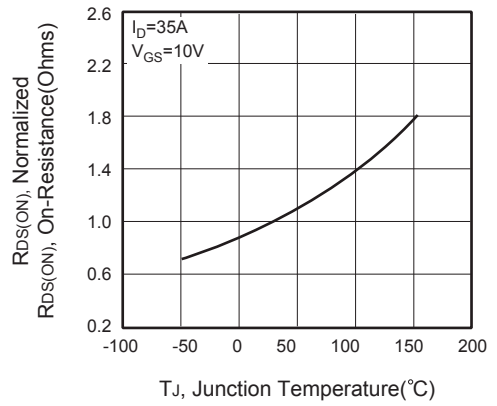

Figure 4. On-Resistance Variation with Temperature

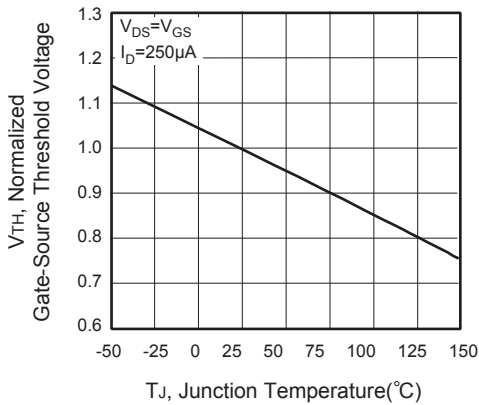

Figure 5. Gate Threshold Variation with Temperature

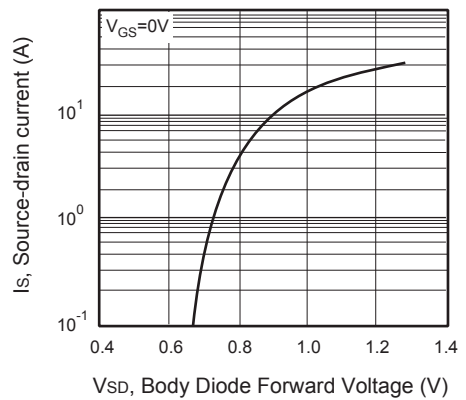

Figure 6. Body Diode Forward Voltage Variation with Source Current



# CEP140N10/CEB140N10

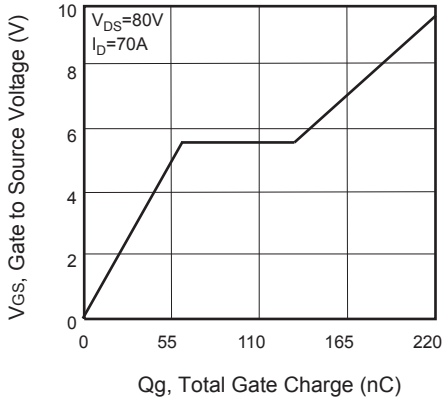

Figure 7. Gate Charge

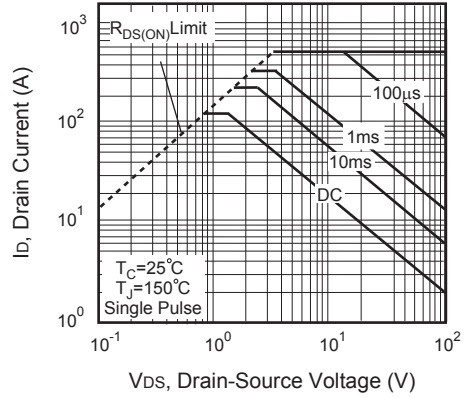

Figure 8. Maximum Safe Operating Area

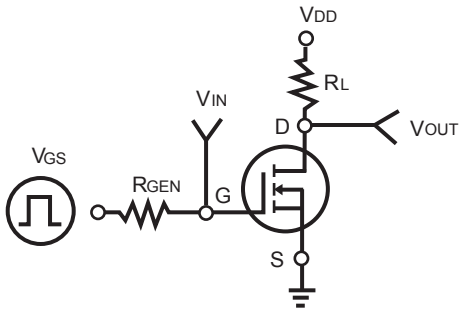

Figure 9. Switching Test Circuit

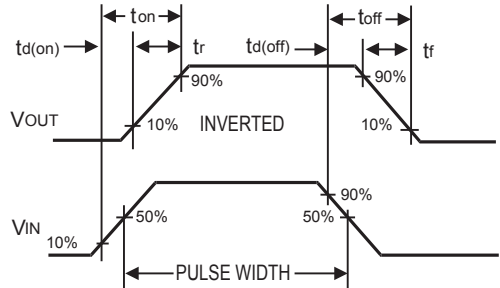

Figure 10. Switching Waveforms

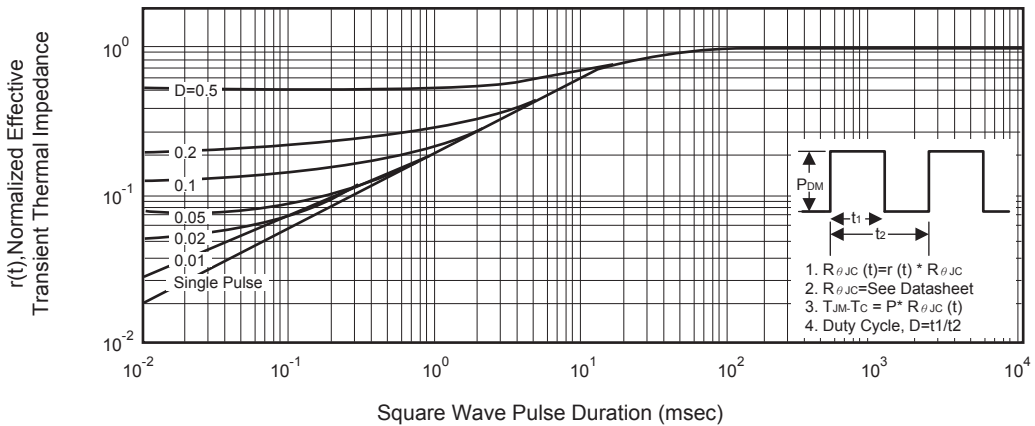

Figure 11. Normalized Thermal Transient Impedance Curve