



CEP1195/CEB1195

CEF1195

N-Channel Enhancement Mode Field Effect Transistor

FEATURES

Type	V _{DSS}	R _{DS(ON)}	I _D	@V _{GS}
CEP1195	900V	2.75Ω	5A	10V
CEB1195	900V	2.75Ω	5A	10V
CEF1195	900V	2.75Ω	5A ^d	10V

- Super high dense cell design for extremely low R_{DS(ON)}.
- High power and current handling capability.
- Lead free product is acquired.

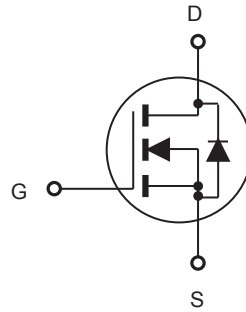

ABSOLUTE MAXIMUM RATINGS $T_C = 25^\circ\text{C}$ unless otherwise noted

Parameter	Symbol	Limit		Units
		TO-220/263	TO-220F	
Drain-Source Voltage	V _{DS}	900		V
Gate-Source Voltage	V _{GS}	±30		V
Drain Current-Continuous	I _D	5	5 ^d	A
Drain Current-Pulsed ^a	I _{DM} ^e	20	20 ^d	A
Maximum Power Dissipation @ T _C = 25°C - Derate above 25°C	P _D	166	50	W
		1.3	0.4	W/°C
Operating and Store Temperature Range	T _J , T _{stg}	-55 to 150		°C

Thermal Characteristics

Parameter	Symbol	Limit		Units
Thermal Resistance, Junction-to-Case	R _{θJC}	0.75	2.5	°C/W
Thermal Resistance, Junction-to-Ambient	R _{θJA}	62.5	65	°C/W



CEP1195/CEB1195

CEF1195

Electrical Characteristics $T_C = 25^\circ\text{C}$ unless otherwise noted

Parameter	Symbol	Test Condition	Min	Typ	Max	Units
Off Characteristics						
Drain-Source Breakdown Voltage	BV_{DSS}	$V_{GS} = 0V, I_D = 250\mu A$	900			V
Zero Gate Voltage Drain Current	I_{DSS}	$V_{DS} = 810V, V_{GS} = 0V$			10	μA
Gate Body Leakage Current, Forward	I_{GSSF}	$V_{GS} = 30V, V_{DS} = 0V$			100	nA
Gate Body Leakage Current, Reverse	I_{GSSR}	$V_{GS} = -30V, V_{DS} = 0V$			-100	nA
On Characteristics ^b						
Gate Threshold Voltage	$V_{GS(th)}$	$V_{GS} = V_{DS}, I_D = 250\mu A$	2		4	V
Static Drain-Source On-Resistance	$R_{DS(on)}$	$V_{GS} = 10V, I_D = 2.5A$		2.35	2.75	Ω
Dynamic Characteristics ^c						
Input Capacitance	C_{iss}	$V_{DS} = 25V, V_{GS} = 0V,$ $f = 1.0 \text{ MHz}$		1440		pF
Output Capacitance	C_{oss}			130		pF
Reverse Transfer Capacitance	C_{rss}			10		pF
Switching Characteristics ^c						
Turn-On Delay Time	$t_{d(on)}$	$V_{DD} = 300V, I_D = 5A,$ $V_{GS} = 10V, R_{GEN} = 25\Omega$		30	60	ns
Turn-On Rise Time	t_r			21.5	43	ns
Turn-Off Delay Time	$t_{d(off)}$			80	160	ns
Turn-Off Fall Time	t_f			22	44	ns
Total Gate Charge	Q_g	$V_{DS} = 480V, I_D = 5A,$ $V_{GS} = 10V$		30	39	nC
Gate-Source Charge	Q_{gs}			6		nC
Gate-Drain Charge	Q_{gd}			10		nC
Drain-Source Diode Characteristics and Maximum Ratings						
Drain-Source Diode Forward Current	I_S^f				5	A
Drain-Source Diode Forward Voltage ^b	V_{SD}^g	$V_{GS} = 0V, I_S = 5A$			1.4	V
Notes : <input type="checkbox"/> a.Repetitive Rating : Pulse width limited by maximum junction temperature . b.Pulse Test : Pulse Width $\leq 300\mu s$, Duty Cycle $\leq 2\%$. <input type="checkbox"/> c.Guaranteed by design, not subject to production testing. <input type="checkbox"/> d.Limited only by maximum temperature allowed . e.Pulse width limited by safe operating area . f.Full package $I_{S(max)} = 3.2A$. g.Full package V_{SD} test condition $I_S = 3.2A$.						



CEP1195/CEB1195

CEF1195

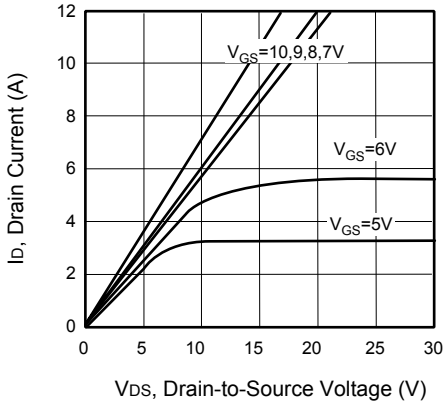

Figure 1. Output Characteristics

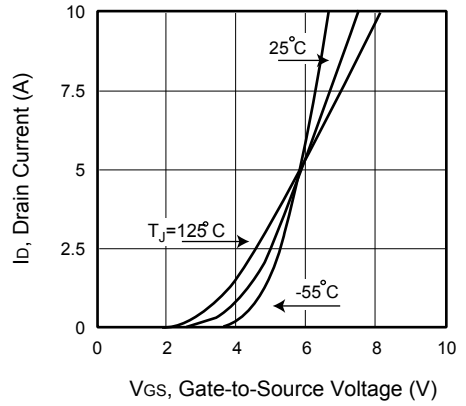

Figure 2. Transfer Characteristics

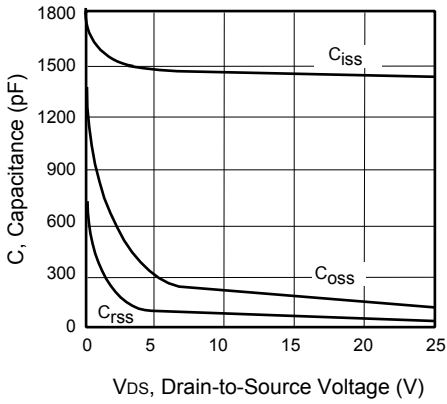

Figure 3. Capacitance

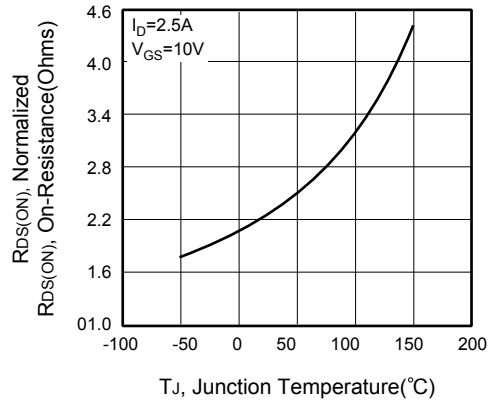

Figure 4. On-Resistance Variation with Temperature

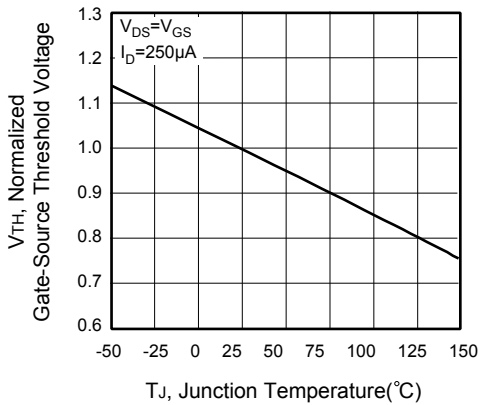

Figure 5. Gate Threshold Variation with Temperature

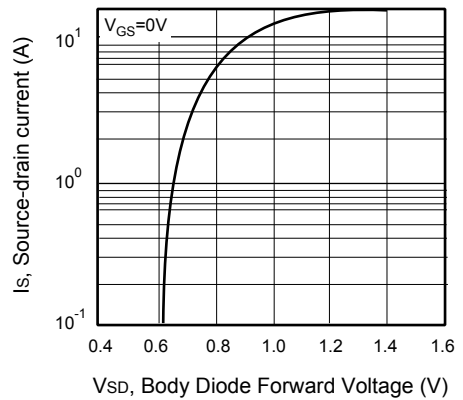

Figure 6. Body Diode Forward Voltage Variation with Source Current



CEP1195/CEB1195 CEF1195

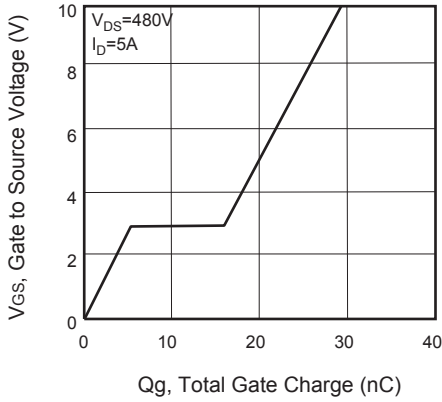

Figure 7. Gate Charge

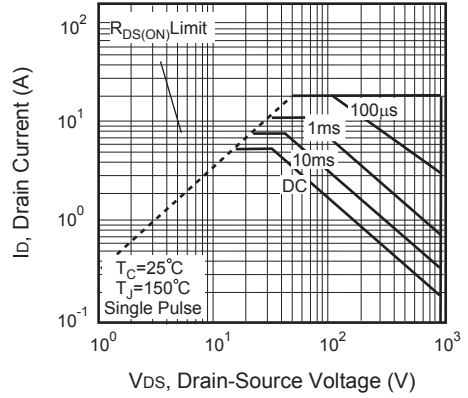

Figure 8. Maximum Safe Operating Area

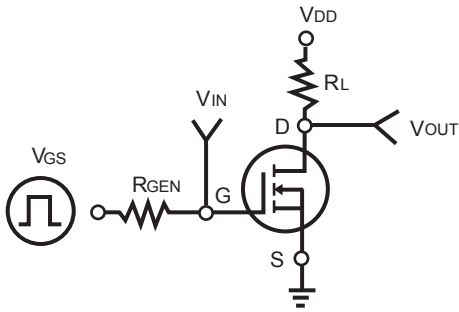

Figure 9. Switching Test Circuit

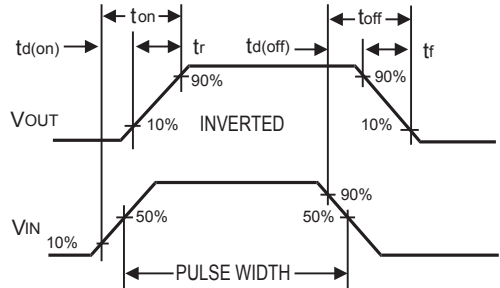

Figure 10. Switching Waveforms

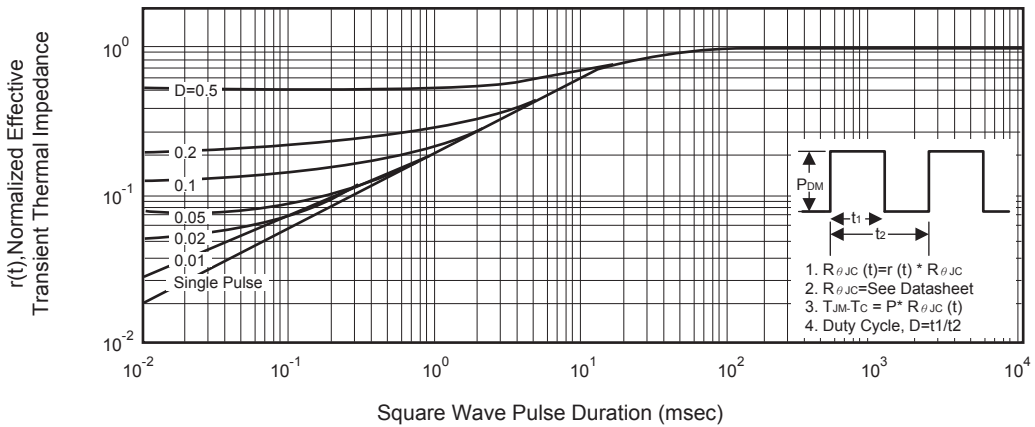

Figure 11. Normalized Thermal Transient Impedance Curve