



SSF2318E

20V N-Channel MOSFET

DESCRIPTION

The SSF2318E uses advanced trench technology to provide excellent $R_{DS(ON)}$, low gate charge and operation with gate voltages as low as 2.5V.

GENERAL FEATURES

- $V_{DS} = 20V, I_D = 6.5A$
 $R_{DS(ON)} < 34m\Omega @ V_{GS}=1.8V$
 $R_{DS(ON)} < 26m\Omega @ V_{GS}=2.5V$
 $R_{DS(ON)} < 22m\Omega @ V_{GS}=4.5V$

ESD Rating: 2000V HBM

- High Power and current handing capability
- Lead free product
- Surface Mount Package

APPLICATIONS

- Battery protection
- Load switch
- Power management

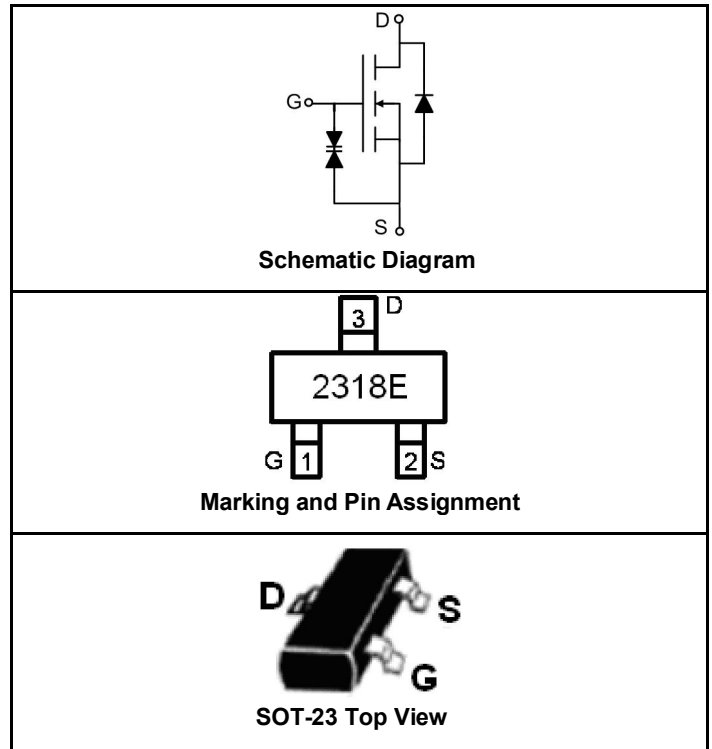

PACKAGE MARKING AND ORDERING INFORMATION

Device Marking	Device	Device Package	Reel Size	Tape Width	Quantity
2318E	SSF2318E	SOT-23	Ø330mm	12mm	3000 units

ABSOLUTE MAXIMUM RATINGS ($T_A=25^\circ C$ unless otherwise noted)

Parameter	Symbol	Limit	Unit
Drain-Source Voltage	V_{DS}	20	V
Gate-Source Voltage	V_{GS}	±8	V
Drain Current-Continuous@ Current-Pulsed (Note 1)	I_D	6.5	A
	I_{DM}	30	A
Maximum Power Dissipation	P_D	1.4	W
Operating Junction and Storage Temperature Range	T_J, T_{STG}	-55 To 150	°C

THERMAL CHARACTERISTICS

Thermal Resistance, Junction-to-Ambient (Note 2)	$R_{\theta JA}$	90	°C/W
--	-----------------	----	------



SSF2318E

20V N-Channel MOSFET

ELECTRICAL CHARACTERISTICS (T_A=25°C unless otherwise noted)

Parameter	Symbol	Condition	Min	Typ	Max	Unit
OFF CHARACTERISTICS						
Drain-Source Breakdown Voltage	BV _{DSS}	V _{GS} =0V, I _D =250μA	20			V
Zero Gate Voltage Drain Current	I _{DSS}	V _{DS} =20V, V _{GS} =0V			1	μA
Gate-Body Leakage Current	I _{GSS}	V _{GS} =±4.5V, V _{DS} =0V			±1	uA
		V _{GS} =±8V, V _{DS} =0V			±10	uA
ON CHARACTERISTICS (Note 3)						
Gate Threshold Voltage	V _{GS(th)}	V _{DS} =V _{GS} , I _D =250μA	0.4	0.6	1	V
Drain-Source On-State Resistance	R _{DS(on)}	V _{GS} =4.5V, I _D =6.5A		18	22	mΩ
		V _{GS} =2.5V, I _D =5.5A		21	26	mΩ
		V _{GS} =1.8V, I _D =5A		26	34	mΩ
Forward Transconductance	g _{FS}	V _{DS} =5V, I _D =6.5A		7		S
DYNAMIC CHARACTERISTICS (Note4)						
Input Capacitance	C _{iss}	V _{DS} =10V, V _{GS} =0V, F=1.0MHz		1160		PF
Output Capacitance	C _{oss}			200		PF
Reverse Transfer Capacitance	C _{rss}			140		PF
SWITCHING CHARACTERISTICS (Note 4)						
Turn-on Delay Time	t _{d(on)}	V _{DD} =10V, I _D =1A V _{GS} =5V, R _{GEN} =3Ω		6.5		nS
Turn-on Rise Time	t _r			13		nS
Turn-Off Delay Time	t _{d(off)}			50		nS
Turn-Off Fall Time	t _f			30		nS
Total Gate Charge	Q _g	V _{DS} =10V, I _D =6.5A, V _{GS} =4.5V		10		nC
Gate-Source Charge	Q _{gs}			2.3		nC
Gate-Drain Charge	Q _{gd}			3		nC
DRAIN-SOURCE DIODE CHARACTERISTICS						
Diode Forward Voltage (Note 3)	V _{SD}	V _{GS} =0V, I _S =1A		0.76	1	V

NOTES:

1. Repetitive Rating: Pulse width limited by maximum junction temperature.
2. Surface Mounted on FR4 Board, t ≤ 10 sec.
3. Pulse Test: Pulse Width ≤ 300μs, Duty Cycle ≤ 2%.
4. Guaranteed by design, not subject to production testing.

TYPICAL ELECTRICAL AND THERMAL CHARACTERISTICS

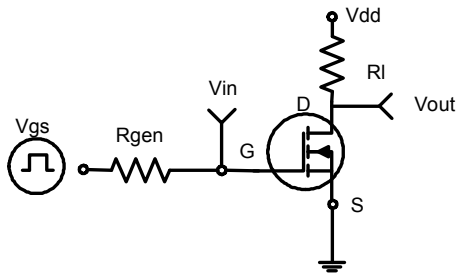

Figure 1: Switching Test Circuit

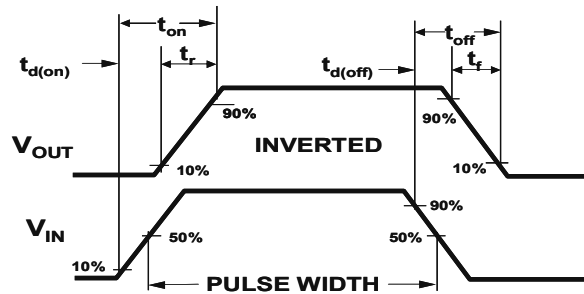

Figure 2: Switching Waveforms

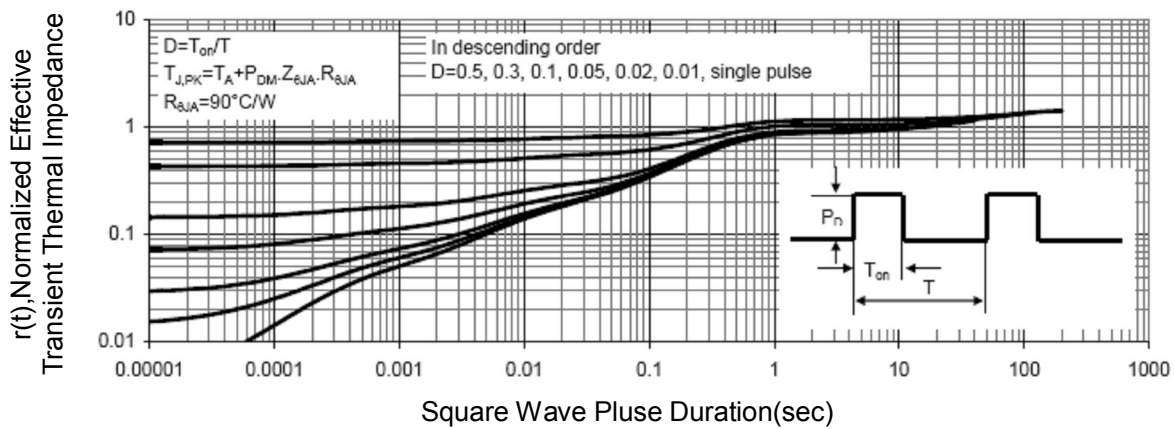
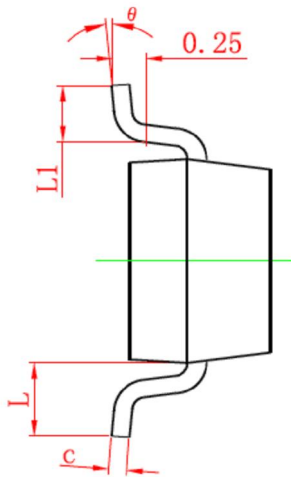
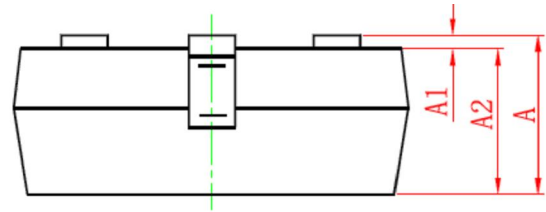
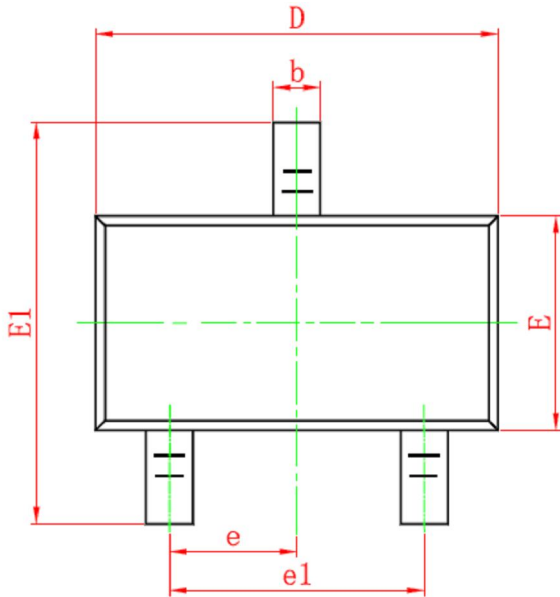

Figure 3 Normalized Maximum Transient Thermal Impedance

SOT-23 PACKAGE INFORMATION

Dimensions in Millimeters (UNIT: mm)



Symbol	Dimensions in Millimeters	
	MIN.	MAX.
A	0.900	1.150
A1	0.000	0.100
A2	0.900	1.050
b	0.300	0.500
c	0.080	0.150
D	2.800	3.000
E	1.200	1.400
E1	2.250	2.550
e	0.950TYP	
e1	1.800	2.000
L	0.550REF	
L1	0.300	0.500
θ	0°	8°

NOTES

- All dimensions are in millimeters.
- Tolerance $\pm 0.10\text{mm}$ (4 mil) unless otherwise specified
- Package body sizes exclude mold flash and gate burrs. Mold flash at the non-lead sides should be less than 5 mils.
- Dimension L is measured in gauge plane.
- Controlling dimension is millimeter, converted inch dimensions are not necessarily exact