



KBJL4JU-C THRU KBJL4MU-C

Glass Passivated Single-Phase Bridge Rectifier
Reverse Voltage - 600V to 1000V
Forward Current - 4.0 Amperes

Features

- ◆ Thin Single In-Line package;
- ◆ Ideal for printed circuit boards;
- ◆ Glass Passivated chip junction;
- ◆ Low profile package;
- ◆ High Surge current capability;
- ◆ High case dielectric strength of 2000 V_{RMS};
- ◆ Plastic package has Underwrites Laboratory Flammability Classification 94V-0;
- ◆ Same footprint V.S KBJ (3S) package;

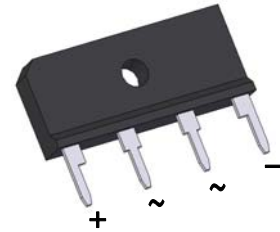
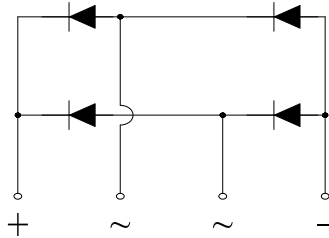

Mechanical Data

- ◆ Case: KBJL;
Epoxy meets UL-94V-0 Flammability rating;
- ◆ Terminals: Matte tin plated leads, solderable per J-STD-002 and JESD22-B102; E3 suffix for customer grade, meet JESD 201 class 1A whisker test;
- ◆ High temperature soldering guaranteed:
Solder Dip 275°C, 40seconds;
- ◆ Polarity: As marked on body;
- ◆ Mounting Torque: 5.7cm·kg (5.0 inches·lbs) max;
- ◆ Recommend Torque: Mounting Torque:
5.7cm·kg (5 inches·lbs);

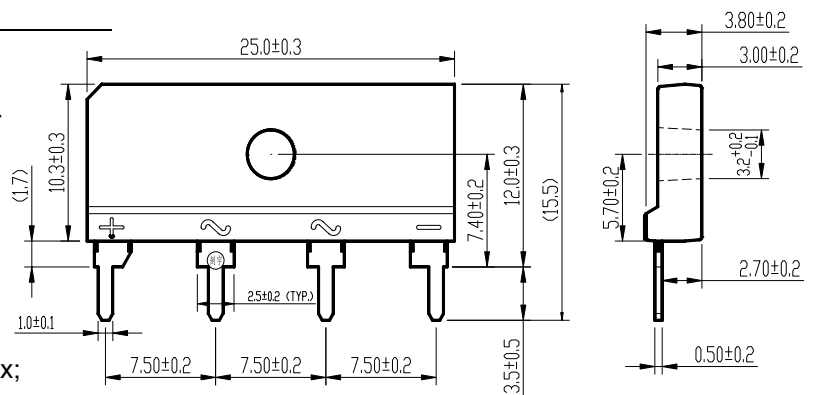

Package Dimensions in mm

Typical Applications

General purpose use in AC-to-DC bridge full wave rectification for Switching Power Supply, Home Appliances, Office Equipment, Industrial Automation applications.

Maximum Ratings and Electrical Characteristics

Ratings at 25°C ambient temperature unless otherwise specified.

Parameter	Symbol	KBJL4JU-C	KBJL4KU-C	KBJL4MU-C	Unit
Maximum repetitive peak reverse voltage	V _{RRM}	600	800	1000	V
Maximum RMS voltage	V _{RMS}	420	560	700	V
Maximum DC blocking voltage	V _{DC}	600	800	1000	V
Maximum average forward rectified output current at T _C =110°C T _A =25°C	I _{F(AV)}	4.0 ⁽¹⁾ 2.4 ⁽²⁾			Amps
Peak forward surge current 8.3 ms single sine-wave superimposed on rated load (JEDEC Method)	I _{FSM}	120			Amps
Rating for fusing (t<8.3ms)	I ² t	60			A ² sec
Maximum Instantaneous forward voltage drop per leg at 2.0A	V _F	0.96			Volt
Maximum DC Reverse Current at Rated DC Blocking Voltage per leg T _A =25°C T _A =125°C	I _R	5 150			μA
Typical thermal resistance per leg	R _{θJA} R _{θJC}	26 ⁽²⁾ 2.2 ⁽¹⁾			°C/W
Operating junction and Storage Temperature Range	T _J , T _{STG}	-55 to +150			°C

Notes:

- 1). Unit case mounted on Al plate heatsink;
- 2). Units mounted on PCB without heatsink;
- 3). Recommended mounting position is to bolt down on heatsink with silicone thermal compound for maximum heat transfer with #6 screw.



KBJL4JU-C THRU KBJL4MU-C
Glass Passivated Single-Phase Bridge Rectifier
Reverse Voltage - 600V to 1000V
Forward Current - 4.0 Amperes

RATINGS AND CHARACTERISTICS CURVES

($T_A=25^\circ\text{C}$ unless otherwise noted)

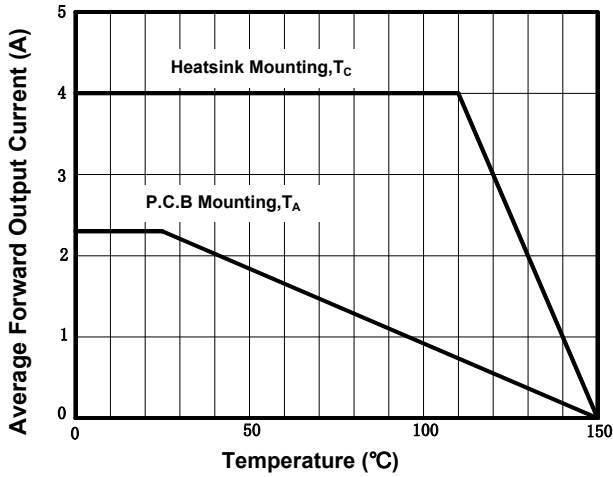

Figure 1. Derating Curve Output Rectified Current

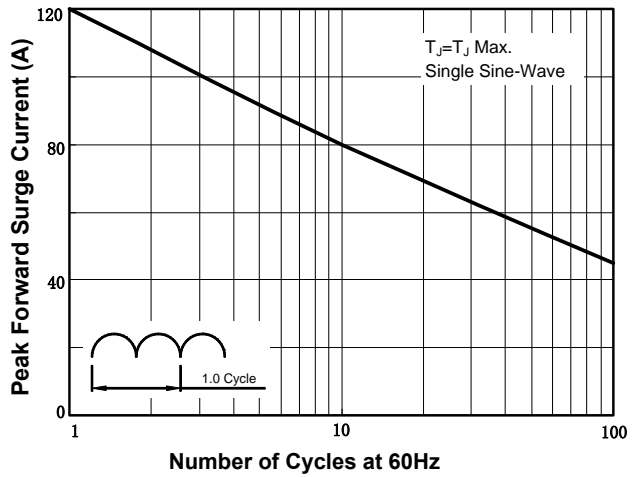

Figure 2. Maximum Non-Repetitive Peak Forward Surge Current per Diode

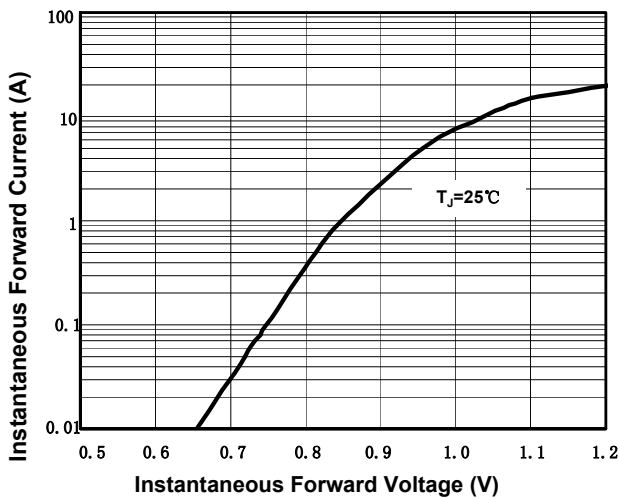

Figure 3. Typical Forward Characteristics Per Diode

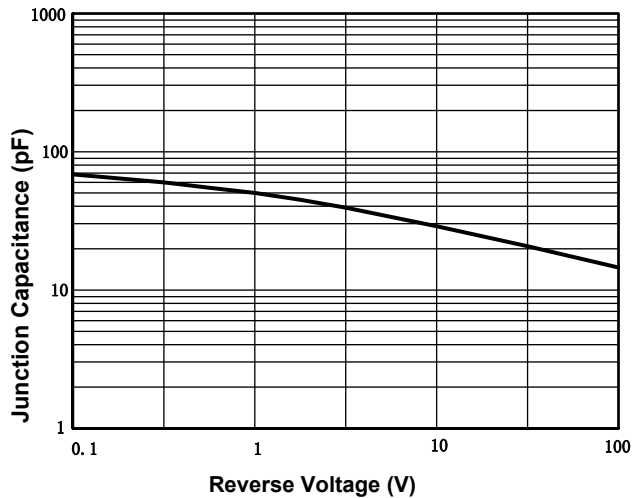

Figure 4. Typical Junction Capacitance Per Diode

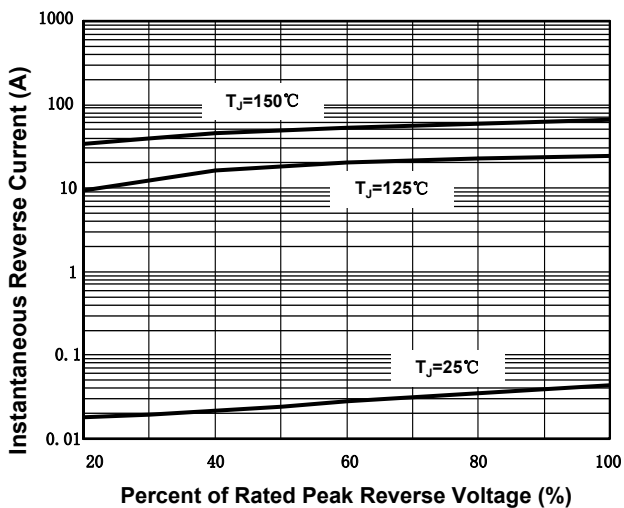

Figure 5. Typical Reverse Characteristics Per Diode