

## Product Specification

GOODARK Type

**MUR1060F -S(Short lead)**

Construction : Ultra Fast Recover diode

Application : For power switch

(Manufacturer) :

Suzhou Goodark Electronics Co.,Ltd

Prepared on Sep. 17<sup>th</sup>, 2008

Prepared: R & D Department

Approval:

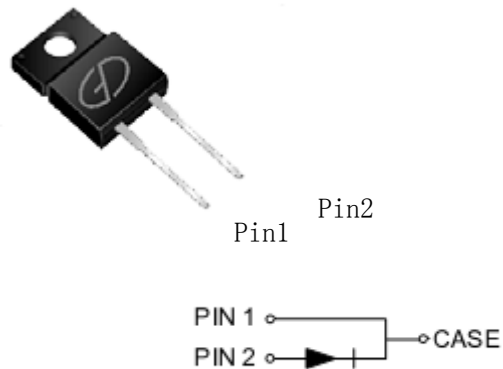

### CONTENTS

1. Package Outline
2. Marking
3. Features& Mechanical Characteristics
4. Maximum Ratings and Electrical Characteristics
5. Rating and characteristic Curves
6. Packing Specification PACKAGING SPECIFICATION
7. Description of Box Label

### 1. Package Outline (TO220F(Short Lead))

UNIT:mm

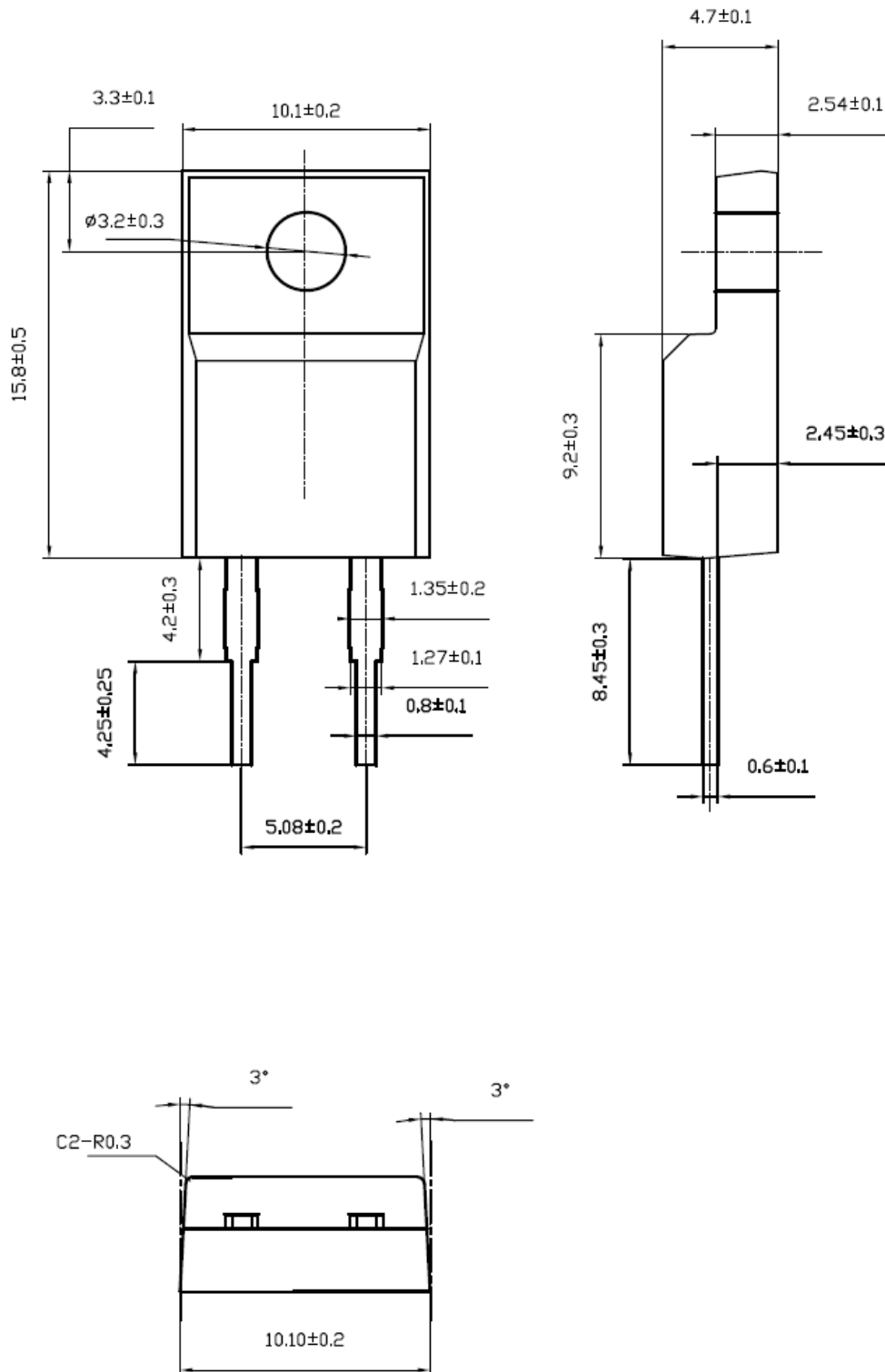

Lead Frame Material : Copper    Plating: Pure Tin Plating

## 2. MARKING

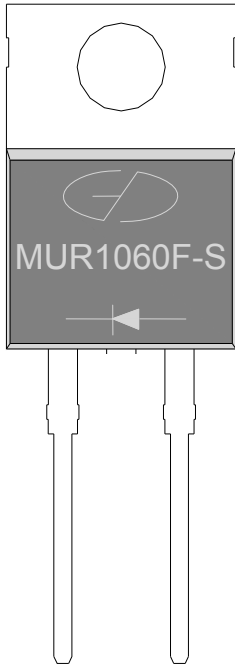

1. Part Name : MUR1060F-S

2. Logo Mark: 

3. Polarity: 



### 3. Features & Mechanical Characteristics

#### Features

- Plastic package has underwriters Laboratory Flammability Classification 94V-0
- Dual rectifier construction, positive center tap
- Metal of silicon rectifier, majority carrier conduction
- Low forward voltage, high efficiency
- Guarding for over voltage protection
- For use in low voltage, high frequency inverters,
- Free wheeling, and polarity protection applications

#### Mechanical Characteristics

- Case: Epoxy, Molded
- Weight: 1.9grams (approximately)
- Finish: All External Surfaces Corrosion Resistant and Terminal Leads are Readily Solderable
- Lead Temperature for Soldering Purposes: 260°C Max.for10 sec
- Shipped 50 units per plastic tube

### 4. Maximum Ratings and Electrical Characteristics

MAXIMUM RATINGS and ELECTRICAL CHARACTERISTICS(TC=25°C unless otherwise moted)					
PARAMETER	TEST CONDITIONS		SYMBOL	MUR1060F-S	UNIT
Maximum repetitive peak reverse voltage			VRRM	600	V
Working peak reverse voltage			VRWM	600	V
Maximum DC blocking voltage			VDC	600	V
Maximum average forward rectified current at Tc=105°C total device per diode			IF(AV)	10	A
Peak forward surge current 8.3ms single half sine-wave superimposed on rated load per diode			IFSM	125	A
Operating junction temperature range			TJ	-55 to+150	°C
Isolation voltage (TO220F only) from terminal to heatsink t = 1 Min			VAC	1500	V
Storage temperature range			TSTG	-55 to+150	°C
Maximum instantaneous forward voltage per leg	IF=10A IF=10A	TC=25°C TC=125°C	VF	1.60 1.25	V
Maximum reverse current per leg at working peak Reverse voltage			IR	10 500	uA uA
Maximum Reverse Recover Time (If=0.5Amp, IR=1.0Amp,Irec=0.25Amp)	Trr		Trr	50	ns

#### Thermal Characteristics Ta=25°C unless otherwise noted

Symbol	Parameter	Max (TO220F)	Unit
RθJC	Thermal Resistance, Junction to Case per Leg	4.0	°C /W
RθJA	Thermal Resistance, Junction to Ambient per Leg	62.5	°C /W

#### Note:

1. Screw mounting with 4-40 screw, where washer diameter is ≤4.9mm(0.19 ")
2. Pulse test:300us pulse width,1% duty cycle



### 5. Rating and Characteristic Curves

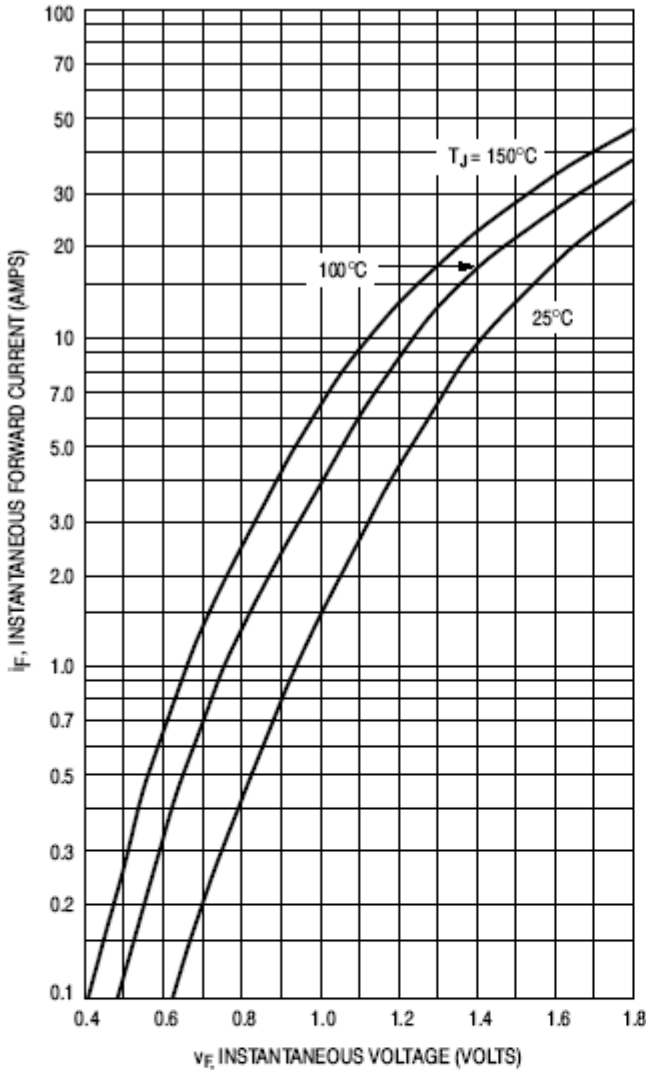

Figure 11. Typical Forward Voltage

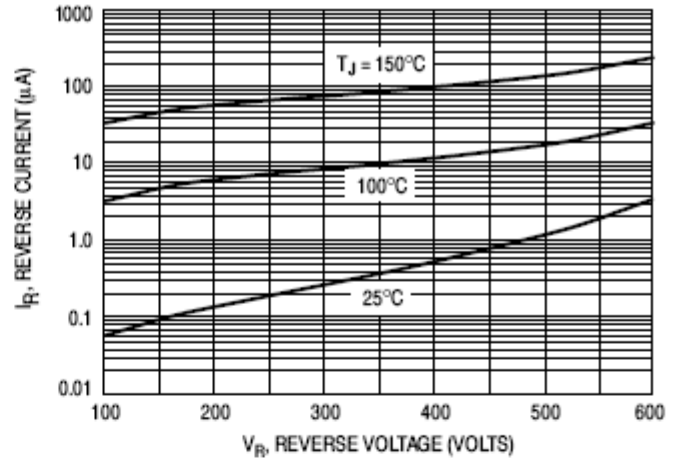

Figure 12. Typical Reverse Current\*

\* The curves shown are typical for the highest voltage device in the grouping. Typical reverse current for lower voltage selections can be estimated from these same curves if  $V_R$  is sufficiently below rated  $V_R$ .

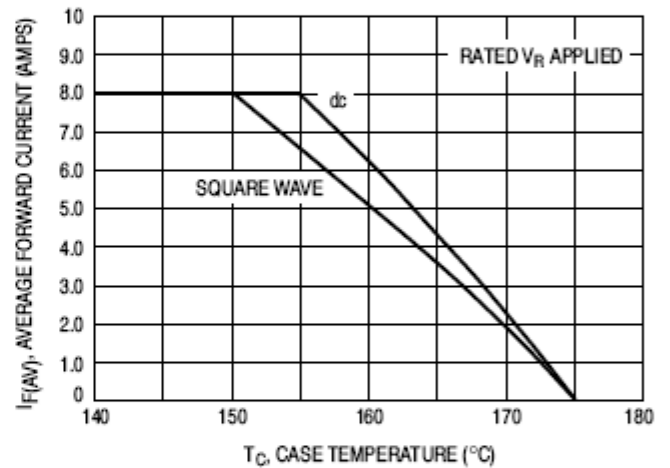

Figure 13. Current Derating, Case

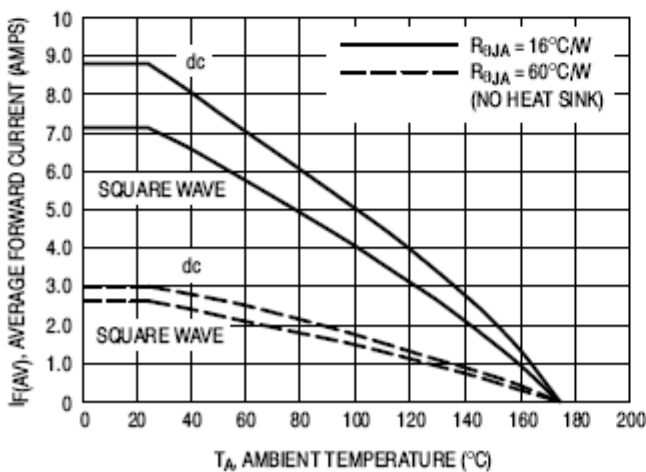

Figure 14. Current Derating, Ambient

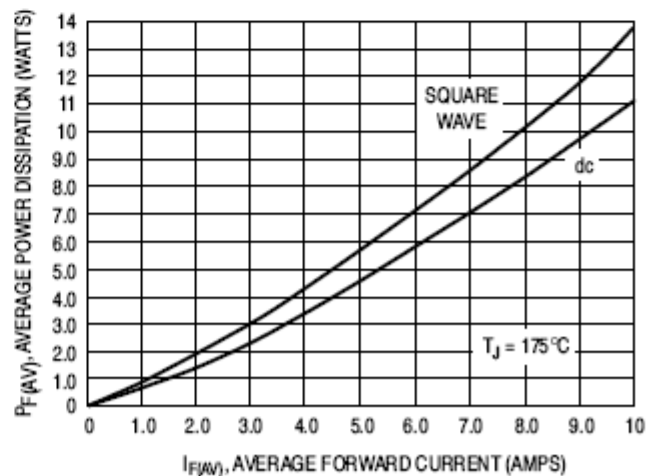

Figure 15. Power Dissipation

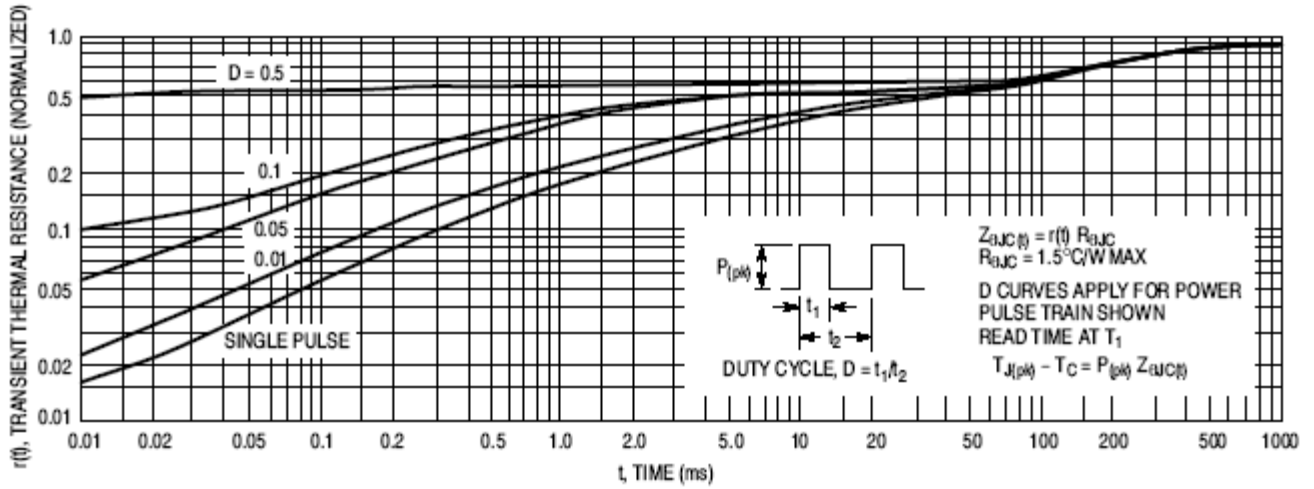

Figure 16. Thermal Response

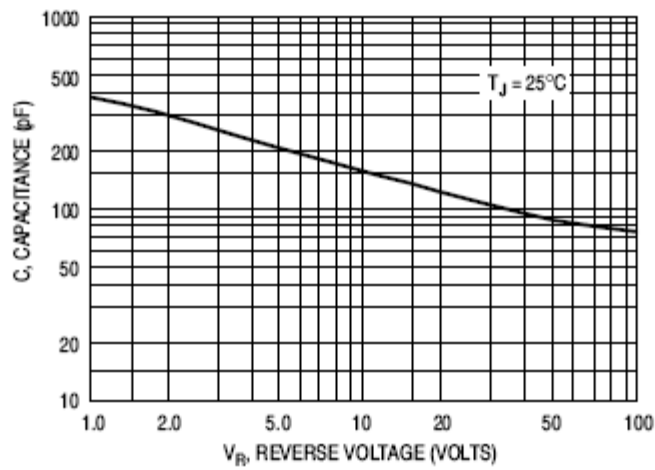

Figure 17. Typical Capacitance

## 6. Packing Specification

### 6.1 Packing Spec

	
<p>1 ) Tube : 50units</p>	<p>2) Inner Box: 20 tube(1000units)</p>
	
<p>3) Outer Box: 10 inner box (10,000units)</p>	

## 6.2 Packing Dimension

Unit: mm

Tube Dimension:

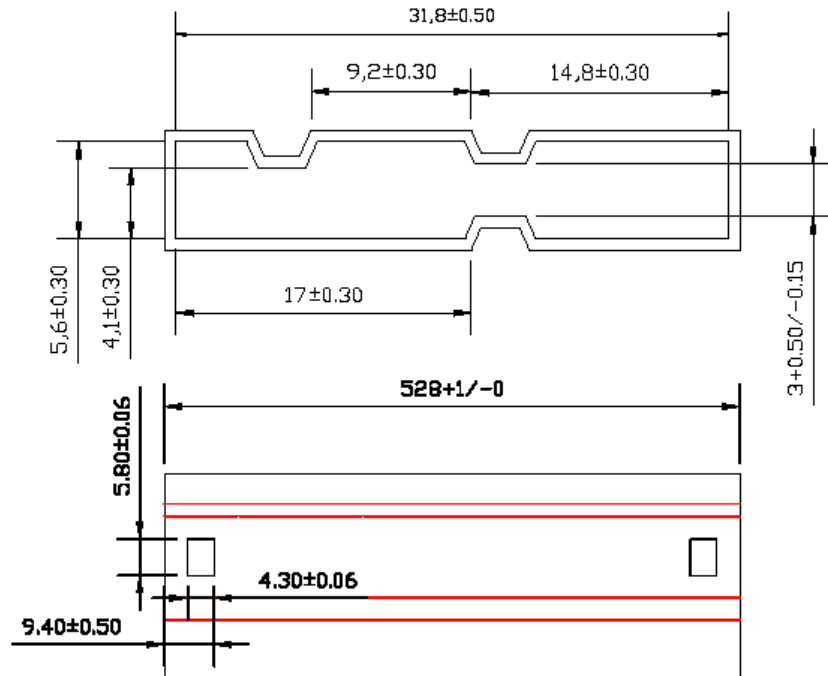

Inner Box Dimension:

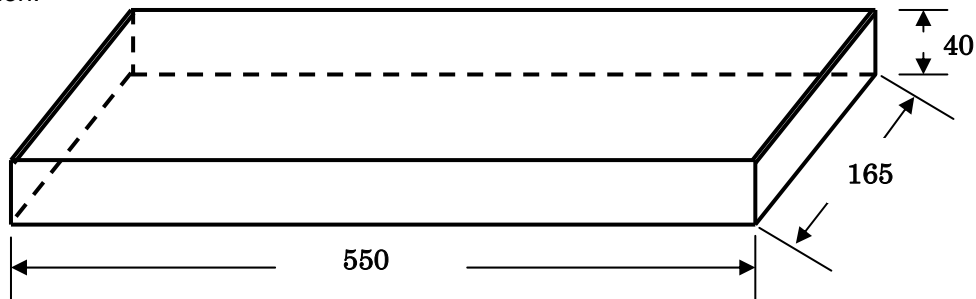

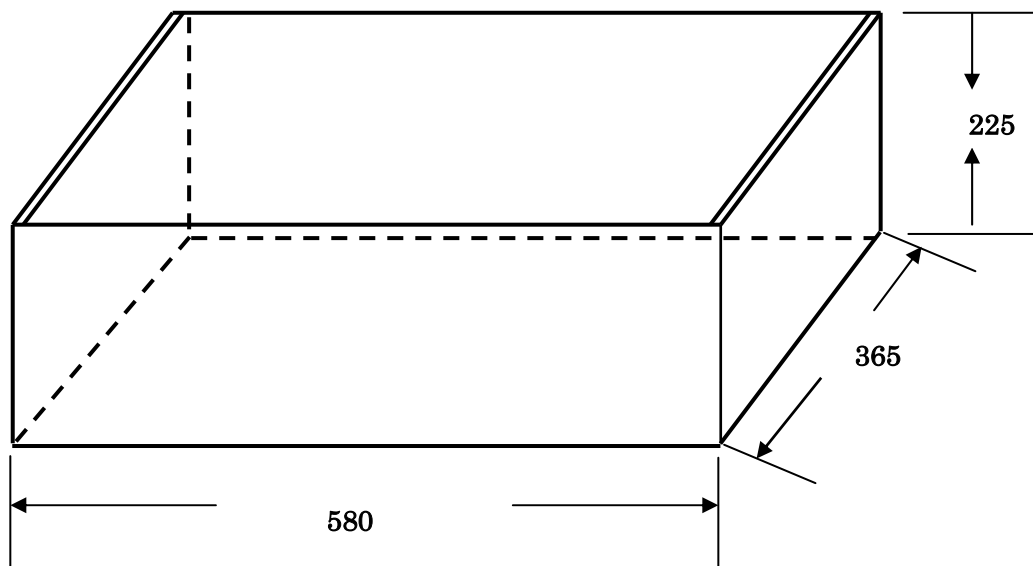

Outer Box Dimension:





7. DESCRIPTION of BOX LABEL

	<p>TYPE:          Q'TY:          P/O NO:          LOT NO:</p>
<p>1) Inner Box Label</p>	<p>2) Inner Box Label</p>
	<p>TYPE:          Q'TY:          P/O NO:</p>
<p>3) Outer Box Label</p>	<p>4) Outer Box Label</p>