

Product Specification

GOODARK Type

MBR4045CT / MBRF4045CT

Construction : Schottky Barrier Rectifier

Application : For General Purpose

(Manufacturer) :

Suzhou Goodark Electronics Co.,Ltd

Prepared on Sep. 17th, 2011

Prepared: R & D Department

Approval: QRA Department

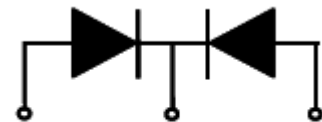

1. Anode 2.Cathode 3. Anode

CONTENTS

1. Package Outline
2. Marking
3. Features& Mechanical Characteristics
4. Maximum Ratings and Electrical Characteristics
5. Rating and characteristic Curves
6. Packing Specification PACKAGING SPECIFICATION
7. Description of Box Label

SCHOTTKY BARRIER RECTIFIER

40 AMPERES

45 VOLTS

1. Package Outline (TO220-AB)

UNIT:mm

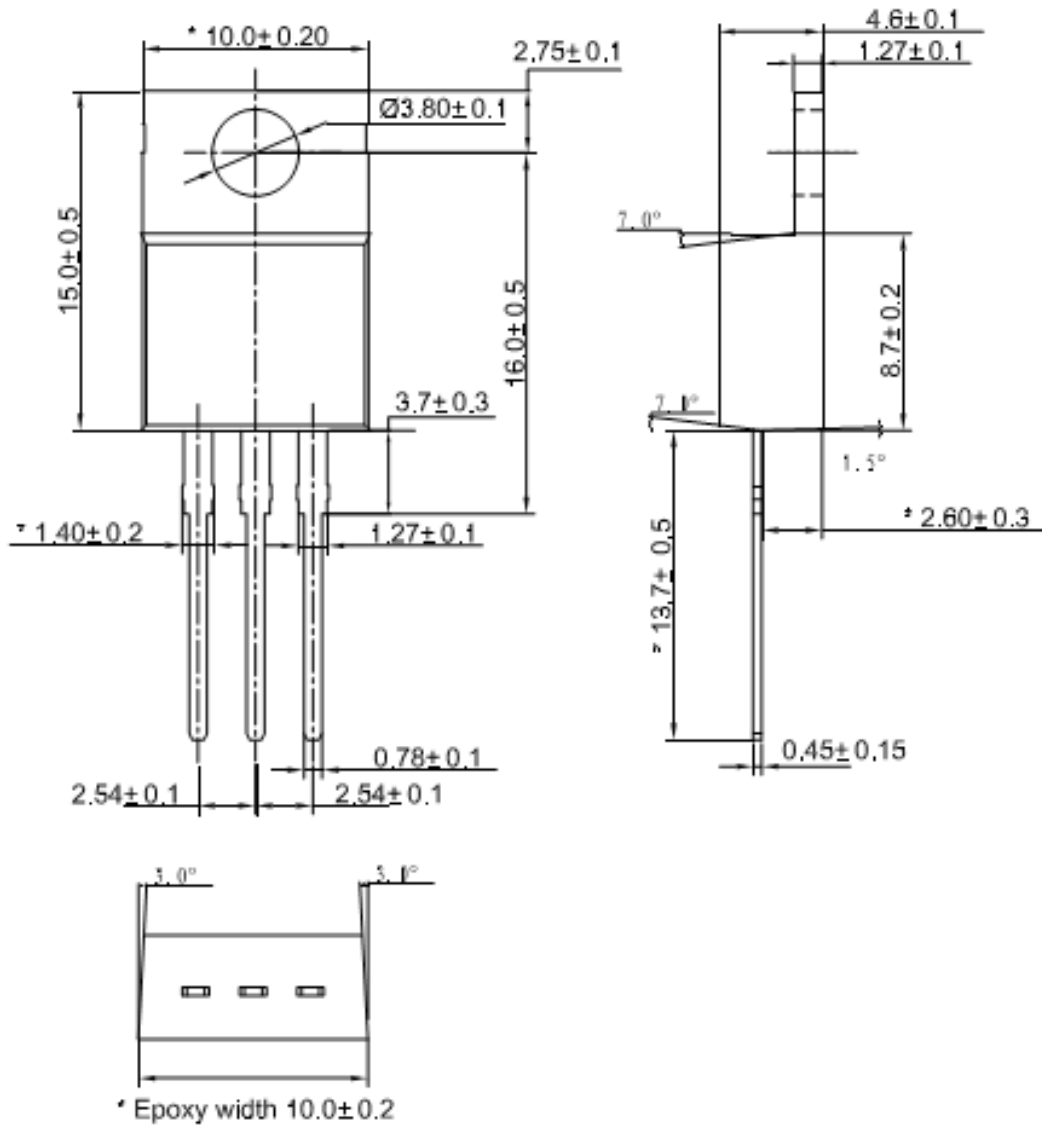

Lead Frame Material : Copper Plating: Pure Tin Plating

Package Outline (TO220F)

UNIT:mm

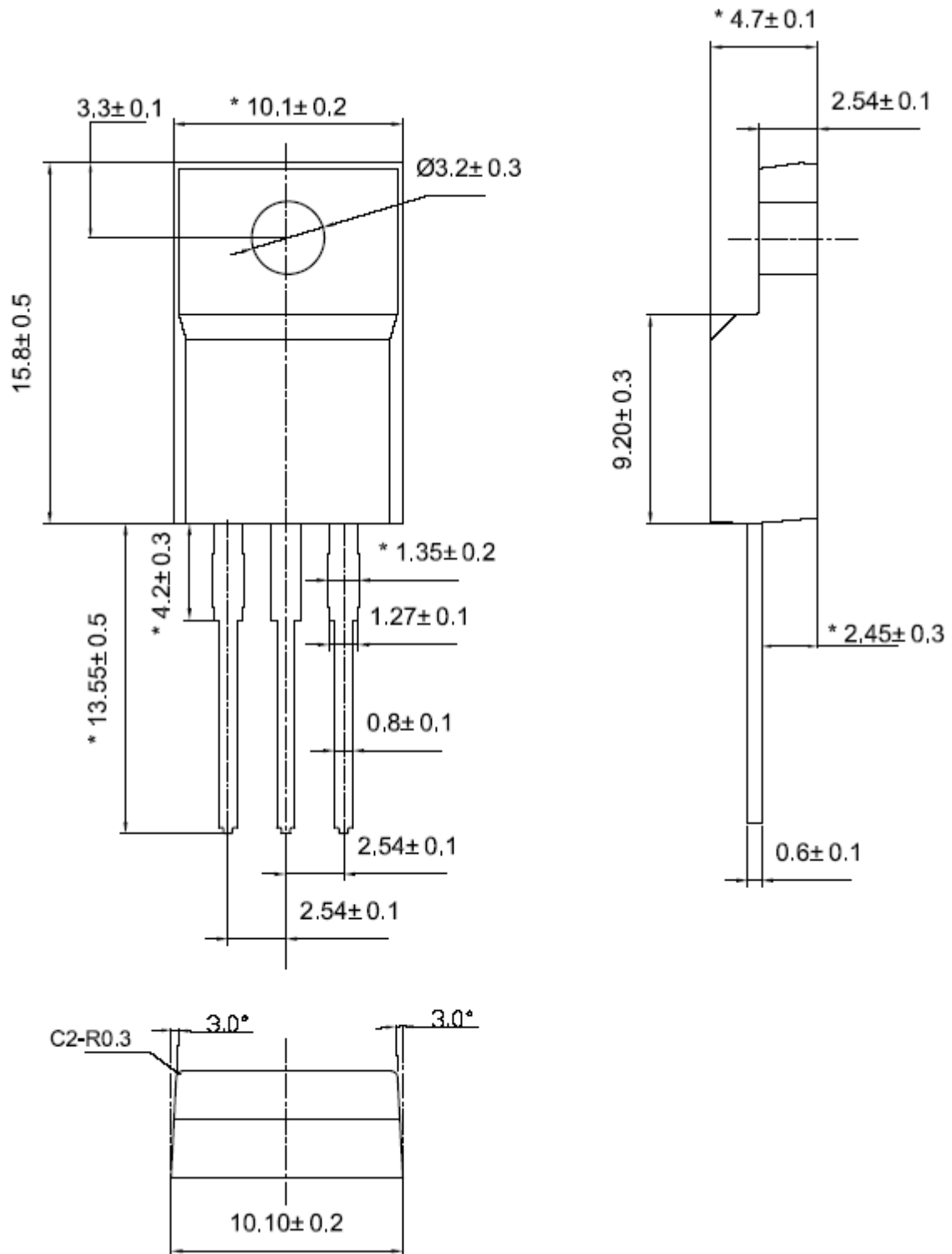

2.MARKING

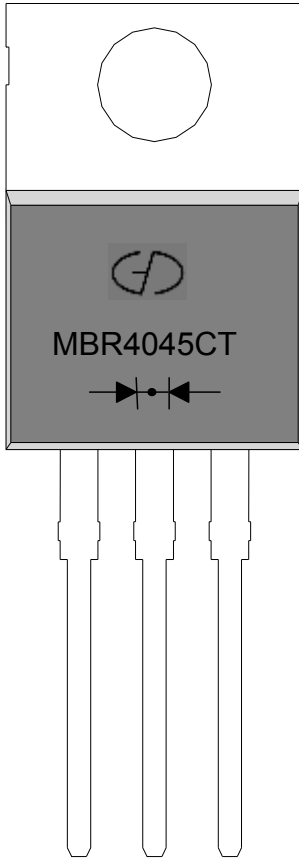

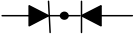
1. Part Name : MBR4045CT(TO220)
MBRF4045CT(TO220F)
2. Logo Mark: 
3. Polarity: 



3.Features& Mechanical Characteristics

Features

- Plastic package has underwriters Laboratory Flammability Classification 94V-0
- Dual rectifier construction, positive center tap
- Metal of silicon rectifier, majority carrier conduction
- Low forward voltage, high efficiency
- Guarding for over voltage protection
- For use in low voltage, high frequency inverters,
- Free wheeling, and polarity protection applications

Mechanical Characteristics

- Case: Epoxy, Molded
- Weight: 1.9grams (approximately)
- Finish: All External Surfaces Corrosion Resistant and Terminal Leads are Readily Solderable
- Lead Temperature for Soldering Purposes: 260°C Max.for10 sec
- Shipped 50 units per plastic tube

4.Maximum Ratings and Electrical Characteristics

MAXIMUM RATINGS and ELECTRICAL CHARACTERISTICS(TC=25°C unless otherwise moted)					
PARAMETER	TEST CONDITIONS		SYMBOL	MBR(F)4045CT	UNIT
Maximum repetitive peak reverse voltage			VRRM	45	V
Working peak reverse voltage			VRWM	45	V
Maximum DC blocking voltage			VDC	45	V
Maximum average forward rectified current at Tc=105°C total device per diode			IF(AV)	40 20	A
Peak forward surge current 8.3ms single half sine-wave superimposed on rated load per diode			IFSM	200	A
Peak repetitive reverse current per leg at tp=2.0us , 1KHz			IRRM	1	A
Voltage rate of change (rated VR)			DV/dt	10000	V/us
Operating junction temperature range			TJ	-55 to +150	°C
Storage temperature range			TSTG	-55 to +150	°C
Isolation voltage (TO220F only) from terminal to heatsink t = 1 min			VAC	1500	V
Maximum instantaneous forward voltage per leg	IF=20A IF=20A	TC=25°C TC=125°C	VF	0.61 0.51	V
Maximum reverse current per leg at working peak Reverse voltage	TJ=25°C TJ=100°C		IR	800 50	uA mA

Thermal Characteristics Ta=25°C unless otherwise noted

Symbol	Parameter	Max (TO220AB)	Max (TO220F)	Unit
RθJC	Thermal Resistance, Junction to Case per Leg	2.0	4.0	°C /W
RθJA	Thermal Resistance, Junction to Ambient per Leg	62.5	62.5	°C /W

Note:

1. Screw mounting with 4-40 screw, where washer diameter is ≤4.9mm(0.19 ")
2. Pulse test:300us pulse width,1% duty cycle

5. Rating and Characteristic Curves

($T_c=25^\circ\text{C}$ Unless otherwise noted)

Fig. 1 – Forward Current Derating Curve

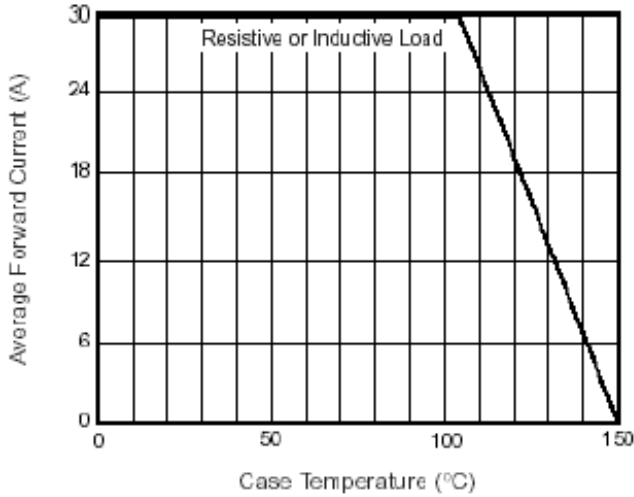

Fig. 2 – M: Peak Forward Surge Current Per Leg

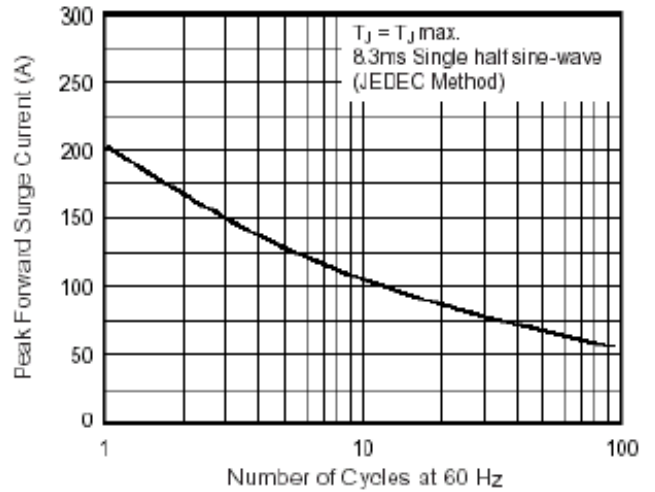

Fig. 3 – Typical Instantaneous Forward Characteristics Per Leg

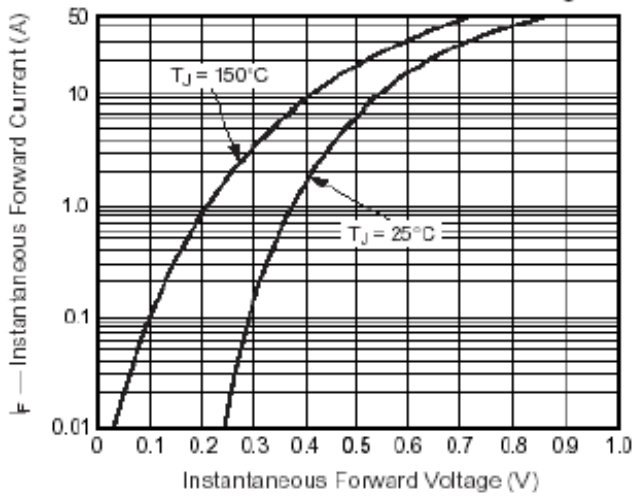

Fig. 4 – Typical Reverse Characteristics Per Leg

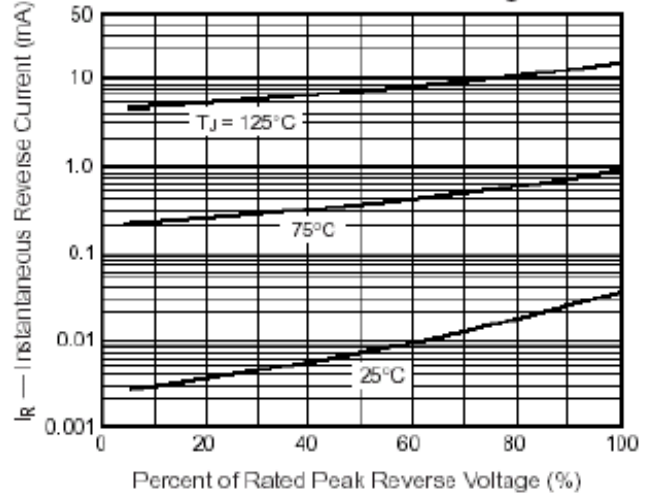

Fig. 5 – Typical Junction Capacitance Per Leg

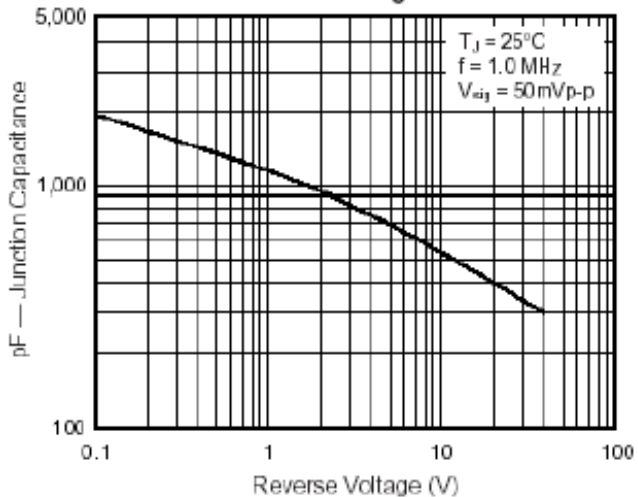
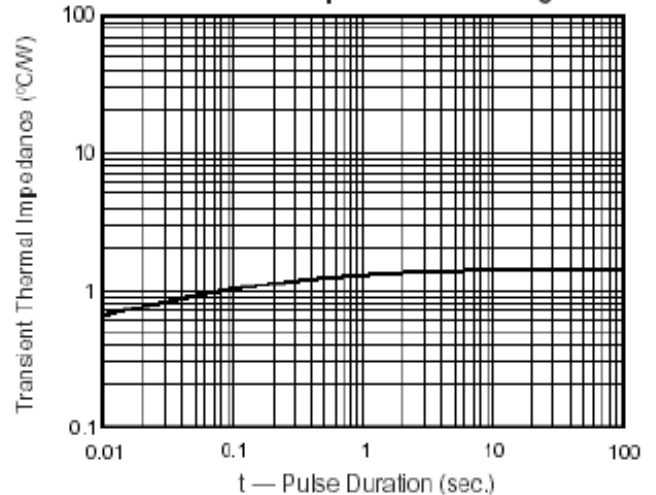







Fig. 6 – Typical Transient Thermal Impedance Per Leg



6. Packing Specification

	
<p>1) Tube : 50units</p>	<p>2) Inner Box: 20 tube(1000units)</p>
	
<p>3) Outer Box: 10 inner box (10,000units)</p>	

7. DESCRIPTION of BOX LABEL

	<p>TYPE: Q'TY: P/O NO: LOT NO:</p>
<p>1) Inner Box Label</p>	<p>2) Inner Box Label</p>
	<p>TYPE: Q'TY: P/O NO:</p>
<p>3) Outer Box Label</p>	<p>4) Outer Box Label</p>