

Features

- Schottky barrier diodes
- Low forward voltage drop
- Low leakage current
- Moisture sensitivity: level 1, per J-STD-020
- Solder dip 260 °C, 10 s
- Low profile - typical height of 1.1 mm
- Heatsink design
- High temperature soldering guaranteed: 260°C/10 seconds
- Halogen-free according to IEC 61249-2-21 definition

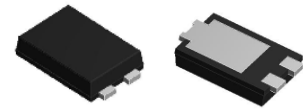

eSGC

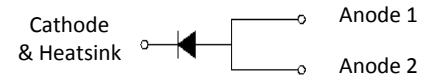

TYPICAL APPLICATIONS

For low voltage high frequency inverters, DC/DC converters and polarity protection application.

MAXIMUM RATINGS (T _A = 25 °C unless otherwise noted)			
PARAMETER	SYMBOL	SGC0560S	UNIT
Maximum repetitive peak reverse voltage	V _{RRM}	60	V
Maximum RMS voltage	V _{RMS}	42	V
Maximum DC blocking voltage	V _{DC}	60	V
Maximum average forward rectified current	I _{F(AV)} ¹⁾	5.0	A
	I _{F(AV)} ²⁾	3.0	
Peak forward surge current 8.3 ms single half sine-wave superimposed on rated load	I _{FSM}	175	A
Operating junction and storage temperature range	T _J , T _{STG}	-55 to +150	°C

ELECTRICAL CHARACTERISTICS (T _A = 25 °C unless otherwise noted)						
PARAMETER	TEST CONDITIONS		SYMBOL	TYP.	MAX.	UNIT
Instantaneous forward voltage	I _F =1A	T _A =25°C	V _F	0.40	-	Volts
	I _F =2A			0.44	-	
	I _F =5A			0.52	0.65	
	I _F =1A	T _A =75°C		0.35	-	
	I _F =2A			0.40	-	
	I _F =5A			0.50	-	
	I _F =1A	T _A =125°C		0.28	-	
	I _F =2A			0.35	-	
	I _F =5A			0.47	0.6	
Maximum DC reverse current at rated DC blocking voltage	Rated VR	T _A =25	I _R	0.04	0.2	mA
		T _A =75		0.6	3	
		T _A =125		8.7	30	
Typical junction capacitance	4.0 V, 1 MHz		C _J	220		pF
Typical thermal resistance	junction to mout pad		R _{θJM} ¹⁾	15		°C/W

Note1): Mounted on Aluminum Substrate PCB

2): Mounted on recommended copper pad area, free air.

RATINGS AND CHARACTERISTICS CURVES

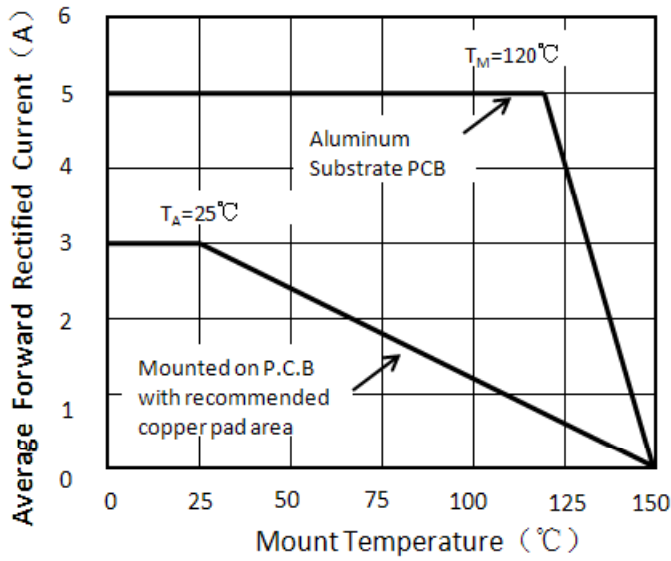

Figure 1. Forward Current Derating Curve

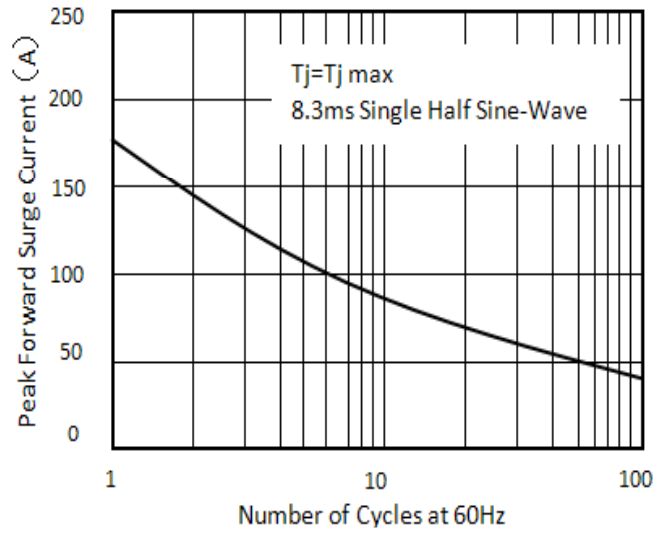

Figure 2. Maximum Non-Repetitive Peak Forward Surge Current

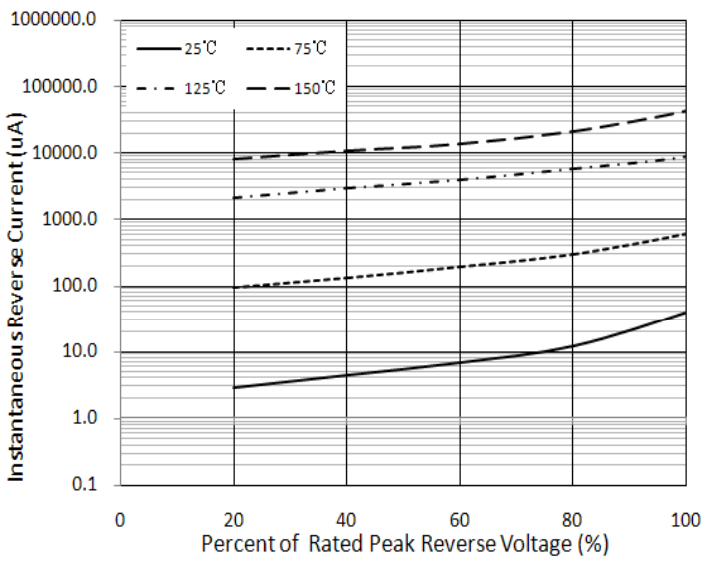

Figure 3. Typical Reverse Characteristics

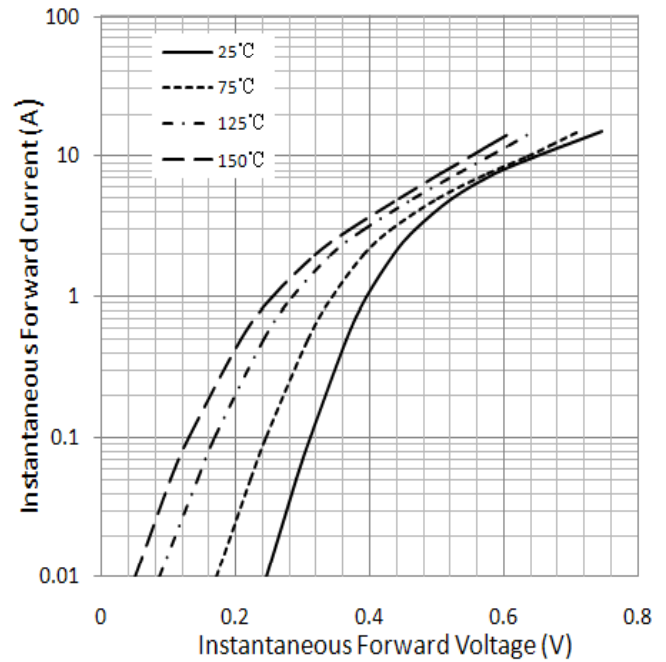
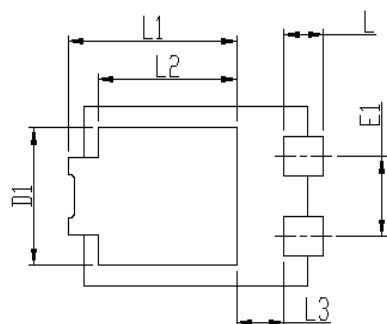
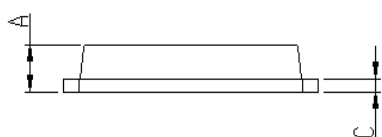
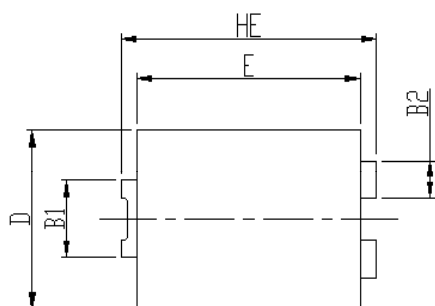

Figure 4. Typical Instantaneous Forward Characteristics

PACKAGE OUTLINE DIMENSIONS



DIM	Unit: mm		Unit: inch	
	MIN	MAX	MIN	MAX
HE	6.4	6.6	0.252	0.260
E	5.6	5.8	0.220	0.228
D	4.1	4.3	0.161	0.169
B1	1.7	1.9	0.067	0.075
B2	0.8	1	0.031	0.039
A	1.05	1.2	0.041	0.047
C	0.3	0.4	0.012	0.016
L	0.85	1.1	0.033	0.043
L1	4.2	4.4	0.165	0.173
L2	3.52 Typ.		0.139 Typ.	
L3	1.1	1.4	0.043	0.055
D1	3	3.3	0.118	0.130
E1	1.86 Typ.		0.073 Typ.	

Soldering footprint

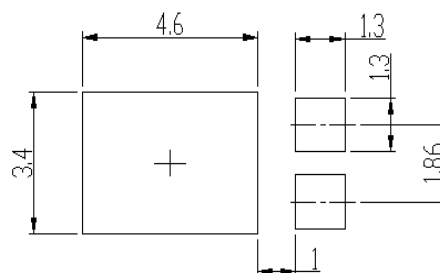

PACKING INFORMATION

Packing quantities:

5000 pcs/Reel , 12mm Tape, 13" Reel

Tape & Reel Specification

